



CONTENTS VRV Inverter K Series

GENERAL INFORMATION

1. Series Introduction	
Nomenclature	2
Indoor/Outdoor Unit Combinations	4
2. Outline of System	
1. Easily Recognizable Features of the K Series	5
2. Changes in K Series Functions / Parts	6
3. Compatibility of the Old and new VRV System Inverter	9

FUNCTIONS

1. Outdoor Unit Refrigerant System Diagram	12
2. Function of thermistors and Pressure Sensors	16
3. List of Safety Devices and Functional Parts Setting Values	17
4. Safety for Restart	18
(1) Restart Safety Timer	18
(2) Soft Start	19
(3) Pump Down Start	19
(4) Heating Lay-Up start	20
5. Equalized Oil Level Operation	20
6. Oil Return Operation	21
7. Defrost	22
8. Heating Pump Down Residual Operation	23
9. Step Down / Safety Control	24
10. Control During Low Outdoor Air Temperature Cooling	25
11. Low Noise Control	26
12. Demand Control	26
13. Compressor capacity Control	27
14. Te / Tc Setting	28
15. Gas Depletion Alarm	29
16. Drain Pump Control	30
17. Oil Temperature Sensor	32
18. Louver Control for Preventing Ceiling Dirt	33
19. Thermostat Sensor in Remote Controller	34
20. Freeze Prevention	36

TEST OPERATION

1. When Power is Turned On	38
2. Outdoor Unit PC Ass'Y	39
3. Setting Modes	40
(1) Setting Mode 1	41
(2) Setting Mode 2	42
(3) Monitor Mode	44
4. Sequential Start	46
5. External Control Adaptor for Outdoor Unit	47
6. Cool / Heat Mode Selection	49
7. Low Noise / Demand Operation	53
8. Wiring Check Operation	55
9. Indoor Unit PC Ass'Y	56
10. Remote Controllers (Wired and Wireless)	57
11. Control by Remote Controller (Double Remote Controllers, Group, Remote)	61
12. Indoor Field Setting	62
13. Centralized Control Group No. Setting	64
14. Setting of Master Remote Controller	65
15. Remote Controller Self-Diagnosis Function	66
16. Operation of the Remote Controller's Inspection / Test Operation Button	68
17. Remote Controller Service Mode	69
18. Model Change of Centralized Control Devices	71
19. Central Remote Controller	74

20. Unified ON/OFF Controller	78
21. Schedule Timer	80
22. Combining Different Types of Centralized Control Devices	82

TROUBLESHOOTING

1. Operation Flowcharts	86
2. Diagnosis by Malfunction Code	93
3. Failure Diagnosis	95
4. Failure Diagnosis for Inverter System	124
5. How to use the Monitor switch on the Inverter PC Board ...	125
6. Failure Diagnosis for Central Remote Controller	134
7. Failure Diagnosis for Schedule Timer	138
8. Failure Diagnosis for Unified ON/OFF Controller	142
9. Appendix	
(1) Precautions When Replacing K Series PC Boards	146
(2) Precautions Concerning the Remote Controller's Mode No.	146
(3) Typical wiring Mistakes	147
(4) Wiring Diagrams	151
(1) Inverter series (Heat Pump)	151
(2) Inverter Series (Cooling Only)	153
(3) Heat Recovery Series	155

Все каталоги и инструкции здесь: <https://splitssystema48.ru/instrukcii-po-ekspluatatsii-kondicionerov.html>





Все каталоги и инструкции здесь: <https://splitssystema48.ru/instrukcii-po-ekspluatácii-kondicionerov.html>





GENERAL INFORMATION

Inverter K series



Все каталоги и инструкции здесь: <https://splitssystema48.ru/instrukcii-po-ekspluatatsii-kondicionerov.html>





1. Series Introduction

NOMENCLATURE

• Indoor Unit

FXY C 40 K V1

Power supply symbol
V1: Single phase 220 to 240V, 50Hz
Indicates major design category
Capacity Indication
Conversion to horsepower:
20: 0.8HP
25: 1HP
32: 1.25HP
40: 1.6HP
50: 2.0HP
63: 2.5HP
80: 3.2HP
100: 4HP
125: 5HP
200: 8HP
250: 10HP

Type of unit
C : Ceiling mounted cassette type (Double flow)
F : Ceiling mounted cassette type (Multi flow)
K : Ceiling mounted cassette corner type
S : Ceiling mounted built-in type
M : Ceiling mounted duct type
H : Ceiling suspended type
A : Wall mounted type
L : Floor standing type
LM: Concealed floor standing type

Indicates that this is a INVERTER or HEAT RECOVERY SERIES indoor unit.





● Outdoor Unit

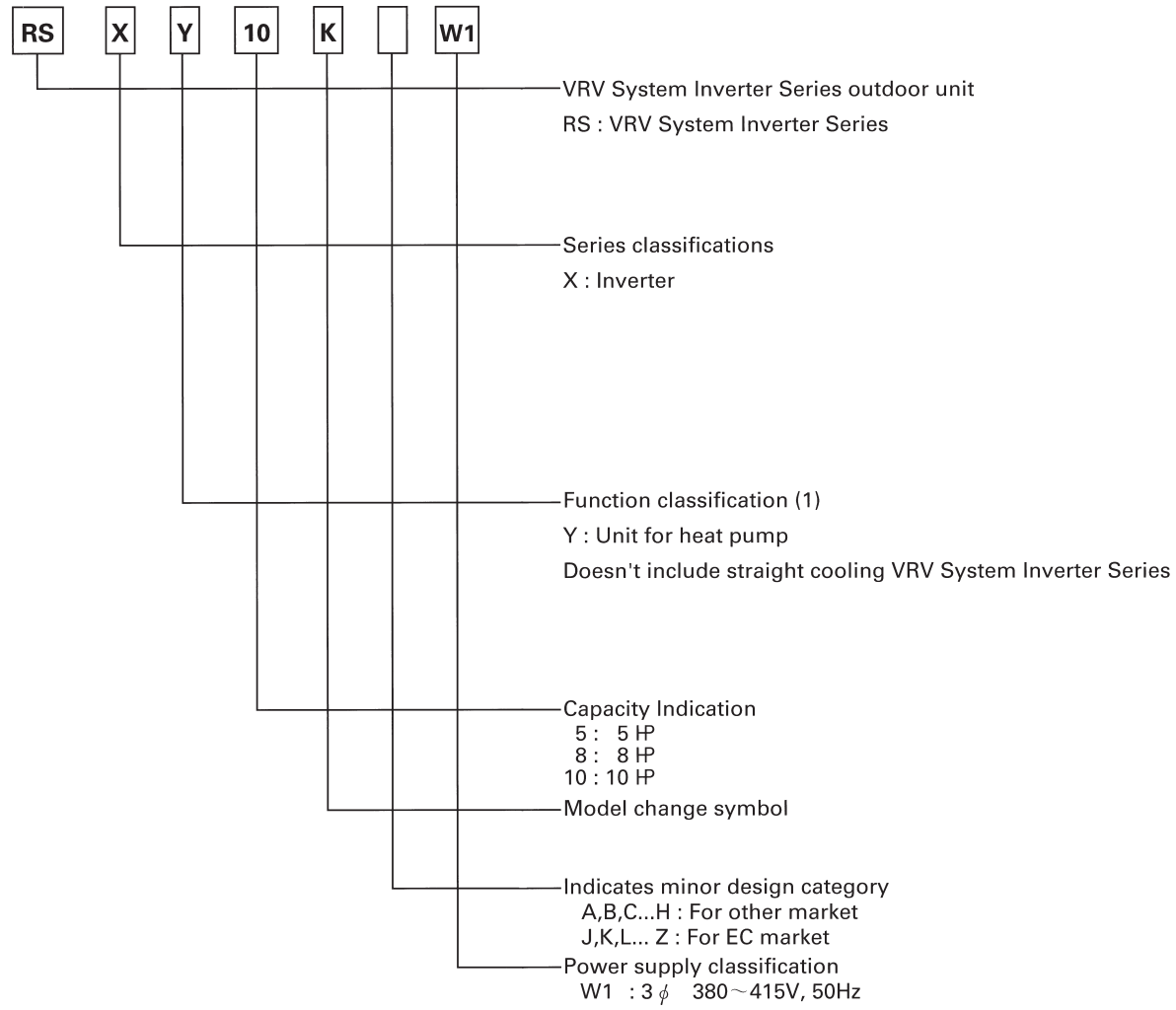



Indoor/Outdoor Unit Combinations

■ VRV System Inverter K Series

VRV System Inverter K Series outdoor unit model	RSXY5K	RSXY8K	RSXY10K
Total connectable indoor units	Max. 8 units	Max.13	Max.16

■ Straight Cooling VRV System Inverter

VRV System Inverter EXC Series outdoor unit model	RSX5K	RSX8K	RSX10K
Total connectable indoor units	Max. 8 units	Max.13	Max.16



Все каталоги и инструкции здесь: <https://splitssystema48.ru/instrukcii-po-ekspluatácii-kondicionerov.html>





2. Outline of System

1. Easily Recognizable Features of the "K" Series

VRV System Inverter K Series System Outline

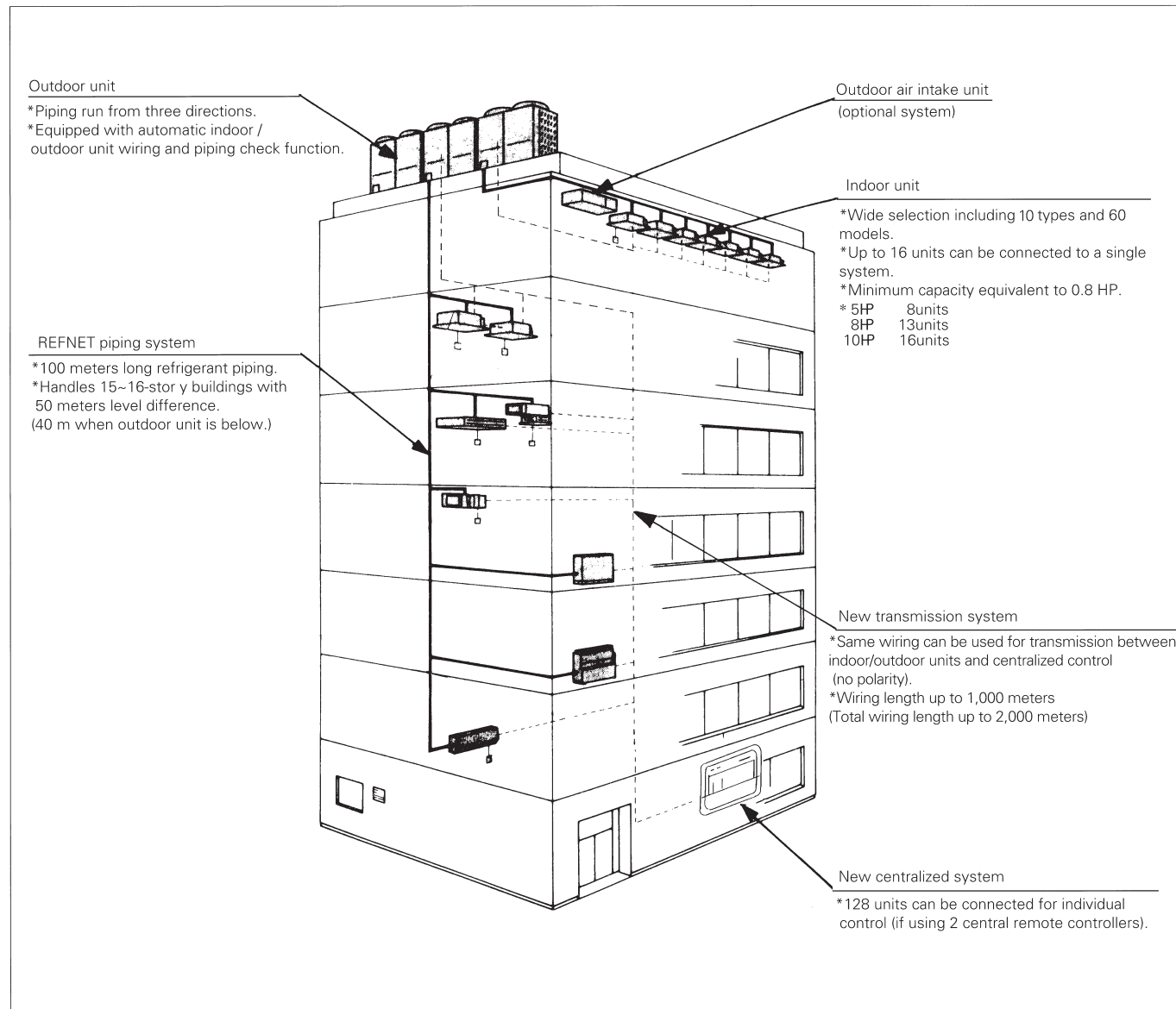

2. Changes in K Series Functions / Parts

(1) Changes in the System as a Whole

- **More outdoor units can be connected.**

A maximum of 16 indoor units can now be connected to a single system.

- 5HP 8 units
- 8HP 13 units
- 10HP 16 units

- **Same wiring can be used for transmission between indoor/outdoor units and centralized control**

Up to now, separate wiring was required for centralized control and for transmission between indoor/outdoor units when installing optional controllers for centralized control, but now the same wiring can be used for both. This facilitates indoor/outdoor transmission wiring construction work as follows.

H Series

- Separate input and output terminals.
- Has polarity.
- Only serial wiring can be used.
- Wiring can be up to 1,000 meters long.

K Series

- Same terminals used for input and output.
- No polarity.
- 3 wiring methods can be used (serial, bus and star wiring).
- Up to 16 branches can be used. (Cannot be branched again once branched.)
- System wiring can be up to a total of 2,000 meters. (Max. wiring length up to 1,000 meters).

Indoor unit terminal block

H	Input		Output		Remote controller		Centralized		Forced off	
Series	1	2	1	2	P1	P2	F1	F2	T1	T2

K	Remote controller		Transmission wiring		External	
Series	N	P	F1	F2	T1	T2

Outdoor unit terminal block

H	C / H selector			Output		Out / D unit input		Out / D unit output		Sequential start KRP 80 - 51	
Series	A	B	C	1	2	3	4	3	4	5	6

K	C / H selector			To In / D unit		To Out / D unit	
Series	A	B	C	F1	F2	F1	F2

- **2 central remote controller can be connected in a transmission system.**

VRV System Inverter K Series equipment can be connected with two central remote controllers, and can individual control 128 unit (64 units × 2) on a single transmission line.



• **Change in mode of transmission between outdoor units**

Wiring for transmission between outdoor units is necessary for selecting cool or heat mode for several units at once. This transmission has been changed as follows.

H Series

- Separate input and output terminals.
- Sequential start requires adaptor PC board.
- Simultaneous cool/heat selection and low noise operation require only wiring between outdoor units and setting.

K Series

- Same terminals used for input and output.
- Sequential start requires only wiring between outdoor units and setting.
- Simultaneous cool/heat selection and low noise operation require a separate adaptor for outside control of outdoor units.
- Transmission can be conducted between a maximum of 10 units.
- Optional controllers for centralized control can be connected to

• **VRV System Inverter K Series**

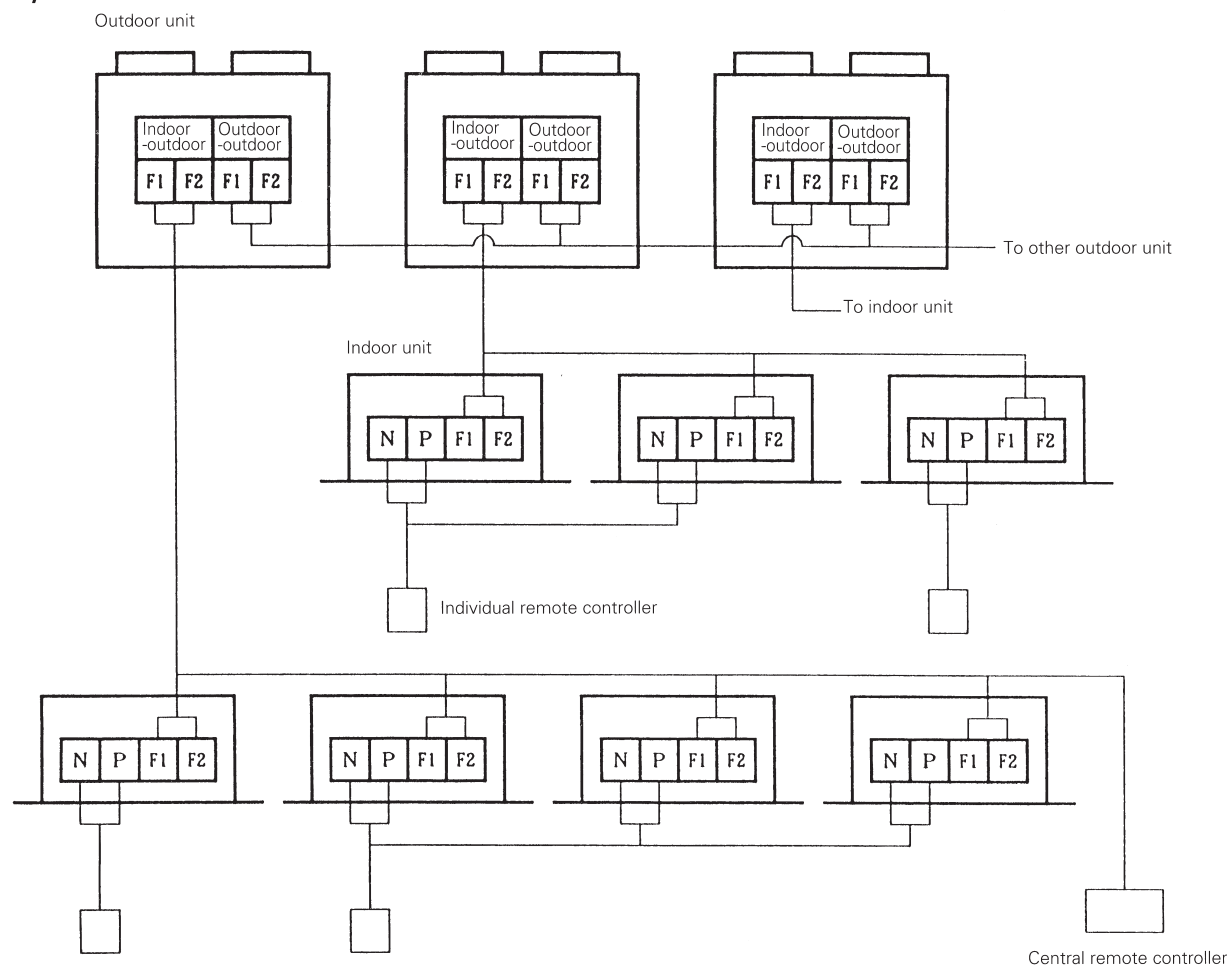



(2) Changes in Indoor Units

• Drain pump

When the TEST OPERATION button has been pushed in order to facilitate checking drainage when installing, the drain pump is force-operated regardless of the temperature control mode. If a humidifier is to be included in the setup, you must set to “using humidifier” with the remote controller. (With the factory settings, the drain pump is not operated during heating.)

• Swing louver

The wall mounted type is equipped with a swing louver . The ceiling mounted cassette type can be set to prevent the ceiling from being soiled.

• Able to use wireless remote controllers

The multi flow, double flow, ceiling suspended and wall mounted types can be fitted with a wireless remote controller kit. (Other types can use a separate wireless remote controller.)

(3) Changes in Outdoor Units

• Equipped with oil temperature sensor thermistor (8 and 10HP)

Oil temperature detection has been incorporated into control in order to prevent wet operation and improve dilution of oil.





3. Compatibility of Old and New VRV System Inverter

(1) H Series indoor units:

Cannot be connected to new outdoor unit

■ Connectable combinations

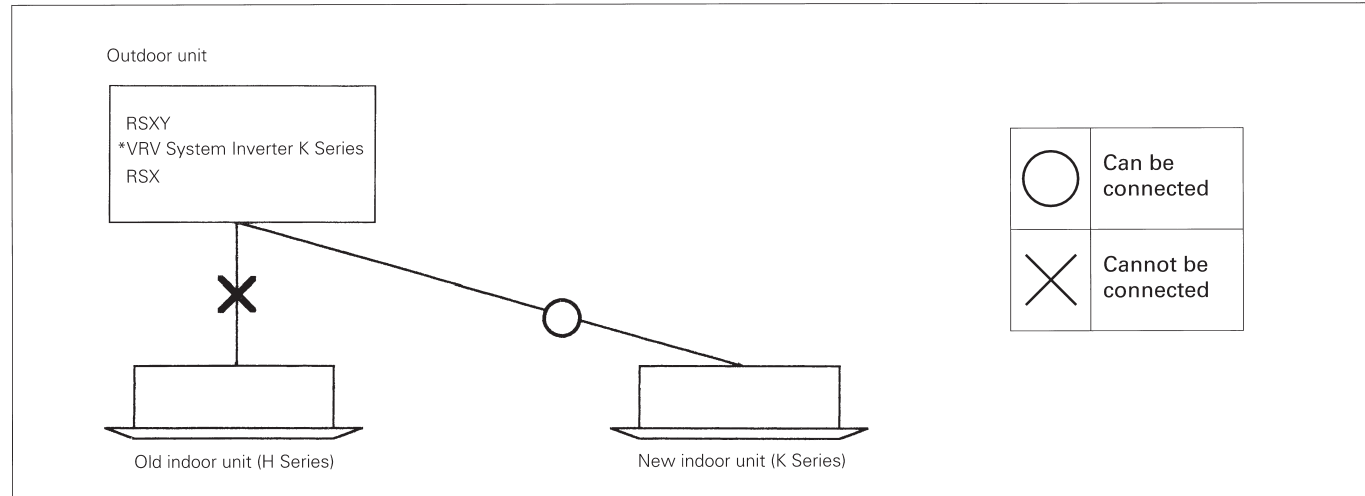

■ Notes

1. Old and new indoor units cannot be used together.

(2) The new K Series indoor unit can be connected as an extension to an existing outdoor unit using an optional accessory "Mix Matching Adaptor "K" Indoor Unit"

■ Connectable combinations

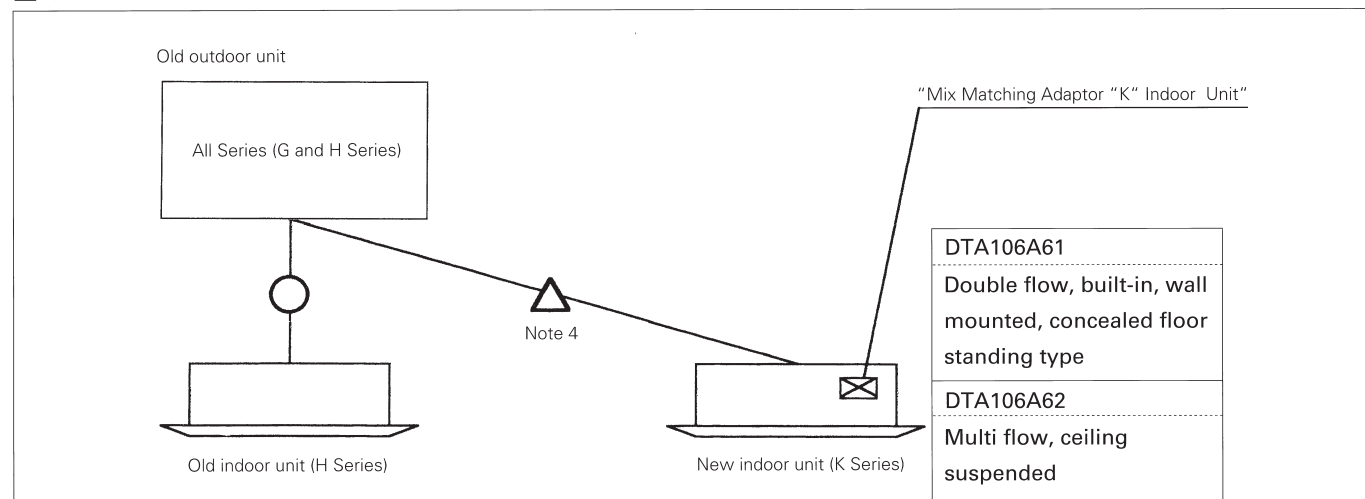

■ Notes

3. Old and new indoor units can be used together.
4. An Mix Matching Adapter for "K" Indoor Unit (DTA106A61/62) is required for one refrigerant system.





MEMO



Все каталоги и инструкции здесь: <https://splitssystema48.ru/instrukcii-po-ekspluatácii-kondicionerov.html>





FUNCTIONS

Inverter K series



Все каталоги и инструкции здесь: <https://splitssystema48.ru/instrukcii-po-ekspluatatsii-kondicionerov.html>





1. Outdoor Unit Refrigerant System Diagram

RSXY5K

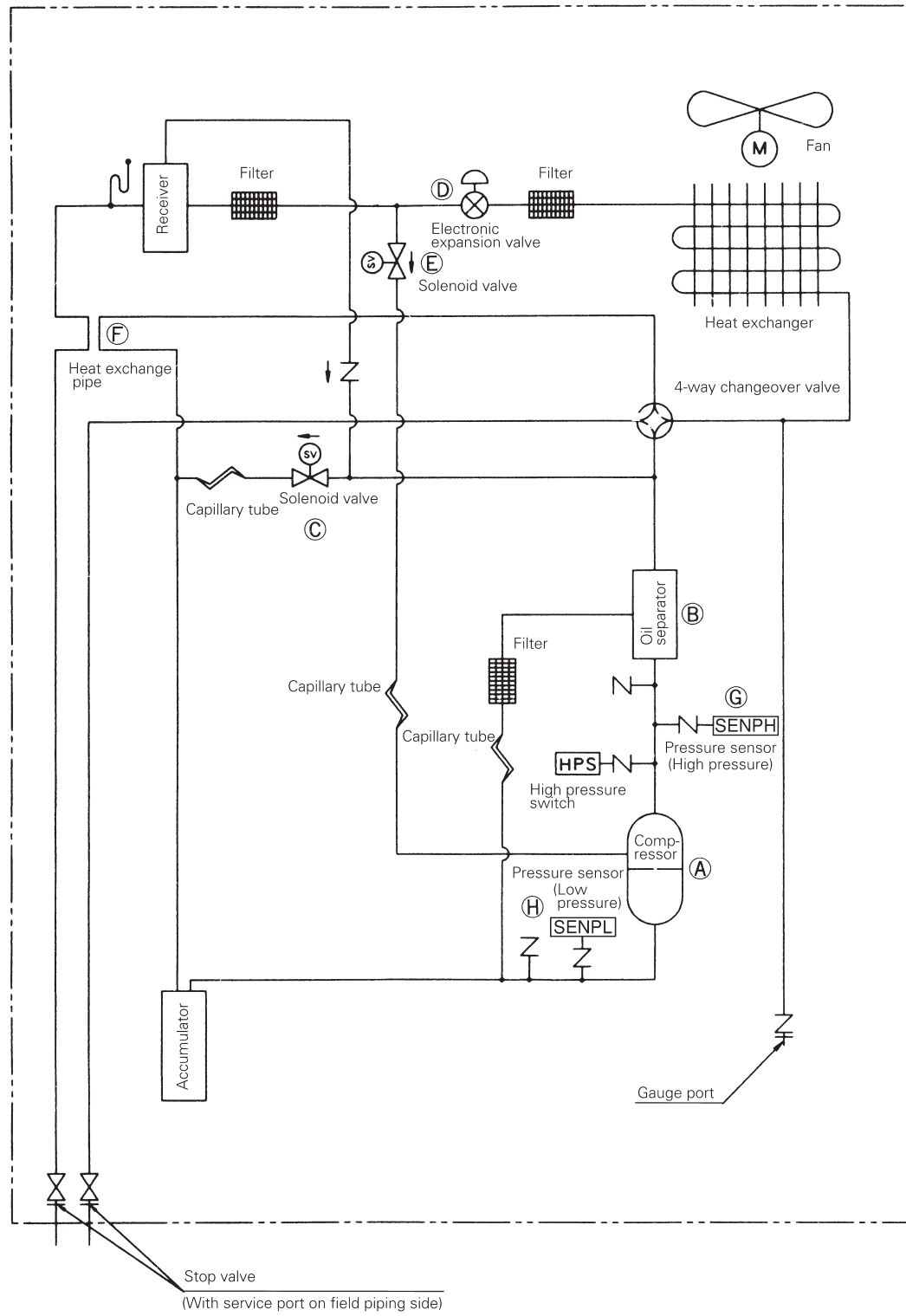

Все каталоги и инструкции здесь: <https://splitssystem48.ru/instrukcii-po-ekspluatatsii-kondicionerov.html>





A. Compressor M1C

Scroll compressor that operates on 30 ~ 116Hz by inverter drive enables 13-step capacity control. Capacity control is carried out for individual and linear control of indoor units.

B. Oil separator

The oil separator is a device that collects the oil discharged from the compressor.
The collected oil is constantly recycled to the compressor via capillary tube.

C. Solenoid valve (hot gas bypass) Y2S

Valve is opened by low pressure safety control when low pressure drops.
Balances high/low pressure when off in order to reduce load when the compressor starts.

D. Outdoor unit electronic expansion valve Y1E

Expansion valve when heating. Senses compressor suction pipe and low pressure equivalent saturated temperature, and carries out superheat degree control.

E. Solenoid valve (injection) Y3S

Controls injection in order to prevent overheating.

F. Heat exchange pipe

Subcools so that refrigerant drift doesn't occur between indoor units when flash gas is produced in the liquid pipe.

G. Pressure sensor (high pressure, red) SENPH

Semiconductor pressure sensor for sensing the operating status of the indoor by refrigerant pressure which senses discharge pressure.

H. Pressure sensor (low pressure, blue) SENPL

Semiconductor pressure sensor for sensing the operating status of the indoor by refrigerant pressure which senses suction pressure.



RSXY8,10K

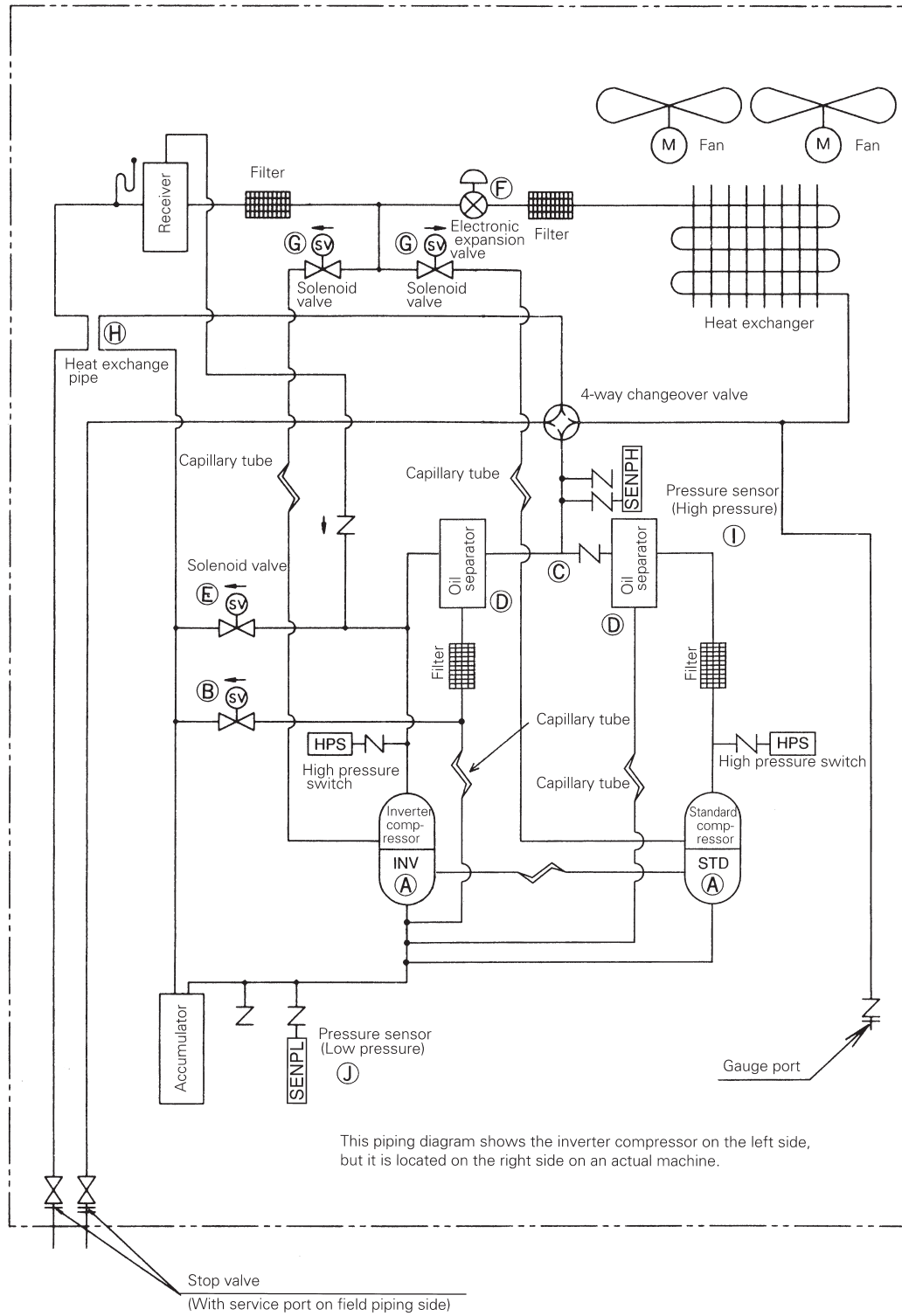

Все каталоги и инструкции здесь: <https://splitssystema48.ru/instrukcii-po-ekspluatatsii-kondicionerov.html>



A. Compressor M1C / M2C

Connecting a scroll compressor (inverter compressor) that operates on 30 ~ 116Hz by inverter drive and a scroll compressor (standard compressor) that runs on a commercial power supply to the same refrigerant system enables 21-step capacity control. Capacity control is carried out for individual and linear control of indoor units.
(M1C: Inverter compressor, M2C: Standard compressor)

B. Solenoid valve (pressure equalizing) Y1S

Balances high/low pressure when off in order to reduce load when the compressor starts.

C. Check valve

Keeps liquid refrigerant from collecting in the standard compressor when only the inverter compressor is running.

D. Oil separator

The oil separator is a device that collects the oil discharged from the compressor. The collected oil is constantly recycled to the compressor via capillary tube.

E. Solenoid valve (hot gas bypass) Y2S

Valve is opened by low pressure safety control when low pressure drops.

F. Outdoor unit electronic expansion valve Y1E

Expansion valve when heating. Senses compressor suction pipe and low pressure equivalent saturated temperature, and carries out superheat degree control.

G. Solenoid valve (injection) Y3S / Y4S

Controls injection in order to prevent overheating.
Y3S: Inverter compressor, Y4S: Standard compressor)

H. Heat exchange pipe

Subcools so that refrigerant drift doesn't occur between indoor units when flash gas is produced in the liquid pipe.

I. Pressure sensor (high pressure, red) SENPH

Semiconductor pressure sensor for sensing the operating status of the indoor by refrigerant pressure which senses discharge pressure.

J. Pressure sensor (low pressure, blue) SENPL

Semiconductor pressure sensor for sensing the operating status of the indoor by refrigerant pressure which senses suction pressure.



2. Function of Thermistors and Pressure Sensors

Outdoor unit RSXY8, 10K

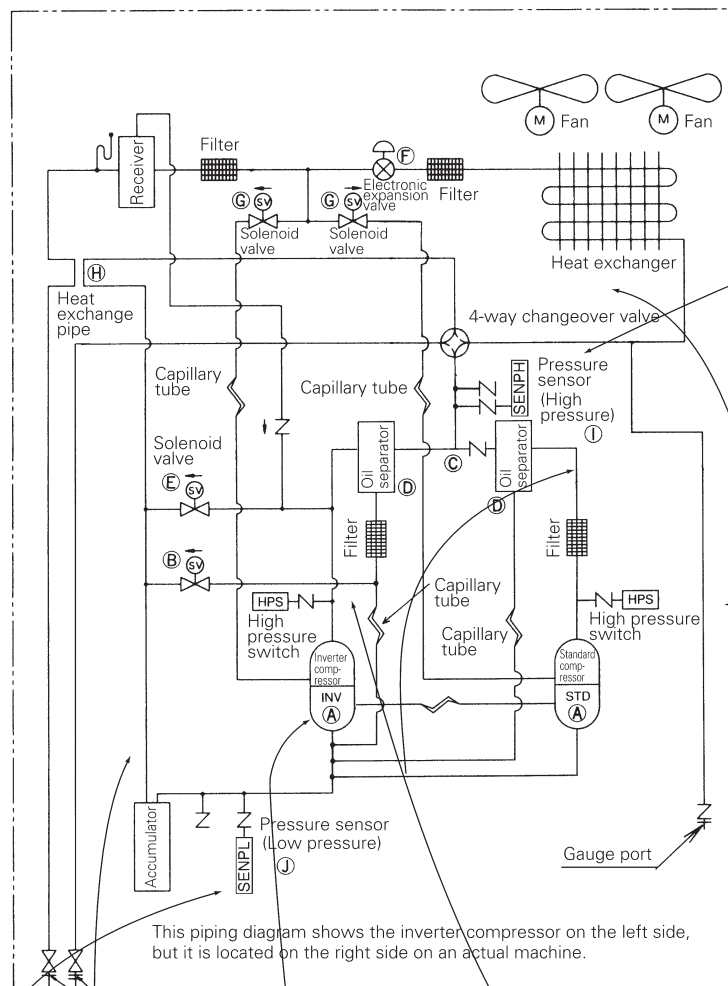

High pressure sensor (SENPH)

When heating:
Used for compressor capacity control by sensing high pressure.

When cooling:
Carries out heat exchange control during low outdoor air cooling.

Outdoor temperature thermistor (R1T)

(When heating)

- Used as the function for defrost IN conditions.
- OFF by thermostat when temperature becomes 27°C or higher

Suction pipe temperature thermistor (R4T)

Used for superheat control of electronic expansion valve when heating.

Discharge pipe temperature thermistor

R3-1T (Inverter compressor)
R3-2T (Standard compressor)
Used for compressor discharge temperature safety. (RSXY5K R3T)

Coil temperature thermistor (R2T)

(When cooling)
Not used for anything.

(When heating)
Used together with outdoor temperature as the function for defrost IN conditions.

Low pressure sensor (SENPL)

When heating:
Used for compressor capacity control and low pressure safety control by sensing high pressure.

When cooling:
Used for overheating control and low pressure safety control.

Oil temperature thermistor (R5T)

(8, 10 HP only)
(When heating)

- Alters the desired superheat degree (SH) to prevent wet operation.

(When defrosting)

- Controls upper limit frequency to improve dilution of oil.

3. List of Safety Devices and Functional Parts Setting Values

Outdoor unit RSXY5~10K

Item	Symbol	Name		Type		
				RSXY5K	RSXY8K	RSXY10K
Compressor		Inverter side	W1	JT100BAVYE 3.5 kW	JT100BAVTYE 3.5 kW	JT100BAVTYE 3.5 kW
		Model Output		JT100BATYE 2.2 kW	JT160BATYE 3.75kW	
		Standard side	—	JT100BAT 2.2 kW	JT160BAT 3.75 kW	
		Compressor safety thermostat	Discharge pipe thermistor 135°C OFF			
	J1HC/J2HC	Crank case heater	33W	33W+33W		
F2C	Over-current relay	W1	—	HOE-20F-TRA1 10A	HOE-20F-TRA1 13A	
Safety device	Q1M	Fan motor	190W		140W+230W	
	Q2M	Safety thermostat	Open 135°C±5°C	140 W: Open 120 ± 5°C, 230 W: 135 ± 5°C		
	S1P	Pressure switch (for high pressure safety)	20SP-688-6 OFF:27.5+0~-1.0kg/cm ² ON:20.0+1.0~-1.0kg/cm ²	—		
	S1HP	Pressure switch (for high pressure safety)	—	20SP - 688 - 6 OFF:27.5+0~-1.0kg/cm ² ON:20.0+1.0~-1.0kg/cm ²		
	S2HP	Pressure switch (for high pressure safety)	—	20SP - 688 - 6 OFF:27.5+0~-1.0kg/cm ² ON:20.0+1.0~-1.0kg/cm ²		
		Fusible plug	FPG-3D 70~75°C			
Sensor	SENP	Pressure sensor	PS8030A 0~30kg/cm ² (0~2.94MPa)			
	SENPL	Pressure sensor	PS8030A 0~10kg/cm ² (0~0.98MPa)			
	R1T	Thermistor (for outdoor air)	3.5~360K Ω			
	R2T	Thermistor (for heat exchange)	3.5~360K Ω			
	R3T	Thermistor (for discharge pipe)	3.5~400K Ω	—		
	R3-1T	Thermistor (for inverter discharge pipe)	—	3.5~400K Ω		
	R3-2T	Thermistor (for standard discharge pipe)	—	3.5~400K Ω		
	R4T	Thermistor (for suction pipe)	3.5~360K Ω			
	R5T	Thermistor (for inverter oil temperature)	—	3.5~400K Ω		
Other functions /parts	Y1E	Electronic expansion valve	When cooling	ON: 2,000 pulses (completely open); OFF: 0 pulses (completely closed)		
			When heating	ON: PI control; OFF: 0 pulses (completely closed)		
	Y2S	Solenoid valve (for hot gas bypass)	NEV603			
	Y3S	Solenoid valve (for auxiliary condenser)	NEV202			
	Y4S	Solenoid valve (for inverter injection)	—	NEV202		
Y1S	Solenoid valve (for standard injection)	—	NEV202			

Все каталоги и инструкции здесь: <https://splitssystema48.ru/instrukcii-po-ekspluatatsii-kondicionerov.html>

4. Safety for Restart

(1) Restart Safety Timer

When operation is turned off by thermostat sensor, the compressor will not run for five minutes in order to prevent it from being turned on and off in rapid succession, and to equalize pressure in the refrigerant circuit. It however restarts automatically after five minutes passes and operation is restarted by thermostat. The pressure equalizing solenoid valve is actuated for 10 minutes (15 minutes for 8 and 10HP heating only) after the compressor stops in order to equalize pressure.

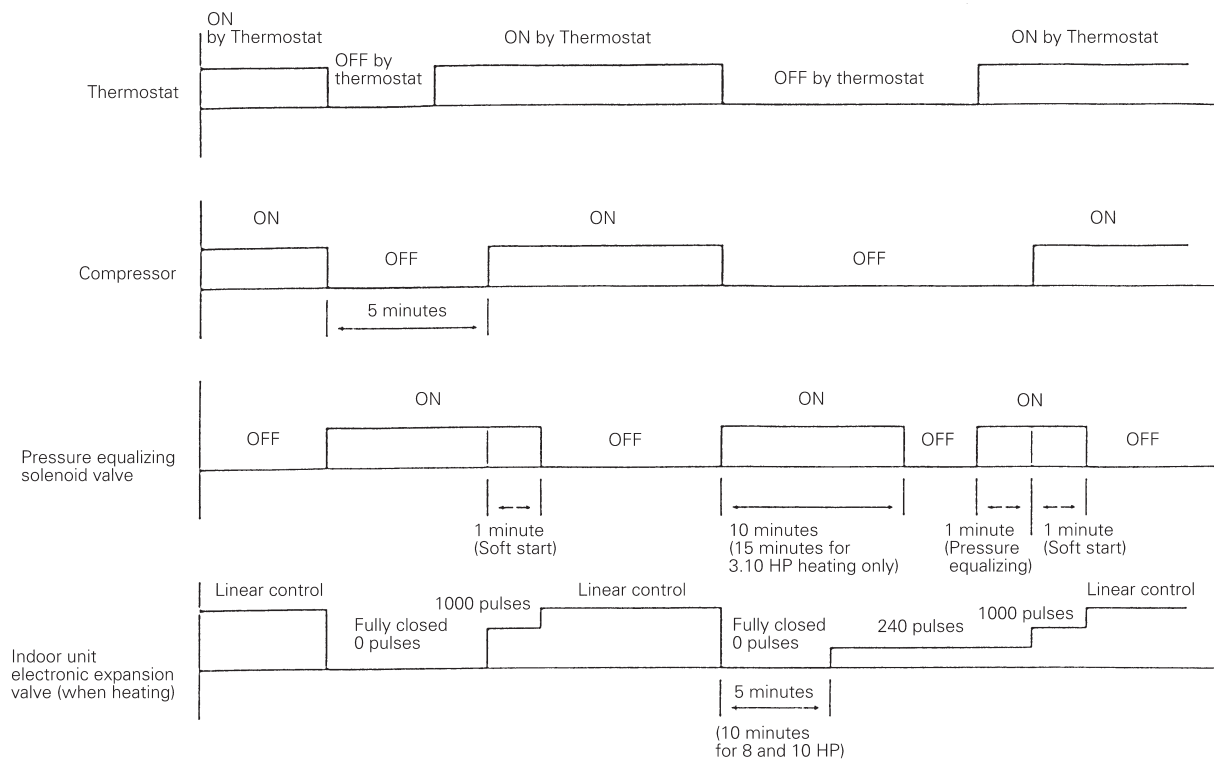

If 10 minutes or more has elapsed since the compressor was turned off (15 minutes for 8 and 10HP heating only), turn the solenoid valve for equalizing pressure on for about 1 minute and equalize the pressure.

When heating, to prevent noise produced by the passing of indoor unit's refrigerant to equalize pressure after the compressor stops, fully close the indoor unit's electronic expansion valve for 5 minutes (10 minutes for 8 and 10HP).



(2) Soft Start

The following control is carried out to protect the compressor and inverter.

- (1) Operates at low frequency (fixed) for 1 minute after compressor starts. (Prevents backflow)
- (2) Pressure equalizing and hot gas bypass solenoid valves open and start low load.

Soft start of compressor

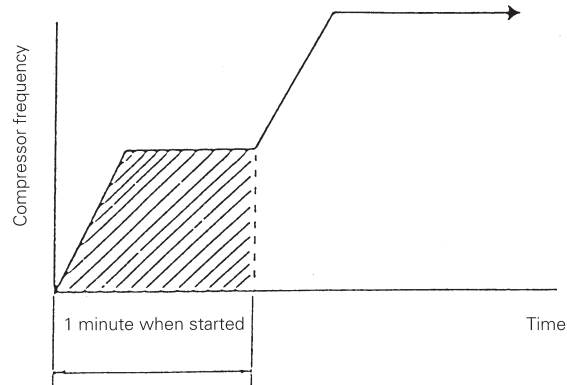

	Frequency during soft start
5K	42Hz
8,10K	42Hz+OFF

(3) Pump Down Start

If the compressor stops running with refrigerant still in the accumulator, in order to prevent wet operation the next time you start the compressor, you should perform pump down start so you can start normal operation with a completely dry accumulator.

Pump down start should be performed if the unit is in any of the conditions given below when pressure equalizing control has been completed before start.

If R3T (R3-1T) is less than 95°C and the unit is in any of the following conditions.

- Within 10 minutes of the compressor starting
- Defrosting or during oil return
- Within 20 minutes of completion of defrost or oil return
- Outdoor air temperature is less than -5°C

Operation during pump down start

	11 min. 30 sec.				
	1 min.	5 min.	30 sec.	30 sec.	4 min. 30 sec.
Compressor	42Hz (42Hz+OFF)	42Hz (42Hz+OFF)	42Hz (42Hz+OFF)		PI control ※(initial 30 Hz, upper 16Hz [116Hz + OFF])
Outdoor unit EV	0 pulses	0 pulses	0 pulses		SH control (Initial opening 150 pulses)
Outdoor unit fan	H tap (H+ON)	H tap (H+ON)	H tap (H+ON)		H tap (H+ON)
Y2S	ON	ON	ON	OFF	ON/OFF (Td protection control)
Y3S, Y4S	ON	ON/OFF (Td protection control)	ON/OFF (Td protection control)		ON/OFF (Td protection control)

※When heating, low pressure < 0.8 Kg/cm² (0.147MPa) → running frequency 54Hz (54Hz + OFF)
Low pressure > 1.1 Kg/cm² (0.167MPa) [30 sec. continuous] → release

- Y2S: Hot gas bypass solenoid valve
- Y3S: Injection solenoid valve

Все каталоги и инструкции здесь: <https://splitssystema48.ru/instrukcii-po-ekspluatatsii-kondicionerov.html>



(4) Heating Lay-Up Start

If the compressor hasn't run for a long time and the refrigerant isn't circulated, foaming could cause a lack of oil when the compressor is started the next time. You should therefore perform heating lay-up start to keep the low pressure from dropping too low in the following cases.

- When, after being started, the accumulated running time of the compressor does not exceed one hour.
- When the compressor has been stopped for more than 24 hours.

Operation during heating lay-up start

Make the compressor's upper limit frequency 60Hz (60Hz + OFF) for 10 minutes 20 seconds after the compressor starts.

※If the low pressure becomes less than 1.5Kg/cm² (0.147MPa) within 10 minutes after starting, Y2S is actuated and outdoor unit EV becomes 0 pulses. 10 minutes after start, the unit starts up as described below.

4 min. 30 sec.	
Compressor	PI control (upper limit 116Hz [116Hz +OFF])☆
Outdoor unit EV	SH control (initial opening 150 pulses)
Outdoor unit fan	H tap (H+ON)
20RP, Y25	ON/OFF (LP safety control)
20RT, Y35	ON/OFF (Td safety control)

• Y2S: Hot gas bypass solenoid valve

• Y3S: Injection solenoid valve

☆If low pressure becomes less than 0.8 Kg/cm² (0.147MPa), operating frequency becomes 54Hz.

If low pressure becomes less than 1.1 Kg/cm² (0.167MPa), the solenoid valves are released.

5. Equalized Oil Level Operation

(equalized oil level between twin compressors)

If using two compressors (8, 10Hp) connected in parallel, oil level equalizing is carried out for 5 minutes if the cumulative running time of the standard compressor exceeds 2 hours in order to prevent lack of oil cause by difference in pressure inside the dome due to drift, and then reverts to normal operation.

Inverter compressor	Standard compressor
106Hz	OFF

※If oil pressure equalization is stopped or is not achieved during 5 minutes of step down control, oil pressure is equalized when the compressor starts running.

With an inverter compressor, however, if the standard compressor remains off for 10 minutes, the cumulative running time of the standard compressor is reset.



6. Oil Return Operation

In order to collect refrigeration oil held up in connecting piping, the compressor's operating time is counted, and oil return operation is carried out for 4 minutes every 8 hours (2 hour after turning on the power supply, and every 8 hours after that). (When heating, the indoor unit's electric heater is tuned off one minute prior to oil return in preparation for oil return.)

(1) Compressor Operation Frequency

Type	Cool	Heat
5K(5HP)	106Hz	96Hz
8K(8HP)	106Hz+ON	86Hz+ON
10K(10HP)	106Hz+ON	86Hz+ON

- When heating, frequency is lower than that given in the table for the first 30 seconds and 30 seconds after completion.
- Frequency may drop according to the various types of step-down control. If so, the next oil return must be carried out 4 hours later.

(2) Opening of the electronic expansion valve

	Outdoor unit	Operating indoor unit	Indoor unit turned off
When cooling	2000 pulses (completely open)	2000 pulses (completely open)	1440 pulses
When heating	2000 pulses (completely open)	2000 pulses (completely open)	2000 pulses (completely open)

(3) 4-way changeover valve (Y1R)

- When cooling: No change
- When heating: Switches to cooling mode

(4) Fan and solenoid valve

Step No. changes according to high pressure.

Step No.	Y2S	Y3S,Y4S	Fan
①	ON※	ON	H(H+ON)
②	OFF☆	ON	L(H+OFF)
③	OFF☆	ON	OFF

(Step No. becomes higher as high pressure decreases.)

- ① → ② 30 sec. after oil return start or high pressure is less than 16Kg/cm² (1.57MPa)
- ② → ③ High pressure is less than 7.5 Kg/cm² (0.74MPa)
- ③ → ② High pressure is greater than 15 Kg/cm² (1.47MPa)
- ② → ① High pressure is greater than 20 Kg/cm² (1.96MPa)

※When heating only

☆ On when low pressure is less than 0.3 Kg/cm² (0.029MPa)

Off when low pressure is greater than 0.8 Kg/cm² (0.078MPa)

Notes)

1. If the compressor frequency continues at 68Hz (38Hz + ON for 8, 10HP) or more for eight minutes or more while defrosting and the oil return timer is counting, the timer is reset and counts again for eight hours.
2. If on standby (forced OFF by thermostat) or the compressor stops due to malfunction during oil return operation, the next time the compressor starts, oil return operation is again carried out for four minutes after completion of soft start.
3. Oil return operation is not carried out for 28 minutes after defrost is completed.



7. Defrost

• Function

Defrost operation is carried out if the relation of the outdoor unit's coil temperature (T_{coil}) and outdoor temperature (T_{air}) satisfies the conditions given below for 5 minutes continuously.

$$T_{coil} \leq C \cdot T_{air} - \alpha$$

- T_{coil} : Temperature detected by R2T
- T_{air} : Temperature detected by R1T
- C : $T_{air} < 0^{\circ}\text{C} \rightarrow 0.8$
 $T_{air} \geq 0^{\circ}\text{C} \rightarrow 0.6$

The values of (a) according to defrost temperature changeover switch are given in the table below.

Switch position LED(23 24 25 26)	L (● ● ● ○)	M (● ● ○ ●)	H (● ○ ● ●)
(deg)	12	10	8

Therefore, if outdoor temperature is 0°C :

- (1) If position L, $T_{coil} \leq -12^{\circ}\text{C}$
- (2) If position M, $T_{coil} \leq -10^{\circ}\text{C}$
- (3) If position H, $T_{coil} \leq -8^{\circ}\text{C}$

Because defrost operation is carried out, set to the "H" position if frost builds up easily, and set to "L" if not.

Factory set is position "M."

Defrost is carried out till the coil temperature rises to 12.5°C or higher, or is completed after defrosting for 10 minutes. After defrosting, indoor units carry out hot start operation and the DEFROSTING display lights until hot start is complete.

Defrost conditions are not counted from completion of power supply set-up and defrost until the compressor runs (count) for 20 minutes.

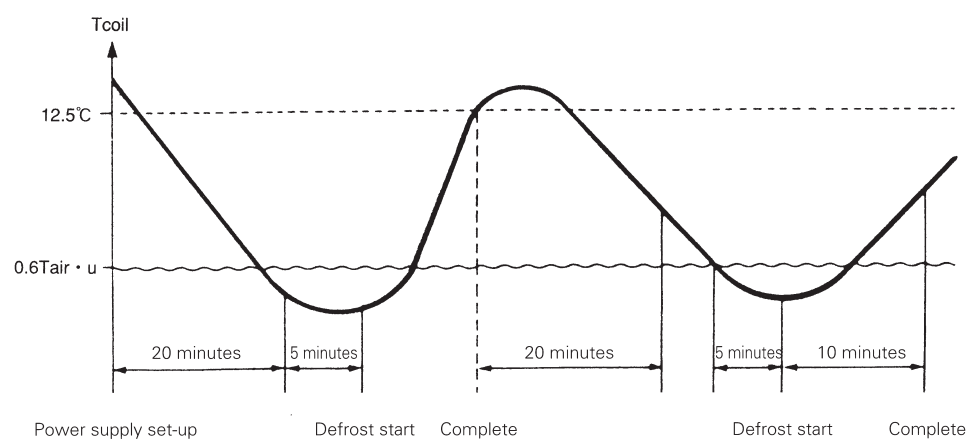

8. Heating Pump Down Residual Operation

(For RSXY 8, 10 K)

Residual operation may be carried out for 10 minutes under the following conditions when heating.

- (1) When outdoor temperature (R1T) is greater than or equal to -5°C and inverter discharge pipe temperature (R3-1T) is less than 95°, and a OFF by thermostat command is received with the compressor's continuous operation time being 10 minutes or less, residual operation is carried out for a maximum of 10 minutes.

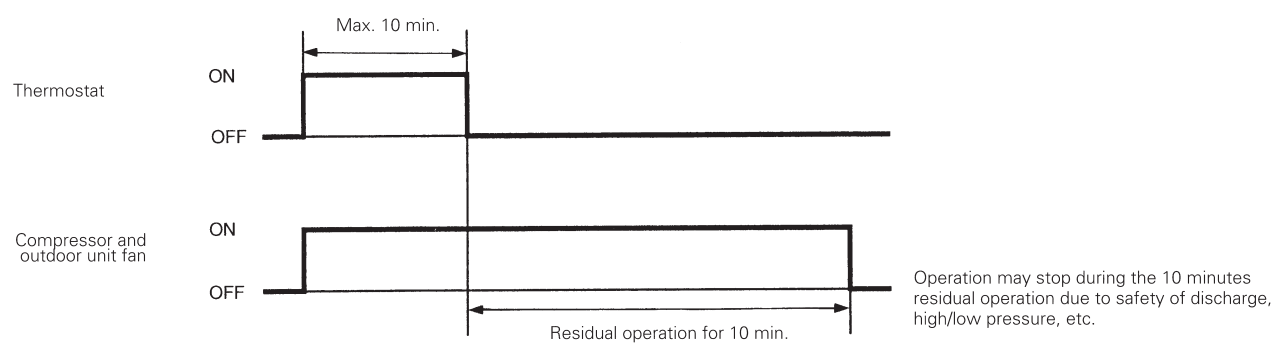

- (2) When the thermostat is ON during residual operation, residual operation is not carried out if the total of (1) + (2) + (3) is 10 minutes or more.

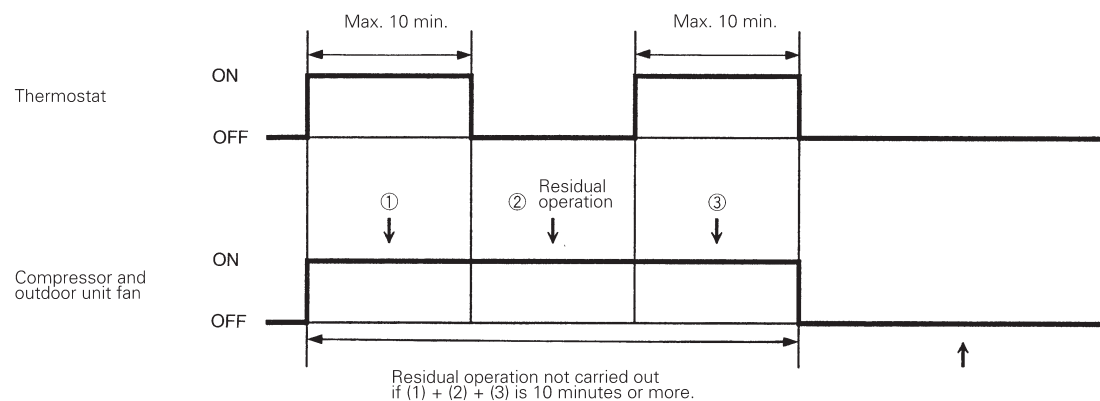

- (3) When outdoor temperature (R1T) is less than -5°C and a stop command is received from the thermostat sensor, etc., residual operation is carried out for 10 minutes without fail. (Operation may however stop for discharge pipe or high/low pressure safety.)

Outdoor unit function

Outdoor air (Th1)	Compressor	Electronic expansion valve	Pressure equalizing solenoid valve	Time
Less than ~10°C	86Hz+OFF	0 ~ 300 pulses	ON or OFF	10 min.
Less than 0°C	76Hz+OFF	0 ~ 300 pulses	ON or OFF	10 min.
0°C or higher	60Hz+OFF	0 ~ 300 pulses	ON or OFF	10 min.

Notes)

- Compressor upper limit is 116Hz + OFF for 10 minutes of next start after entering residual operation.
- During defrost or oil return, residual operation is not carried out even if a stop command comes.
- Forced OFF by thermostat occurs if defrost or oil return comes during residual operation.

9. Step Down / Safety Control → Standby (Forced Thermostat OFF) → Stop Due to Malfunction

(1) High pressure (Hp) control

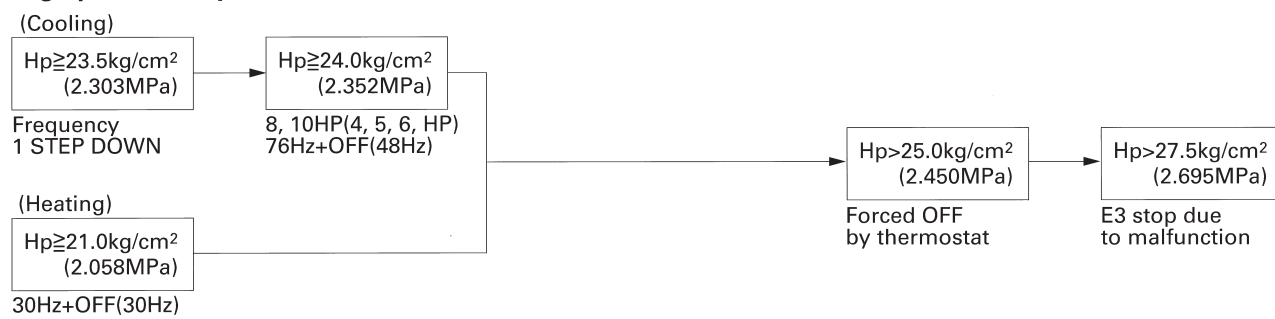

(2) Low pressure (Lp) control

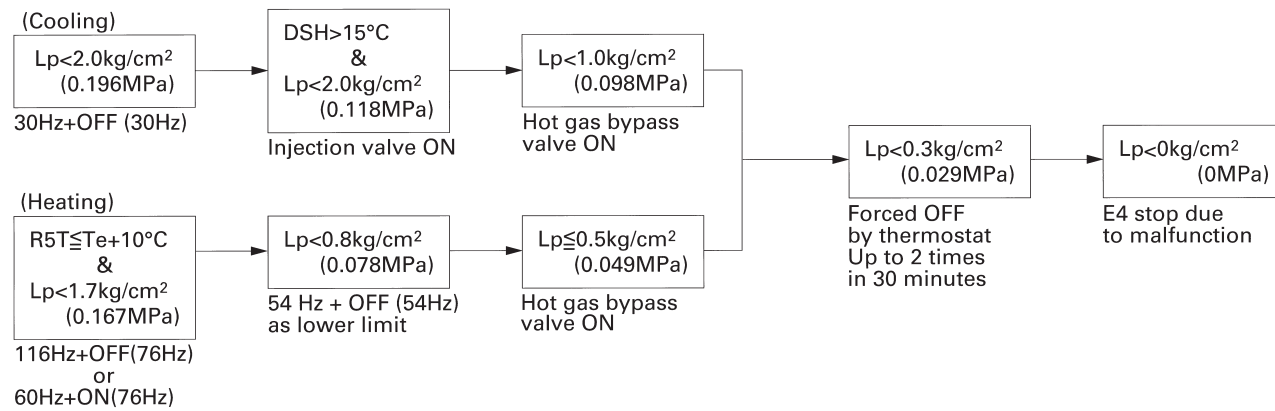

(3) Discharge pipe temperature (Td) control

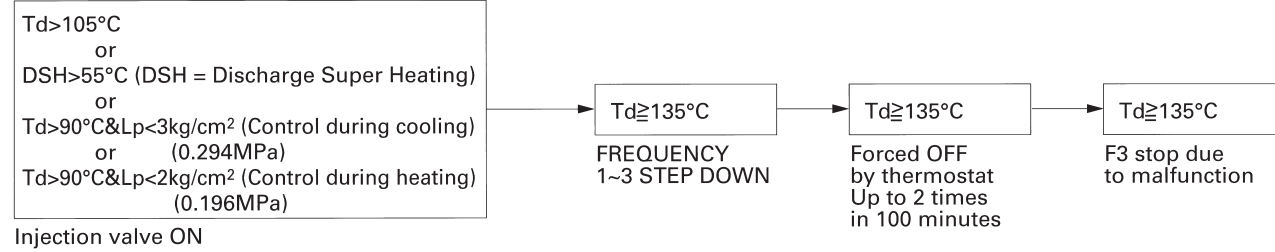

(4) Inverter current control



(5) Discharge super heating (DSH) control

(DSH = T_d - high pressure condensation saturation temperature)

When both the inverter and standard compressors are running, if the injection valve for either one goes OFF, and super heating (DSH) continues for 10 minutes at temperature difference of less than 10°C, and the inverter compressor is controlled at 76 Hz or less for 3 minutes.

(6) Control according to outdoor temperature

If the outdoor temperature exceeds 27°C when heating, forced OFF by thermostat is carried out in order to prevent a safety device from being tripped or a sensor malfunction.

10. Control During Low Outdoor Air Temperature Cooling

- When cooling when the outdoor air temperature is low in cooling, outdoor unit fans, electronic expansion valve and compressors are controlled as follows in order to primarily maintain high pressure and to check drop in refrigerant circulation caused by drop in high pressure.

RSXY5K

Operating status		Electronic expansion valve	Fan	Frequency (Hz)
Normal operation		Completely open	H	Changes according to operating status
Low outdoor temperature cooling operation	Step 1	Completely open	L	76
	Step 2	Completely open	OFF	48

RSXY8,10K

Operating status		Electronic expansion valve	Fan		Frequency (Hz)	
			M1F	M2F	8K	10K
Normal operation		Completely open	H	ON	Changes according to operating status	
Low outdoor temperature cooling operation	Step 1-1	Completely open	L	ON	96	116
	Step 1-2	Completely open	H	OFF	86	106
	Step 1-3	Completely open	L	OFF	76	96
	Step 2	Completely open	OFF	OFF	60	76

NOTE: Step No. changes according to high pressure, low pressure and frequency.
(Step No. increases with high pressure and reduction of low pressure.)

• Low outdoor air cooling IN conditions (Steps 1-1, 1-2, 1-3)

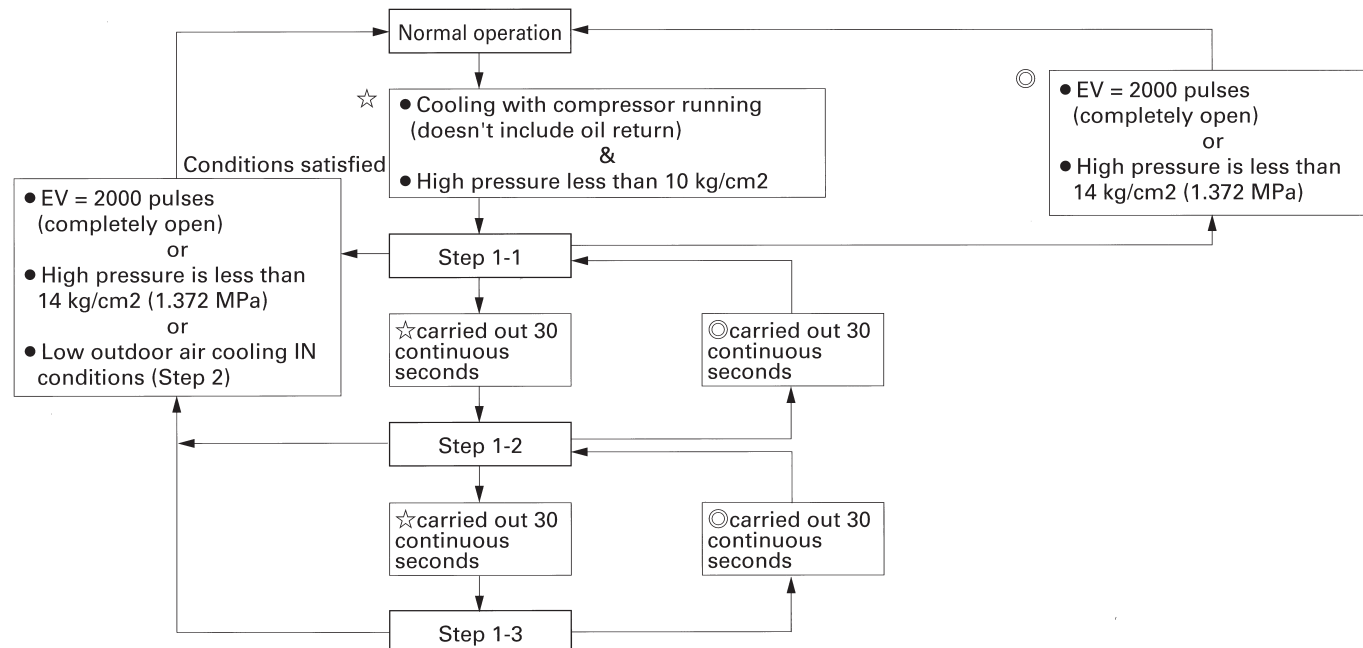

• Low outdoor air cooling IN conditions (Step 2)

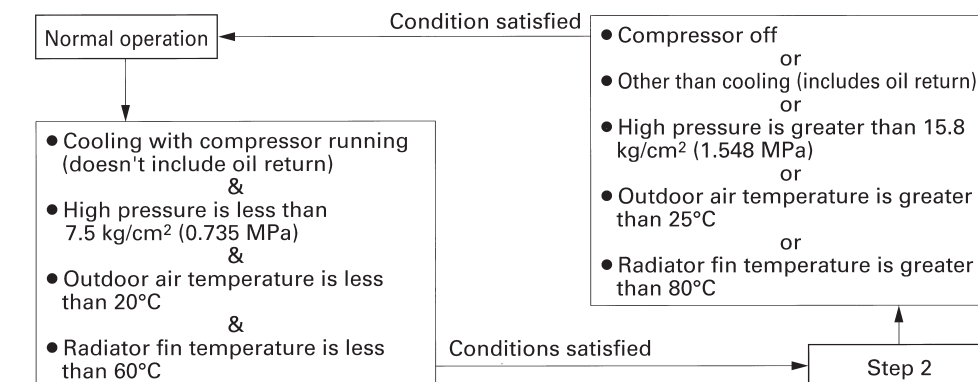

Все каталоги и инструкции здесь: <https://splitssystema48.ru/instrukcii-po-ekspluatatsii-kondicionerov.html>

11. Low Noise Control

If sound produced by outdoor units is a problem at night, etc., you can reduce the running noise by 2 to 3 dB by running the outdoor unit fans and compressors at low speed via contact input (low noise input) from outside. Operation (contact short circuit) is as follows when low noise input is received while the compressor is running (except when defrosting or oil return is being carried out).

		5k (5,HP)	8K (8HP)	10K (10HP)
Outdoor unit fan	step ①	L tap	H tap + OFF	
	step ②	L tap	L tap + OFF	
Compressor		60Hz	86Hz+OFF	96Hz+OFF

- When cooling: Step (1) → (2) high pressure > 24 kg/cm² (2.35 MPa)
Step (2) → (1) high pressure < 19 kg/cm² (1.86 MPa)

- Low noise control reduces capacity by limiting the fan and compressor. The load when heating is particularly large at night when the outdoor temperature is low, and could result in insufficient capacity.
- During low noise control, retry is unlimited for standby (forced OFF by thermostat) produced by high pressure, low pressure or discharge pipe temperature.
- An optional adaptor for outside control of outdoor units is required for low noise control. For method of connection, see low noise operation in the test operation section.

12. Demand Control

There are three modes of demand operation which controls forced capacity save for outdoor units via contact input (demand input) from outside in order to control demand.

- (1) Demand 1: Holds demand down to approx. 70%
- (2) Demand 2: Holds demand down to approx. 40%
- (3) Demand 3: Forced OFF by thermostat

- An optional adaptor for outside control of outdoor units is required for low noise control. For method of connection, see low noise operation in the test operation section.
- Control is carried out by limiting the upper limit for frequency of demand 1 and demand 2 as given in the table below.

	5HP	8HP	10HP
Demand 1	68Hz	48Hz+ON	60Hz+ON
Demand 2	34Hz	60Hz+OFF	76Hz+OFF
Demand 3	Forced OFF by thermostat		



13. Compressor Capacity Control

1. RSXY5K

Pressure is sampled every 20 seconds by pressure sensor, and the inverter compressor is controlled in 13 stages by microcomputer.
Frequency range: 34 - 116 Hz (13 stages)

Frequency	Min. output
30Hz	↑ ↓
34Hz	
38Hz	
42Hz	
48Hz	
54Hz	
60Hz	
68Hz	
76Hz	
86Hz	
96Hz	
106Hz	
116Hz	
	Max. output

2. RSXY8, 10K

Pressure is sampled every 20 seconds by two pressure sensors, and the inverter compressor is controlled in 21 stages by microcomputer.

Commercial power supply compressor (off)	Commercial power supply compressor (full load)	Min. output ↑ ↓ Max. output
Frequency	Frequency	
30Hz+OFF		
34Hz+OFF		
38Hz+OFF		
42Hz+OFF		
48Hz+OFF		
54Hz+OFF		
60Hz+OFF		
68Hz+OFF		
76Hz+OFF		
86Hz+OFF		
96Hz+OFF		
106Hz+OFF		
	38Hz+ON	
	48Hz+ON	
	60Hz+ON	
	76Hz+ON	
	86Hz+ON	
	96Hz+ON	
	106Hz+ON	
	116Hz+ON	



14. Te / Tc Setting

You can alter the value of setting mode 2 targets Te (evaporating pressure equivalent temperature) and Tc (condensing pressure equivalent temperature). PI control is used to control compressor capacity so that Te when cooling and Tc when heating are constant.

Te setting	Set temperature
High	8.5 °C
Standard	5.5 °C
Low	2.5 °C

- Target Te changes according to compressor operating frequency, length of piping and indoor load. The range is $-10^{\circ}\text{C} \leq \text{target Te} \leq 5.5^{\circ}\text{C}$. (Piping length is determined automatically during oil return operation.)

Tc setting	Set temperature
High	49 °C
Standard	46 °C
Low	43 °C

- Target Tc becomes 3°C higher when indoor load is large. Target Tc is controlled in accordance with the following conditions:
- Outdoor temp. $> 10^{\circ}\text{C} \rightarrow \text{target Tc} \leq 46^{\circ}\text{C}$
- Outdoor temp. $\leq 10^{\circ}\text{C} \rightarrow \text{target Tc} \leq 49^{\circ}\text{C}$
- Target Tc is 43°C when high pressure is greater than 17 kg/cm² (1.67 MPa) and low



15. Gas Depletion Alarm

An alarm (U0) is given for severe gas depletion. Alarm is indicated but operation continues.

(When cooling)

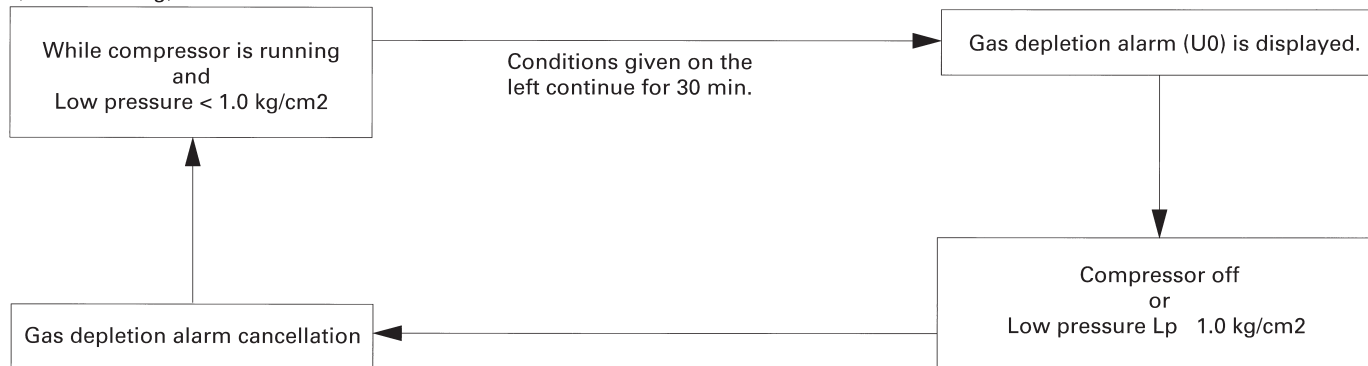

(When heating)

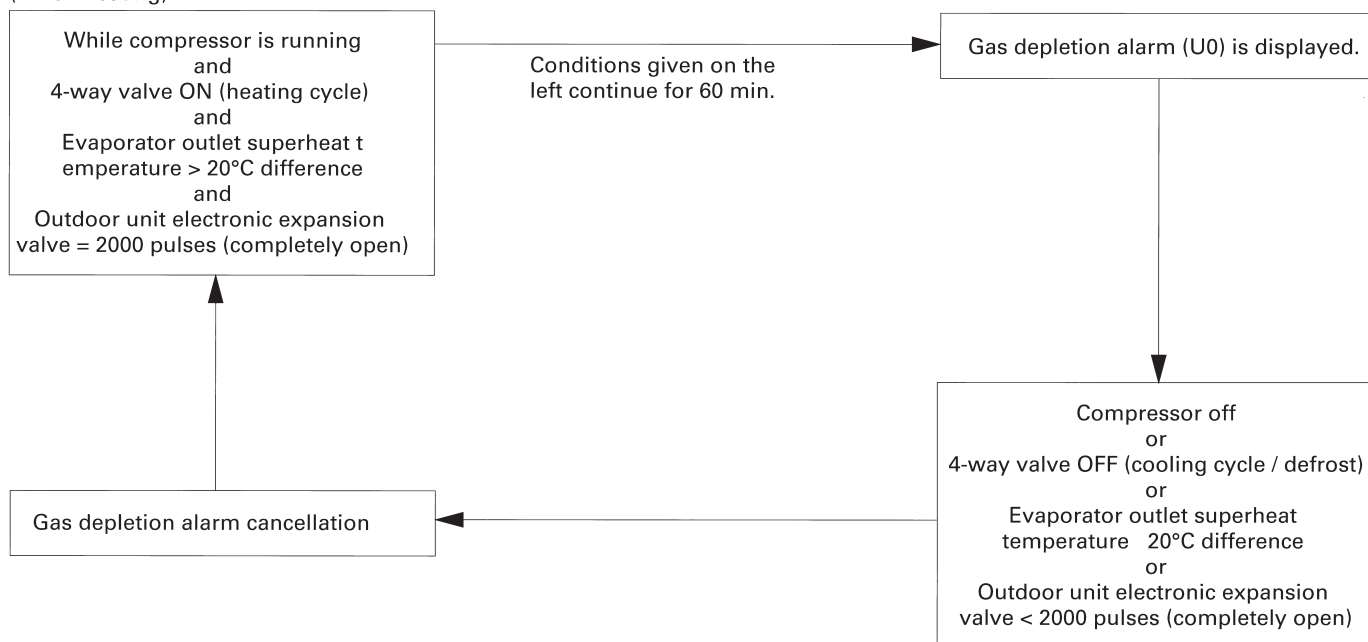

16. Drain Pump Control

1. The drain pump is controlled by the ON/OFF buttons (4 button (1) - (4) given in the figure below).

(1) When the float switch is tripped while the cooling thermostat is ON:

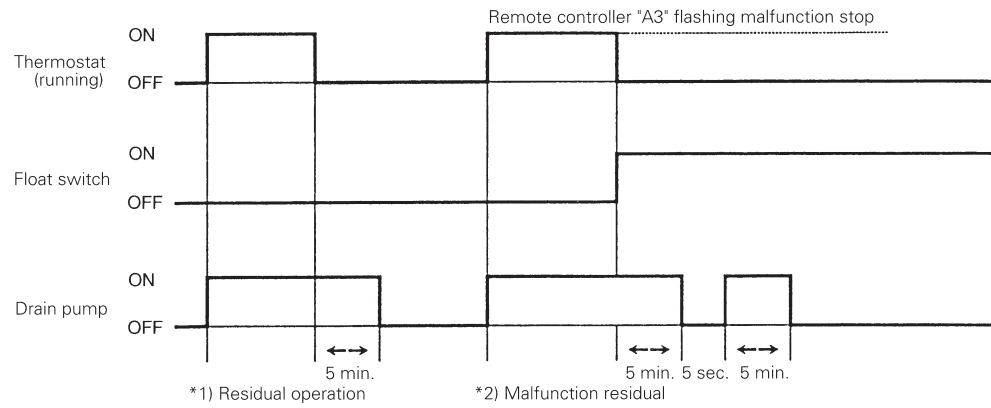

- ※1. The objective of residual operation is to completely drain any moisture adhering to the fin of the indoor unit heat exchanger when the thermostat goes off during cooling operation.
- ※2. One cycle consists of 5 minutes of operation, 5 seconds stop, and another 5 minutes of operation.

(2) When the float switch is tripped during cooling OFF by thermostat:

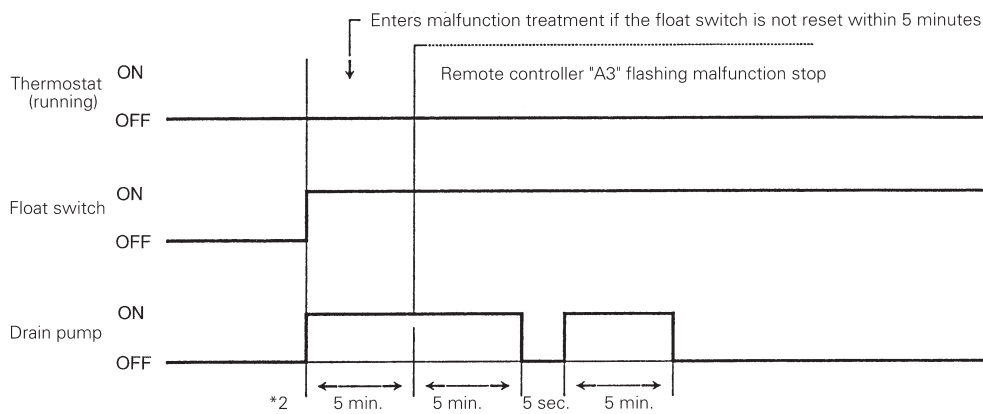

(3) When the float switch is tripped during heating operation:

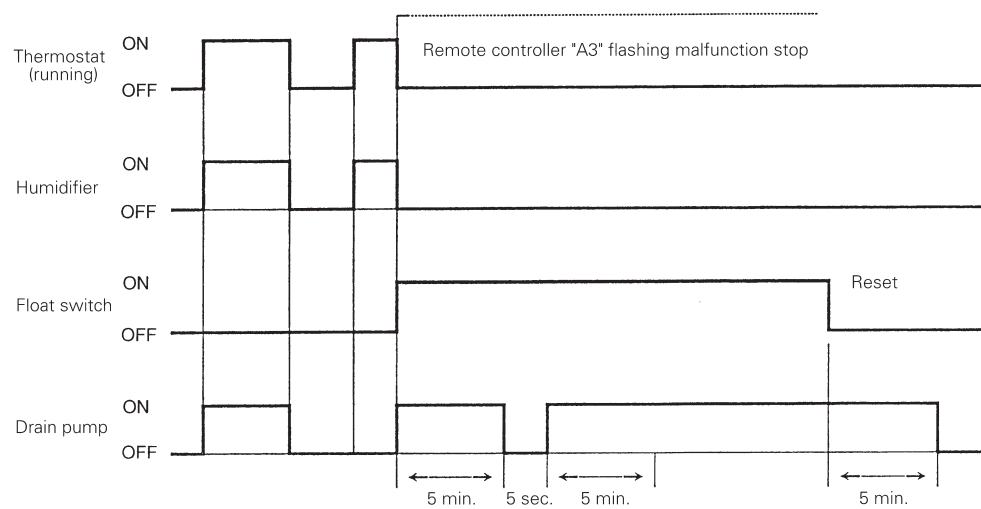

During heating operation, if the float switch is not reset even after the 5 minutes operation, 5 seconds stop, 5 minutes operation cycle ends, operation continues until the switch is reset.



(4) When the float switch is tripped and "AF" is displayed on the remote controller:

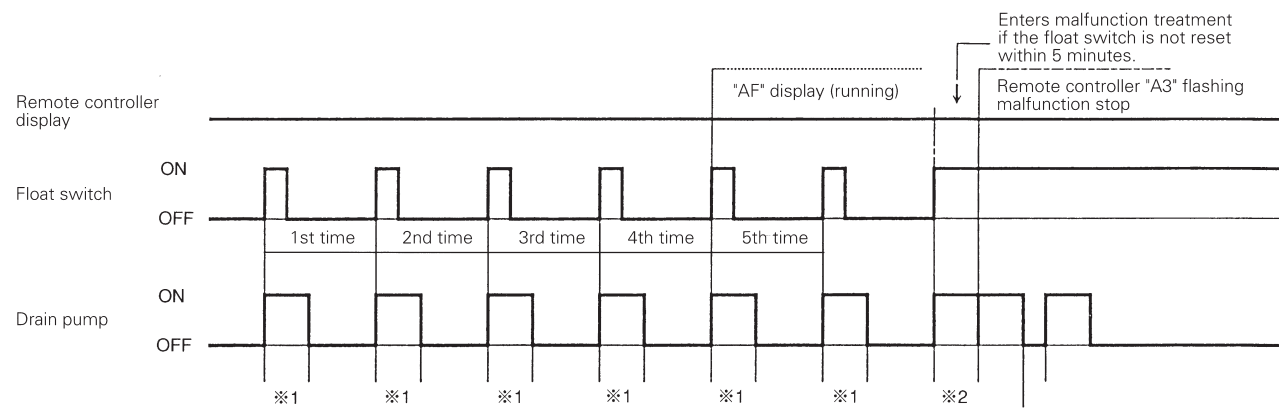

Note: If the float switch is tripped five times in succession, a drain malfunction is determined to have occurred. "AF" is then displayed as operation continues.



17. Oil Temperature Sensor (8 and 10 Hp only)

(1) Prevention of wetness during heating

- Wet operation is prevented by modification of super heating (SH) by oil temperature sensor (R5T). (Low equivalent pressure = T_e)

$R5T \leq T_e + 10^\circ\text{C}$ → SH = 10°C

$R5T > T_e + 10^\circ\text{C}$ → SH = 5°C

(2) Prevention of oil dilution during defrost

- The unit controls upper limit frequency of the compressor and is designed to prevent oil from being diluted while defrosting by means of an oil temperature sensor.

$R5T \leq T_e + 10^\circ\text{C}$ → INV · 86Hz+STD · ON

$R5T > T_e + 10^\circ\text{C}$ → INV · 116Hz+STD · ON

- Startup subsequent to defrosting is improved by the oil temperature sensor.

$R5T \leq T_e + 10^\circ\text{C}$ → INV · 116Hz+STD · OFF (20 min.)

$R5T > T_e + 10^\circ\text{C}$ → Upper limit release



18. Louver Control for Preventing Ceiling Dirt

We have added a control feature that allows you to select the range of in which air direction can be adjusted in order to prevent the ceiling surrounding the air discharge outlet of ceiling mounted cassette type units from being soiled. (This feature is available on double flow, multiflow and corner types.)

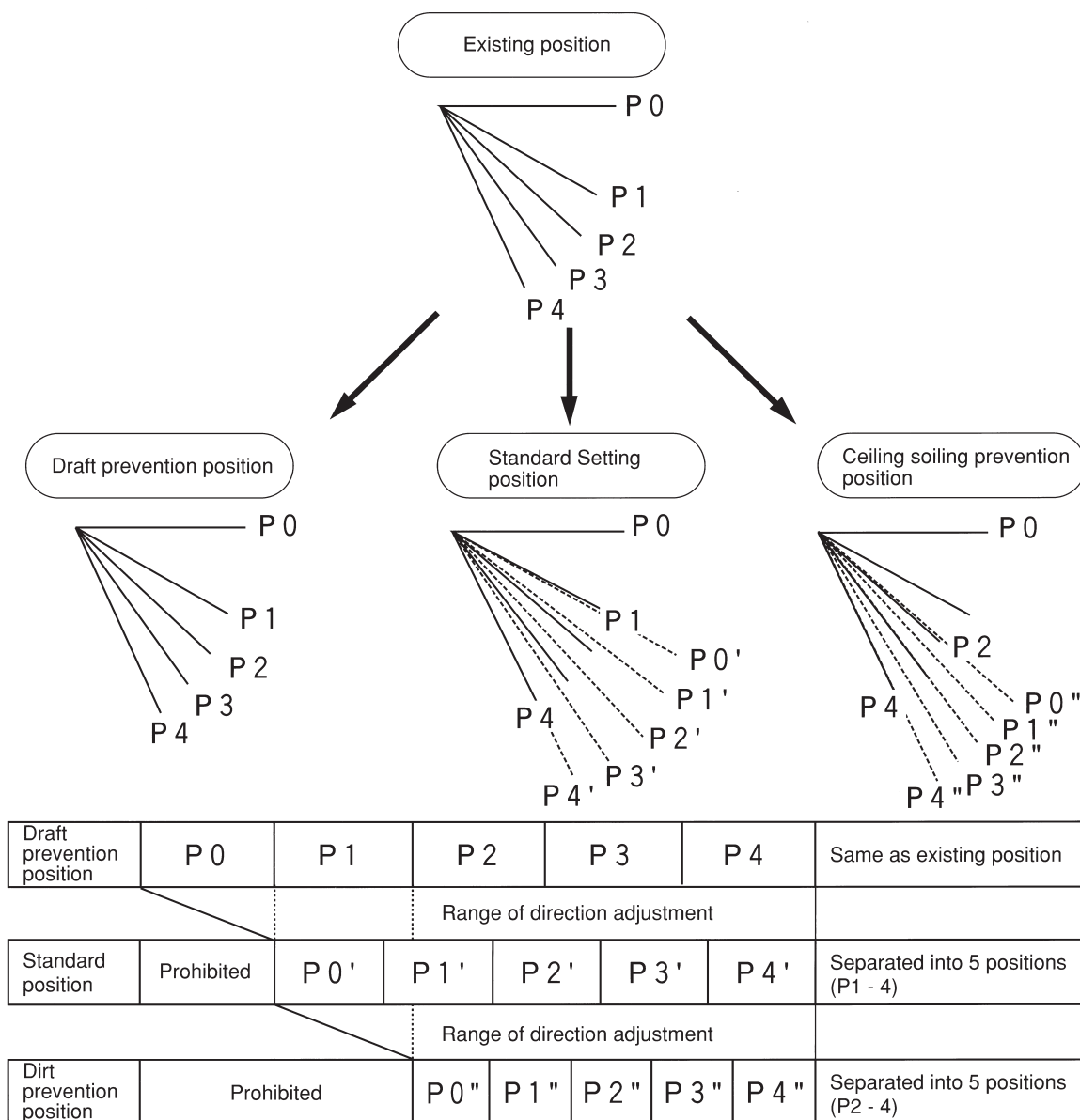

The factory set position is standard position.



19. Thermostat Sensor in Remote Controller

Temperature is controlled by both the thermostat sensor in remote controller and air suction thermostat in the indoor unit. (This is however limited to when the field setting for the thermostat sensor in remote controller is set to "Use.")

(Cooling)

If there is a significant difference in the preset temperature and the suction temperature, fine adjustment control is carried out using a body thermostat sensor, or using the sensor in the remote controller near the position of the user when the suction temperature is near the preset temperature.

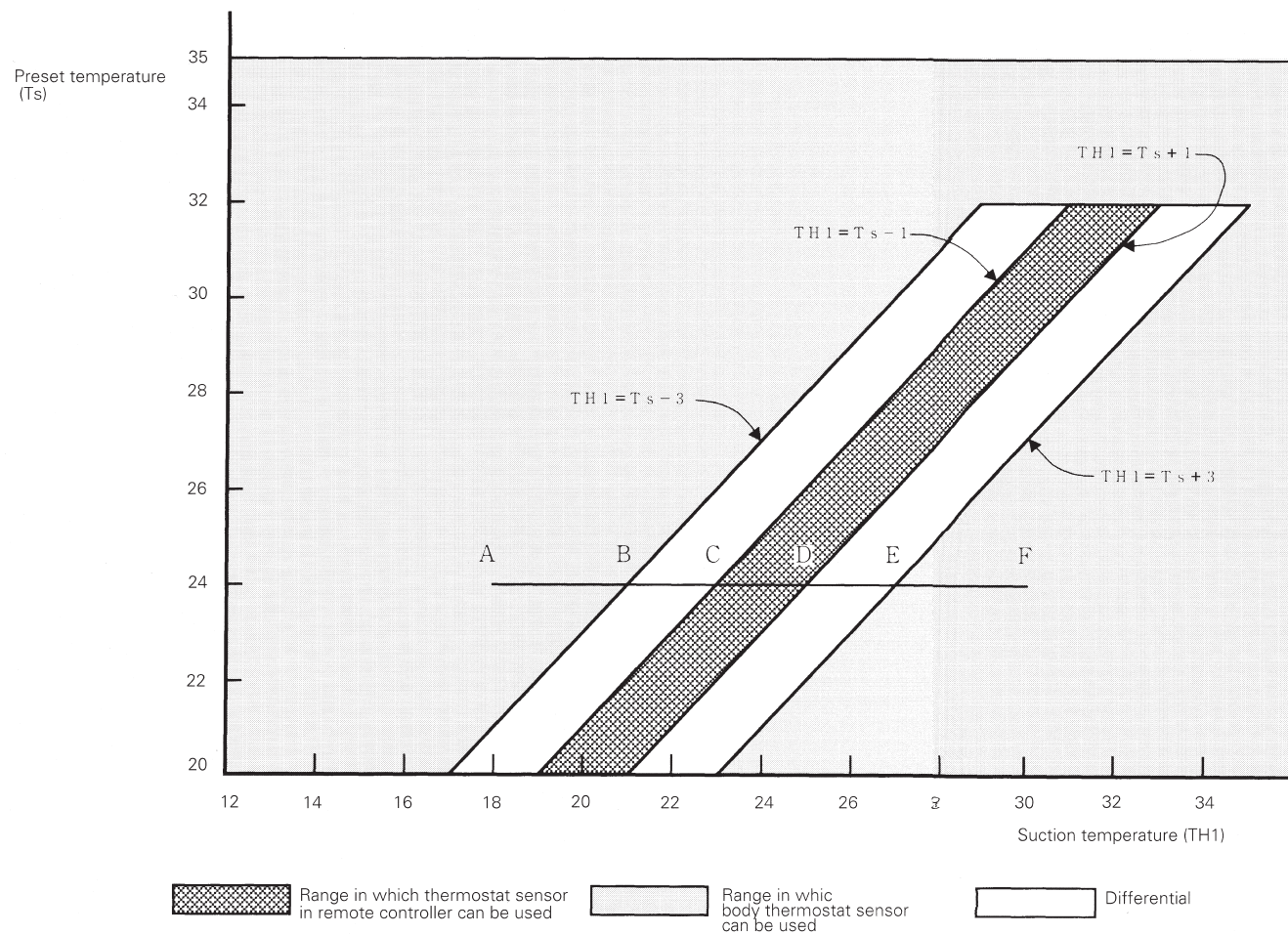

(Ex: When cooling)

Assuming the preset temperature in the figure above is 24°C, and the suction temperature has changed from 18°C to 30°C (A → F): (This example also assumes there are several other air conditioners, the VRV system is off, and that temperature changes even when the thermostat sensor is off.)

- Body thermostat sensor is used for temperatures from 18°C to 23°C (A → C).
- Remote controller thermostat sensor is used for temperatures from 23°C to 27°C (C → E).
- Body thermostat sensor is used for temperatures from 27°C to 30°C (E → F).

And, assuming suction temperature has changed from 30°C to 18°C (F → A):

- Body thermostat sensor is used for temperatures from 30°C to 25°C (F → D).
- Remote controller thermostat sensor is used for temperatures from 25°C to 21°C (D → B).
- Body thermostat sensor is used for temperatures from 21°C to 18°C (B → A).



(Heating)

When heating, the hot air rises to the top of the room, resulting in the temperature being lower near the floor where the occupants are. When controlling by body thermostat sensor only, the unit may therefore be turned off by the thermostat before the lower part of the room reaches the preset temperature. The temperature can be controlled so the lower part of the room where the occupants are doesn't become cold by widening the range in which thermostat sensor in remote controller can be used so that suction temperature is higher than the preset temperature.

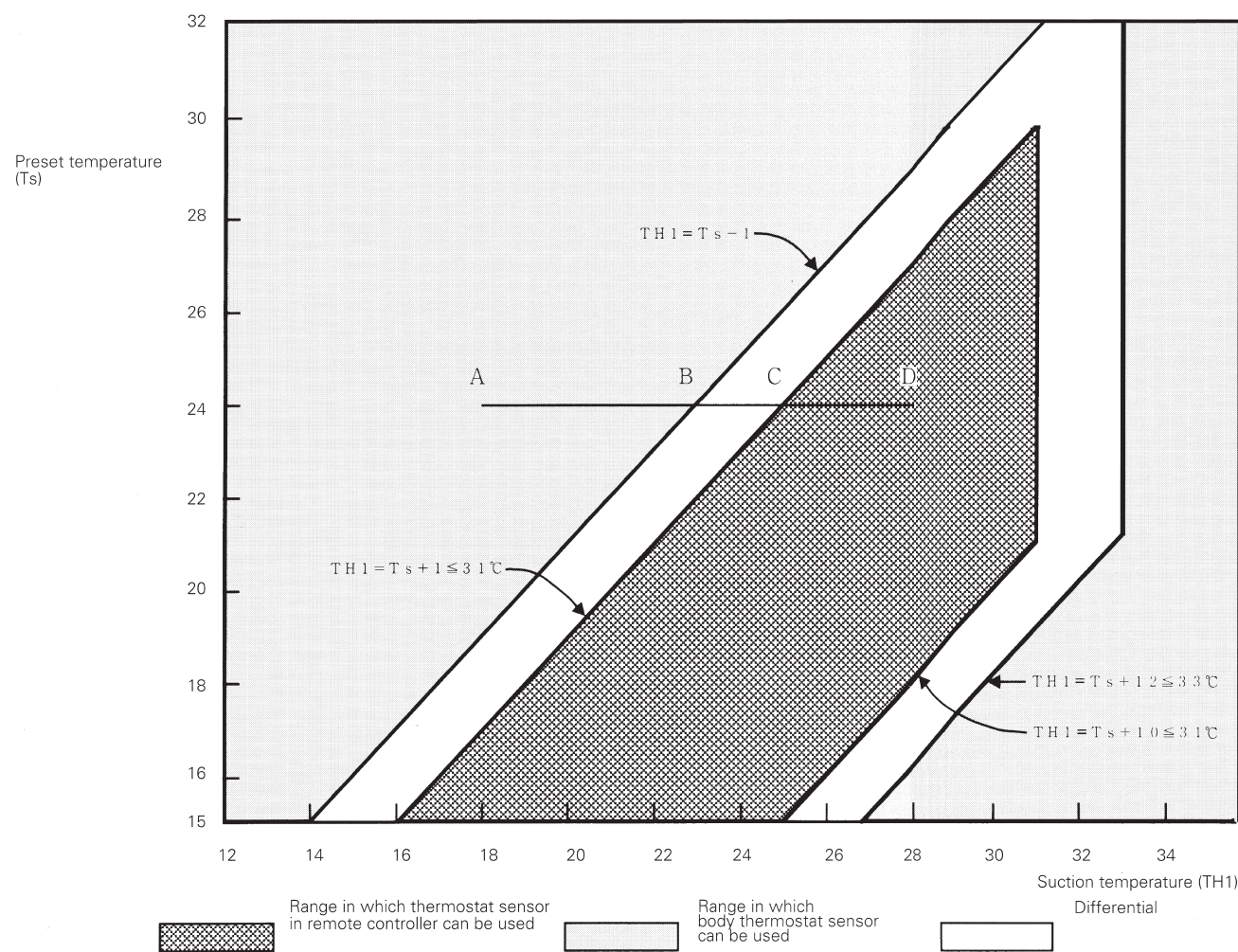

(Ex: When heating)

Assuming the preset temperature in the figure above is 24°C, and the suction temperature has changed from 18°C to 28°C (A → F):
(This example also assumes there are several other air conditioners, the VRV system is off, and that temperature changes even when the thermostat sensor is off.)

Body thermostat sensor is used for temperatures from 18°C to 25°C (A → C).

Remote controller thermostat sensor is used for temperatures from 25°C to 28°C (C → E).

And, assuming suction temperature has changed from 28°C to 18°C (D → A):

Remote controller thermostat sensor is used for temperatures from 28°C to 23°C (D → B).

Body thermostat sensor is used for temperatures from 23°C to 18°C (B → A).



20. Freeze Prevention

Freeze prevention by off cycle (indoor unit)

When the temperature detected by liquid pipe temperature thermistor (R2T) of the indoor unit heat exchanger drops too low, the unit enters freeze prevention operation in accordance with the following conditions, and is also set in accordance with the conditions given below.

Conditions for starting freeze prevention: Temperature is -1°C or less for total of 40 min., or temperature is -5°C or less for total of 10 min.

Conditions for stopping freeze prevention: Temperature is $+7^{\circ}\text{C}$ or more for 10 min. continuously

Ex: Case where temperature is -5°C or less for total of 10 min.

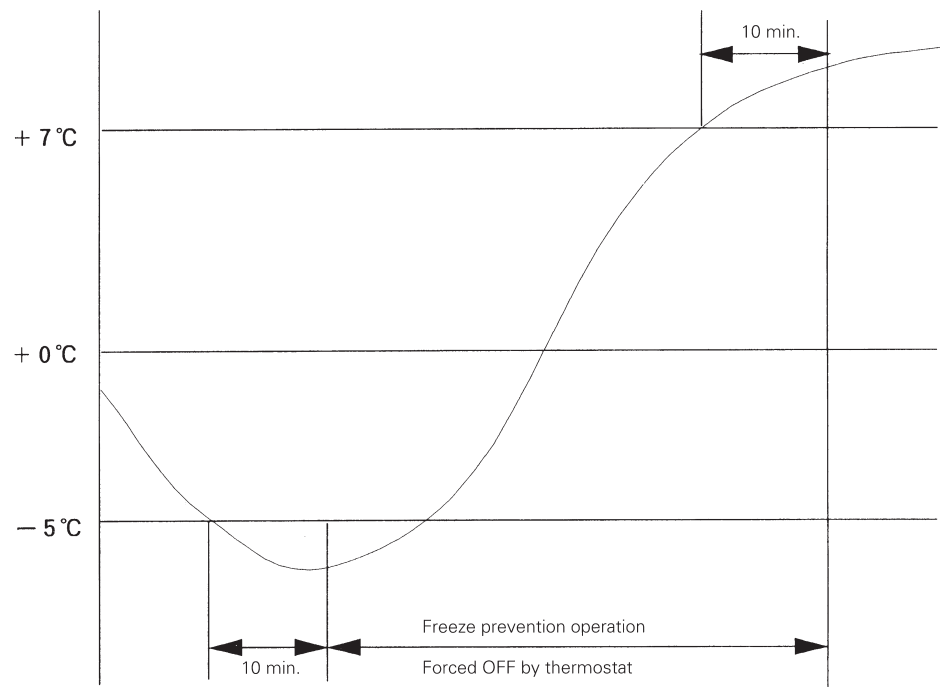



TEST OPERATION

Inverter K series



Все каталоги и инструкции здесь: <https://splitssystema48.ru/instrukcii-po-ekspluatatsii-kondicionerov.html>





1. When Power is Turned On

■ When turning power on the first time

The unit will not run for up to 12 minutes in order for master power supply and address (indoor unit address, etc.) to be set automatically.

Outdoor unit	Warning lamp (HWL)..... On Test lamp (H2P) Flicker Can be set while in operation.
--------------	---

Indoor unit	"UH" malfunction code flickers when the ON/OFF button is pushed during the aforementioned operation. (Returns to normal when automatic setting is complete.)
-------------	---

■ When turning power on after the first time

※ Tap the RESET button on the outdoor unit PC Board. The unit can be operated after setting up for about two minutes.

If the RESET button is not pushed, the unit will not run for up to 10 minutes in order for master power supply to be set automatically.

Outdoor unit	HWL lamp..... On Test lamp (H2P) Flicker Can be set while in operation.
--------------	---

Indoor unit	If the ON/OFF button is pushed during the aforementioned operation, the operation lamp lights but the unit will not run. (Returns to normal when automatic setting is complete.)
-------------	---

■ If outdoor, indoor or BS unit is extended, or if indoor/outdoor unit PC board is replaced:

In these cases, be sure to push and hold the RESET button for 5 seconds or more. The system will not recognize the extension if this operation is not performed. The unit will not run for up to 12 minutes in order for the addresses (indoor unit address, etc.) to be set automatically.

Outdoor unit	Warning lamp (HWL)..... On Test lamp (H2P) Flicker Can be set while in operation.
--------------	---

Indoor unit	"UF" or "U4" malfunction code flickers when the ON/OFF button is pushed during the aforementioned operation. (Returns to normal when automatic setting is complete.)
-------------	---

2. Outdoor Unit PC Board Ass'y

RSXY8K
10K

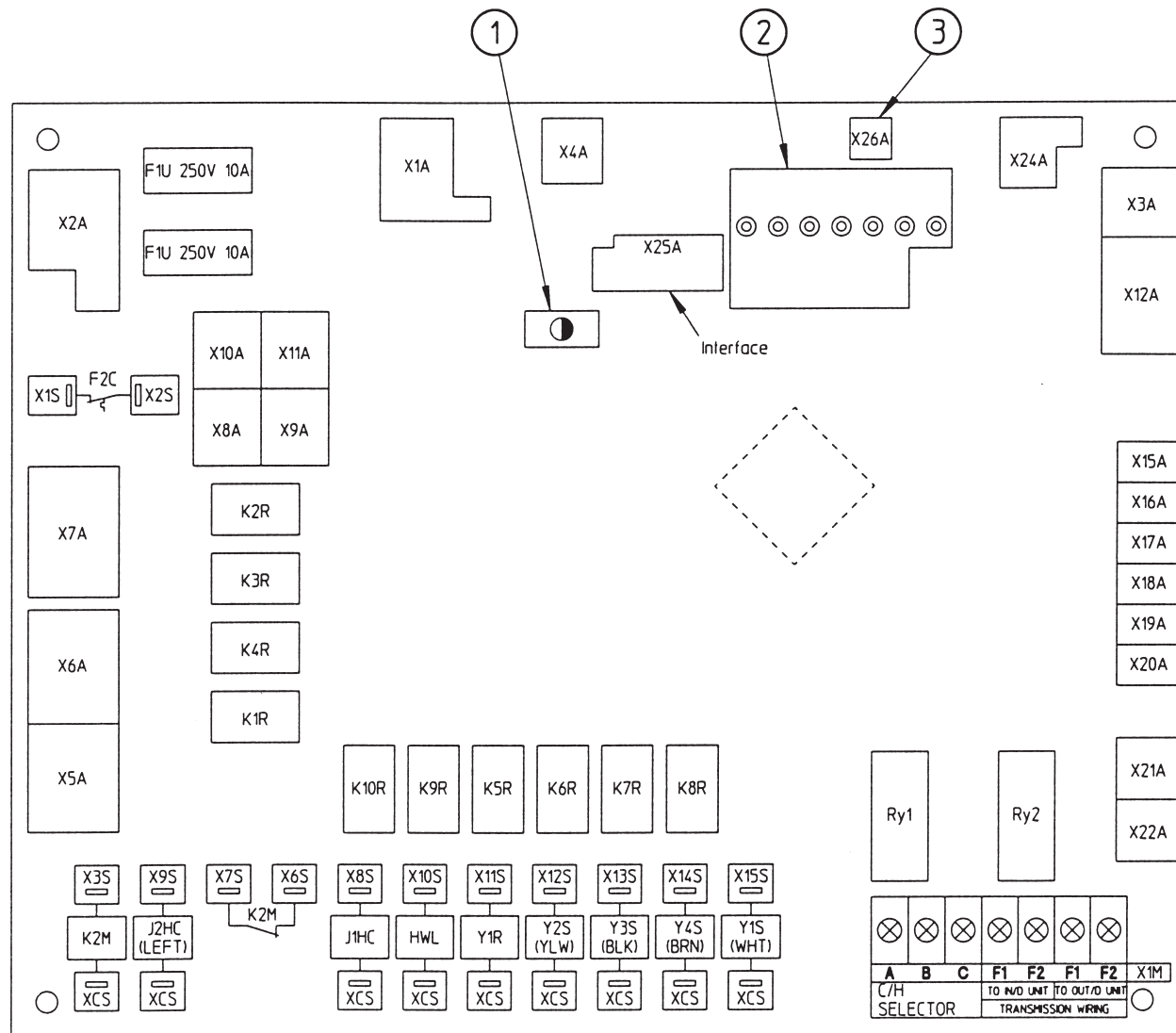

①	<p>Service monitor <HAP> (Green)</p> <p>NormalFlicker MalfunctionOn or off</p>
②	<p>Function setting switch or LED</p> <p>LED display ○ : On ● : Flicker ● : Off</p> <p>Mode buttonMode change</p> <p>Setting mode 1 (H1P off) → Push 1 time. → Monitor mode (H1P flickers) → Push 1 time. Setting mode 1 (H1P off) → Push and hold for 5 sec. → Setting mode 2 (H1P on) → Push 1 time.</p> <ul style="list-style-type: none"> • Set return buttonChanges or enters address or data. • Wiring check button ...Push and hold for 5 sec. to start wiring check. • Reset buttonPush and hold for 5 sec. if the indoor unit's PC board has been replaced, or there has been a change in the combination of indoor and outdoor units, such as indoor unit extension, etc.
③	<p>Jumper pin</p> <p>Interlock overcurrent compressor 2</p>

Все каталоги и инструкции здесь: <https://splitssystema48.ru/instrukcii-po-ekspluatatsii-kondicionerov.html>

3. Setting Modes

The three setting modes are as follows:

- **Setting mode 1**Mode for selecting cool/heat setting method, and whether or not to use low noise operation and sequential start.
(H1P off)
- **Setting mode 2**Mode for changing operating status and setting addresses; used primarily for service.
(H1P on)
- **Monitor mode**Mode for checking setting made in the setting modes, number of connected units, etc.
(H1P flickers)

The flow of the setting modes is as follows. (See the following pages for details.)

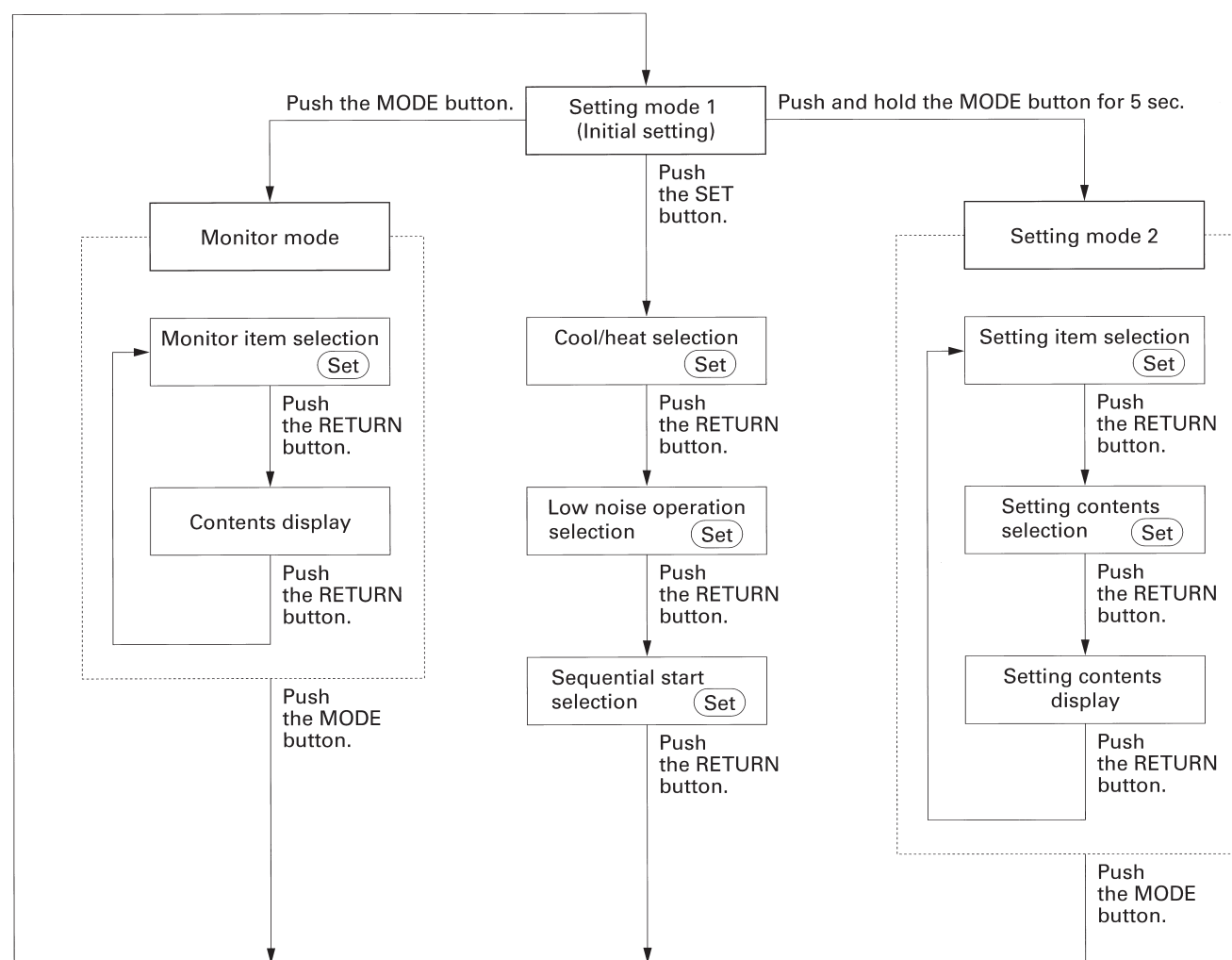

- You can make your selections with the SET button. (Set)

If you become unsure of how to proceed, push the MODE button and return to setting mode 1.

☆ You don't have to perform power supply reset after changing settings in setting mode 1 (including [SS1] cool/heat selection switch on the outdoor unit PC board) and setting mode 2.

(1) Setting Mode 1

Cool/heat selection setting (SS1) If carried out from the indoor unit remote controller: If carried out from the cool/heat selector:



MODE	TEST	C/H SELECT			L.N.O.P.	SEQ. START
		IND	MASTER	SLAVE		
H1P	H2P	<input type="radio"/>	<input checked="" type="radio"/>	<input checked="" type="radio"/>	<input checked="" type="radio"/>	<input type="radio"/>

The factory settings are:
Individual (C/H SELECT), OFF (L.N.O.P.), ON (SEQ. START)

You can change the cool/heat selection permission, low noise and sequential start settings by pushing the SET switch.

To skip settings you don't want to change, push the RETURN switch and go to the next setting.

SET

Change cool/heat selection to MASTER.

An optional adaptor for outside control of outdoor units is required if you have set cool/heat selection to MASTER or SLAVE.

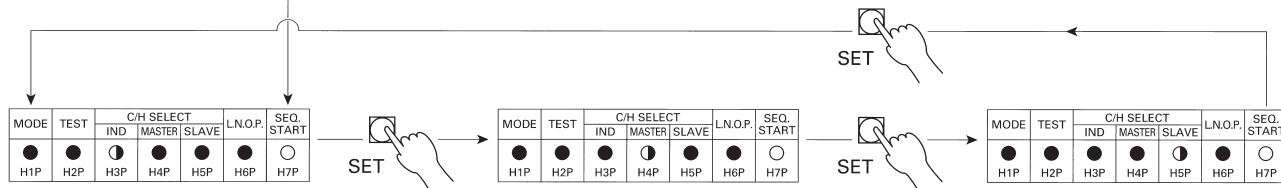

Change low noise operation to "ON".
External control adaptor for outdoor unit is required if low noise operation is set to "ON".

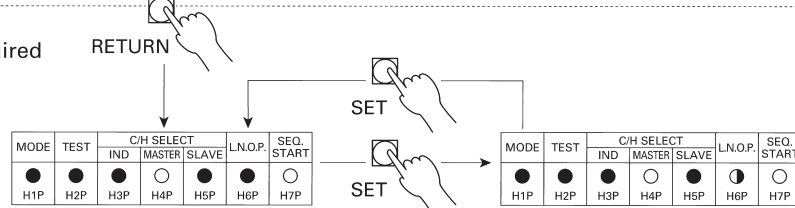

Change sequential start to "OFF".

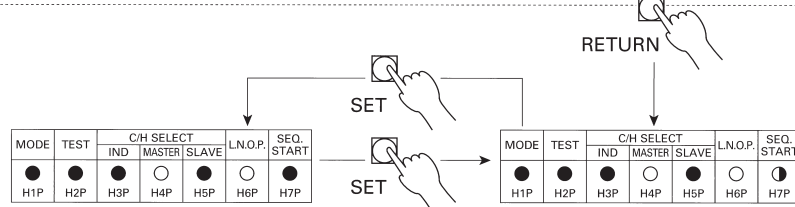

Setting complete
GROUP MASTER (cool/heat selection),
ON (low noise), OFF (sequential start)

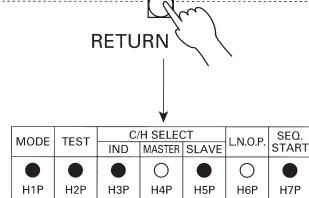

MODE

Monitor mode

MODE

Setting mode 2

Push and hold for 5 sec.

- NOTE: 1. RSXY5K is completed by low noise setting.
2. External control adaptor for outdoor unit is required if cool/heat selection set to MASTER or SLAVE, or if low noise operation is set to ON. For further information, see page 47.

(2) Setting Mode 2

To enter setting mode 2 from setting mode 1 (normal), you must push and hold the MODE button (BS1) for 5 seconds. (Setting mode 2 cannot be entered while still making settings in setting mode 1.)

Setting procedure

- ① Push the SET button and match with the setting item (LED display). (All 10 settings)
- ↓
- ② Push the RETURN button (BS3) and the present settings flicker (LED display).
- ↓
- ③ Push the SET button (BS2) and match with each setting (LED flicker display).
- ↓
- ④ Push the RETURN button (BS3) and enter the settings.
- ↓
- ⑤ Push the RETURN button (BS3) and return to the initial status.

Note: ● If you become unsure of how to proceed, push the MODE button (BS1) and return to setting mode 1.

● The initial status of setting mode 2 is the status of setting item No. 1 in mode 2.

☆1 ...Cannot be set with RSXY5K.

Settings

Setting item	Description	LED display							LED display													
		H1P	H2P	H3P	H4P	H5P	H6P	H7P	H1P	H2P	H3P	H4P	H5P	H6P	H7P							
1 EMG ☆1	Emergency operation when malfunction occurs	○	●	●	●	●	●	●	Emergency operation (Runs only by standard compressor)	○	●	●	●	○	●	Normal operation	○	●	●	●	●	○
2 Cool/heat group address	Address for cool/heat group operation	○	●	●	●	●	○	○	Address 0	○	●	●	●	●	○	Binary number 1	○	●	●	●	○	○
									Binary number 2	○	●	●	●	○	Binary number 3	○	●	●	○	○	○	
									Binary number 31	○	○	○	○	○	Binary number 30	○	○	○	○	○	○	
3 Low noise / demand address	Address for low noise / demand group operation	○	●	●	●	○	○	○	Address 0	○	●	●	●	○	Binary number 1	○	●	●	○	○	○	
									Binary number 2	○	●	●	○	○	Binary number 3	○	●	○	○	○	○	
									Binary number 31	○	○	○	○	○	Binary number 30	○	○	○	○	○	○	
4 Forced fan switch	Fan of stopped indoor unit turns	○	●	●	○	○	○	○	Forced fan operation (H tap)	○	●	●	○	○	Normal operation	○	●	●	○	○	○	
5 Indoor unit forced operation	Allows operation of indoor unit from outdoor unit	○	●	●	○	○	○	○	Indoor unit forced operation	○	●	●	○	○	Normal operation	○	●	●	○	○	○	
6 Frequency fix	Fixes the frequency of the inverter compressor 5HP~68Hz 8.10HP~86Hz+ON	○	●	●	○	○	○	○	Frequency fix	○	●	●	○	○	Normal operation	○	●	●	○	○	○	
7 Te setting	Low pressure setting for cooling	○	●	○	○	○	○	○	High	○	●	○	○	○	Normal (factory set)	○	●	○	○	○	○	
8 Tc setting	High pressure setting for heating	○	●	○	○	○	○	○	Low	○	●	○	○	○		○	●	○	○	○	○	
9 Defrost setting	Temperature setting for defrost	○	●	○	○	○	○	○	Quick defrost	○	●	○	○	○	Normal (factory set)	○	●	○	○	○	○	
									Slow defrost	○	●	○	○	○		○	●	○	○	○	○	
10 Not used	Airnet address	○	●	○	○	○	○	○	Address 0	○	●	○	○	○	Binary number 1	○	●	○	○	○	○	
									Binary number 2	○	●	○	○	○	Binary number 3	○	●	○	○	○	○	
									Binary number 63	○	○	○	○	○	Binary number 62	○	○	○	○	○	○	

Note: Additional refrigerant charge and refrigerant recovery function are also possible for R-22 K-series. For further details we refer to the R-407C K-series service manual.

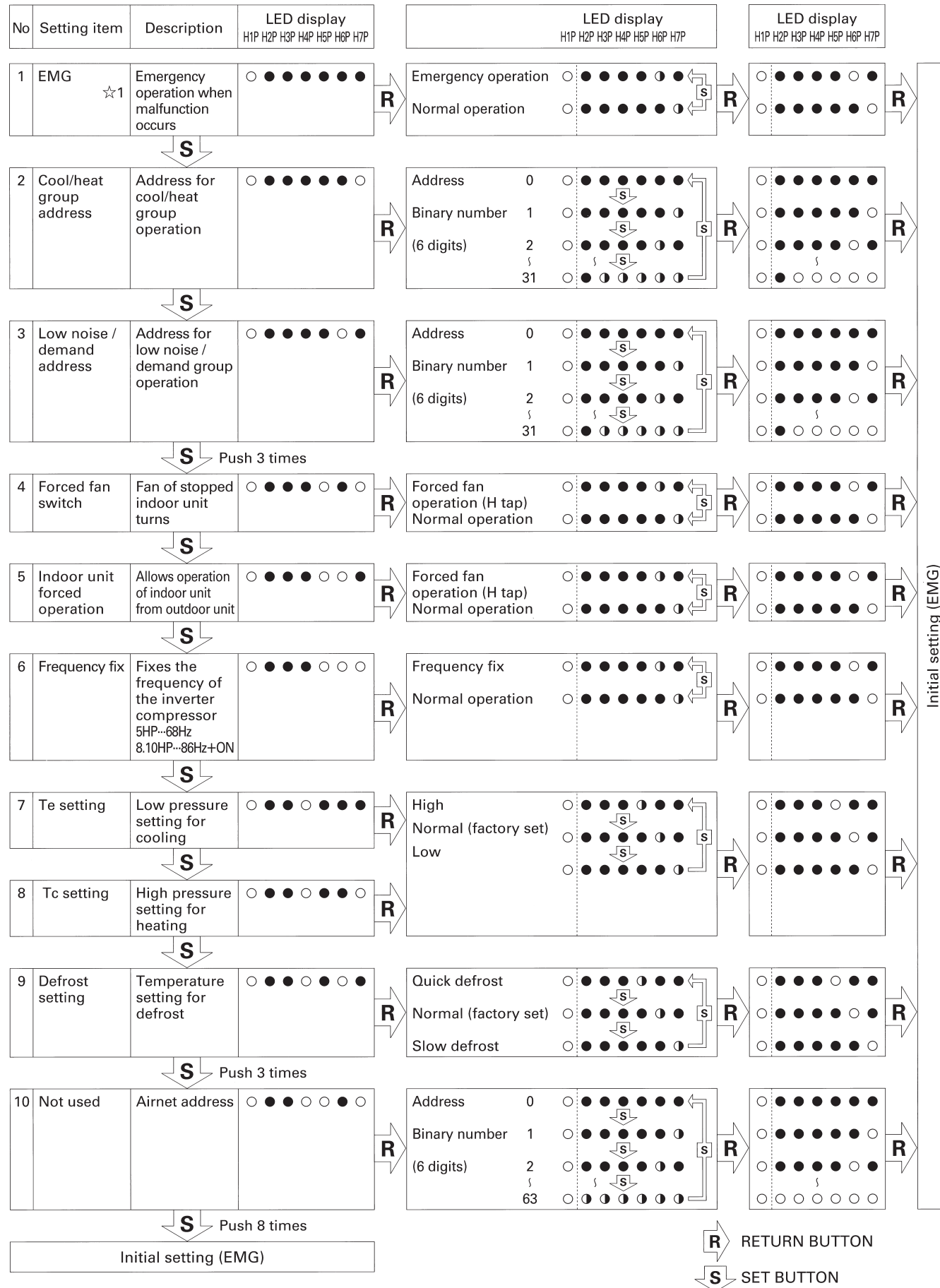

(3) Monitor Mode

MODE	TEST	C/H SELECT			L.N.O.P.	SEQ. START
		IND	MASTER	SLAVE		
<input checked="" type="radio"/> H1P	<input checked="" type="radio"/> H2P	<input type="radio"/> H3P	<input checked="" type="radio"/> H4P	<input checked="" type="radio"/> H5P	<input checked="" type="radio"/> H6P	<input type="radio"/> H7P

To enter the monitor mode, push the MODE button when in setting mode 1.

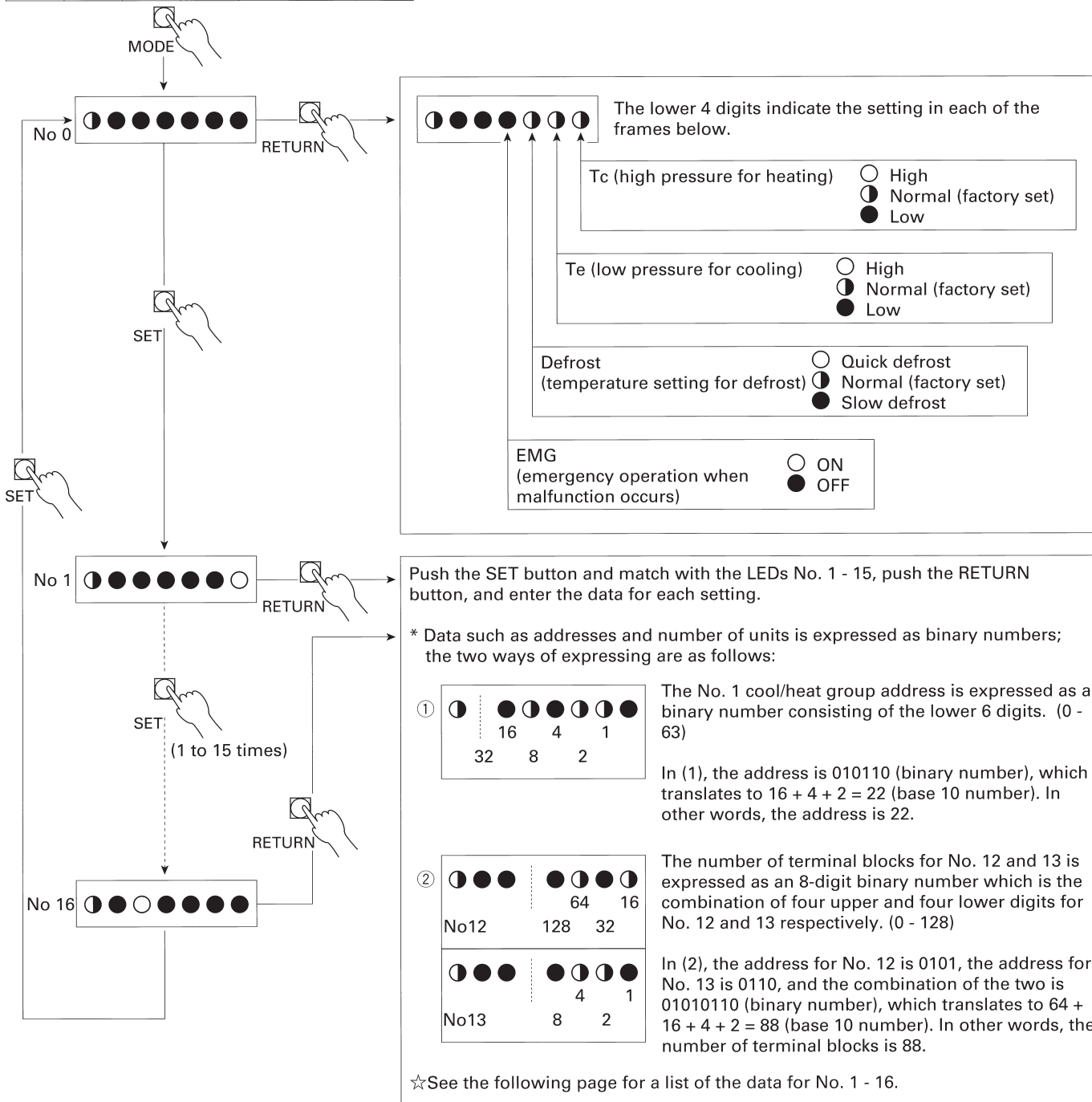

☆After making sure the data is correct, push the RETURN button and return to No. 0, or push the MODE button and return to setting mode 1.



• Monitor Mode Data

Mode No.	LED	Data	Display method	Size (binary number)
No 1	● ● ● ● ● ● ○	Cool/heat group address	0 ~ 31	Lower 6 digits
No 2	● ● ● ● ● ○ ●	Low noise / demand address	0 ~ 31	Lower 6 digits
No 3	● ● ● ● ● ○ ○	Not used		
No 4	● ● ● ● ○ ● ●	Not used	0 ~ 63	Lower 6 digits
No 5	● ● ● ● ○ ● ○	Number of connected units	0 ~ 63 units	Lower 6 digits
No 6	● ● ● ● ○ ○ ●	Number of connected BS units	0 ~ 63 units	Lower 6 digits
No 7	● ● ● ● ○ ○ ○	Number of connected zone units (excluding outdoor and BS units)	0 ~ 63 units	Lower 6 digits
No 8	● ● ● ○ ● ● ●	Number of outdoor units	0 ~ 63 units	Lower 6 digits
No 9	● ● ● ○ ● ● ○	Number of BS units	0 ~ 128 units	Lower 4 digits, upper
No 10	● ● ● ○ ● ○ ●	Number of BS units	0 ~ 128 units	Lower 4 digits, lower
No 11	● ● ● ○ ● ○ ○	Number of zone units (excluding outdoor and BS units)	0 ~ 63 units	Lower 6 digits
No 12	● ● ● ○ ○ ● ●	Number of terminal blocks	0 ~ 128 units	Lower 4 digits, upper
No 13	● ● ● ○ ○ ● ○	Number of terminal blocks	0 ~ 128 units	Lower 4 digits, lower
No 14	● ● ● ○ ○ ○ ●	Not used		
No 15	● ● ● ○ ○ ○ ○	Not used		
No 16	● ● ○ ● ● ● ●	Not used		



Все каталоги и инструкции здесь: <https://splitssystema48.ru/instrukcii-po-ekspluatácii-kondicionerov.html>



4. Sequential Start

Separates the start timing for standard compressors by three seconds each in order to prevent over-current when several compressors are to be started simultaneously.

Sequential start is possible for up to three units wired as a group to a single power supply. You should however connect an outdoor unit of small capacity as the third unit in the sequence.

Method of sequential start

① Power supply wiring

Must be wired as a group to the power supply.

② Wiring

Connect transmission wiring to terminals F1 and F2 (outdoor - outdoor) on the outdoor unit PC board (EC1). Switch to the monitoring mode and see if sequential start has been selected. If not, switch to setting mode 1 and select sequential start. (Sequential start is factory set to "ON.") For transmission wiring, use 0.75 - 1.25 mm² sheathed vinyl cord or double-core cable.

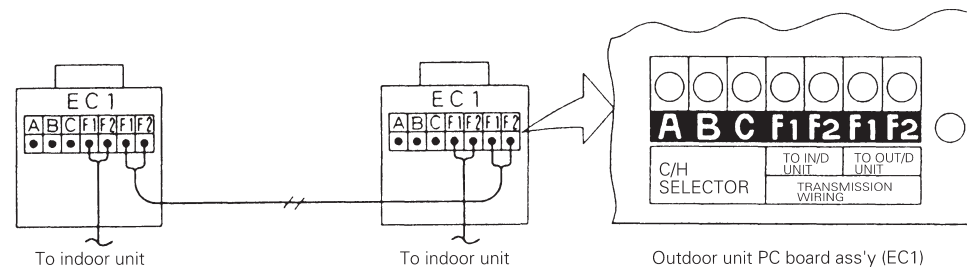

5. External Control Adaptor for Outdoor Unit

Purpose / application

External control adaptor for outdoor unit is required in order for the VRV System Inverter K Series to carry out the types of control given below.

1. Group switching of cool/heat mode for more than one outdoor unit system. The adaptor is required for cool/heat selection by indoor unit remote controller, by cool/heat selector, or by cool/heat central remote controller.
2. Low noise control
3. Demand control

Installation position

The adaptor can be installed inside any indoor unit or BS unit connected to a D III-NET.

Part names and functions

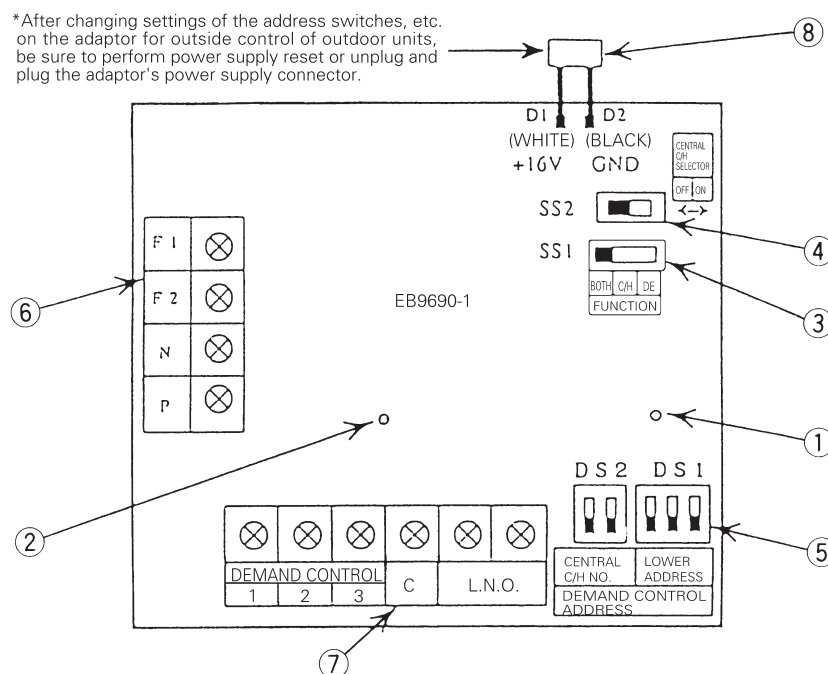

①	SERVICE MONITOR [HAP] (Green)	Normal: Flicker Malfunction: On or off	LED display ○ : On ◐ : Flicker ● : Off
②	SERVICE MONITOR [H01P] (Green)	When using cool/heat central remote controller: Normal: On Malfunction: Off (If not using cool/heat central remote controller, LED remains off.)	
③	Function switch [SS1] (Factory set: BOTH)	Sets whether the address setting switch will set cool/heat address, demand / low noise address, or both. <input type="checkbox"/> Left (BOTH) <input type="checkbox"/> Middle (C / H) <input type="checkbox"/> Right (DE-LOW NOISE)	
④	Cool/heat central remote controller selection switch [SS2] (Factory set: No)	Sets whether cool/heat central remote controller is connected or not. <input type="checkbox"/> Left (Not connected) <input type="checkbox"/> Right (Connected)	
⑤	Address setting switch [DS2 / DS1] (Factory set: 0)	Sets cool/heat address or demand address. <input type="checkbox"/> Upper 2 bits (ON) (1) <input type="checkbox"/> Lower 3 bits (OFF) (0) (The black part represents the switch.)	
⑥	Terminal block for transmission (F1 / F2) (N / P)	F1 / F2 : Wiring connection with terminals F1 and F2 of outdoor unit, etc. N / P : Wiring connection with terminals N and P of cool/heat central remote controller.	
⑦	Demand / low noise input terminal block (X1M)	Connects control input from remote source (host computer monitor panel, demand controller, timer, etc.).	
⑧	Power supply connector (D1 / D2)	Connects "power supply connector for adaptor for outside control of outdoor units" of indoor unit or BS unit, etc.	



System examples

Group selection of cool/heat mode by indoor unit remote controller

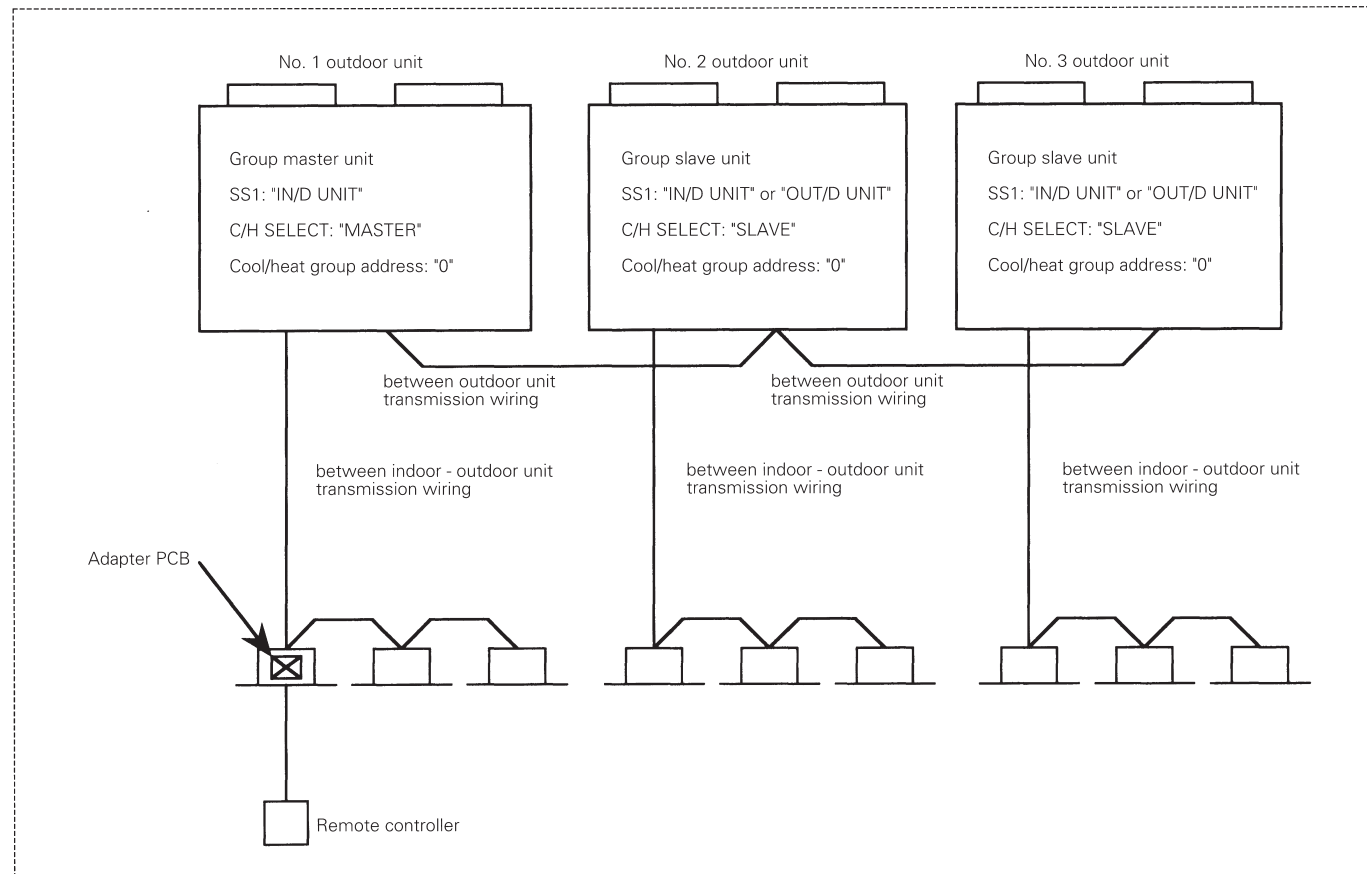

Switch settings on the adaptor PCB

• SS1

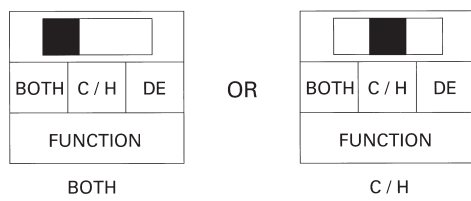

• SS2

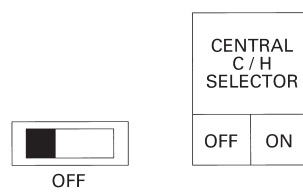

• DS1 / DS2



Outdoor unit PCB settings

• Group master unit

- SS1: "IN/D UNIT"
- Setting mode 1
- C / H SELECT : "MASTER"
- Setting mode 2
- Cool/heat group address: "0"
- Combines DS1 and DS2 of PC board adaptor.

• Group slave unit

- SS1: "IN/D UNIT" or "OUT/D UNIT"
- Setting mode 1
- C / H SELECT : "SLAVE"
- Setting mode 2
- Cool/heat group address: "0"
- Combines DS1 and DS2 of adaptor PCB.





6. Cool/Heat Mode Selection

The VRV System Inverter K Series offers the following four cool/heat mode selections.

- (1) Setting of cool/heat by individual outdoor unit system by indoor unit remote controller
- (2) Setting of cool/heat by individual outdoor unit system by cool/heat selector
- (3) Setting of cool/heat by outdoor unit system group in accordance with group master outdoor unit by indoor unit remote controller
- (4) Setting of cool/heat by outdoor unit system group in accordance with group master outdoor unit by cool/heat selector

Each of these setting methods is explained in detail below.

(For (3) and (4) be sure to perform power supply reset after changing settings.)

(1) Setting of cool/heat by individual outdoor unit system by indoor unit remote controller

- Doesn't matter whether or not there is outdoor - outdoor unit wiring.
- Set SS1 of the outdoor unit PCB to "IN / D UNIT" (factory set).
- In setting mode 1, set cool/heat selection to "IND" (factory set).

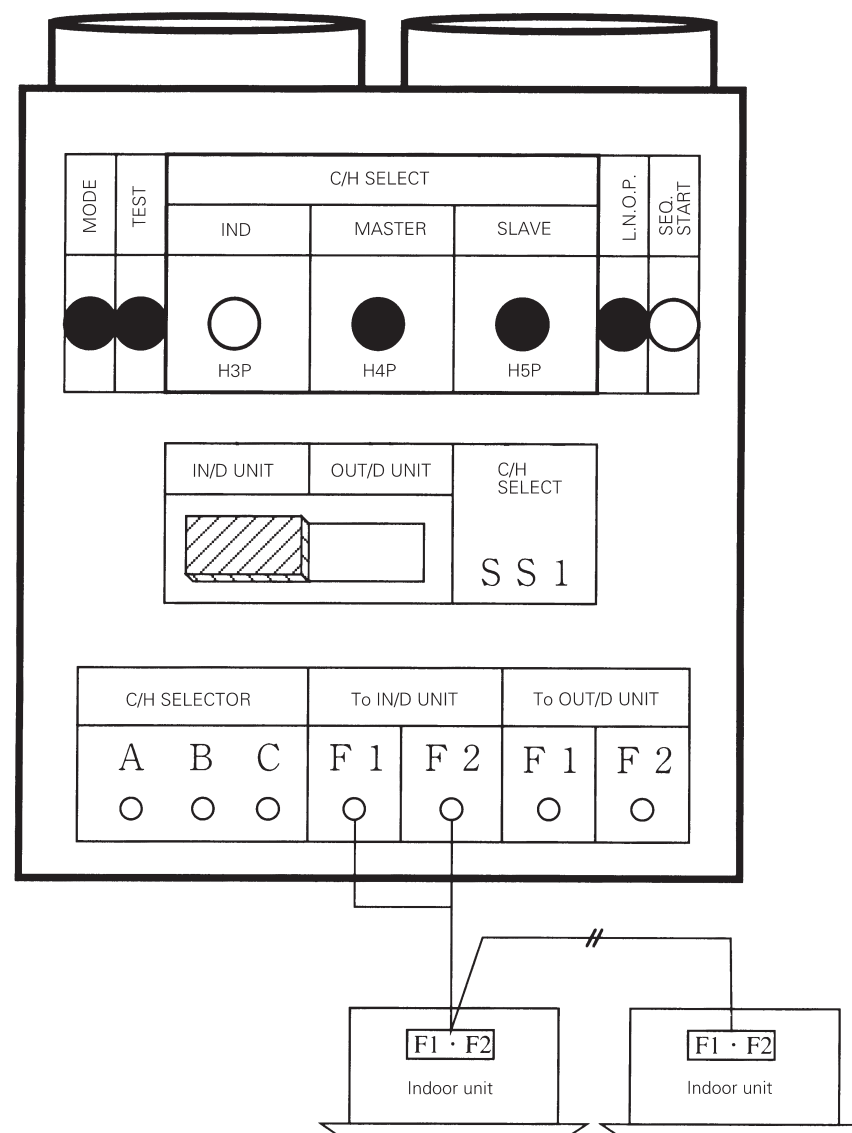

(2) Setting of cool/heat by individual outdoor unit system by cool/heat selector

- Doesn't matter whether or not there is outdoor - outdoor unit wiring.
- Set SS1 of the outdoor unit PC board to "OUT / D UNIT."
- In setting mode 1, set cool/heat selection to "IND" (factory set).

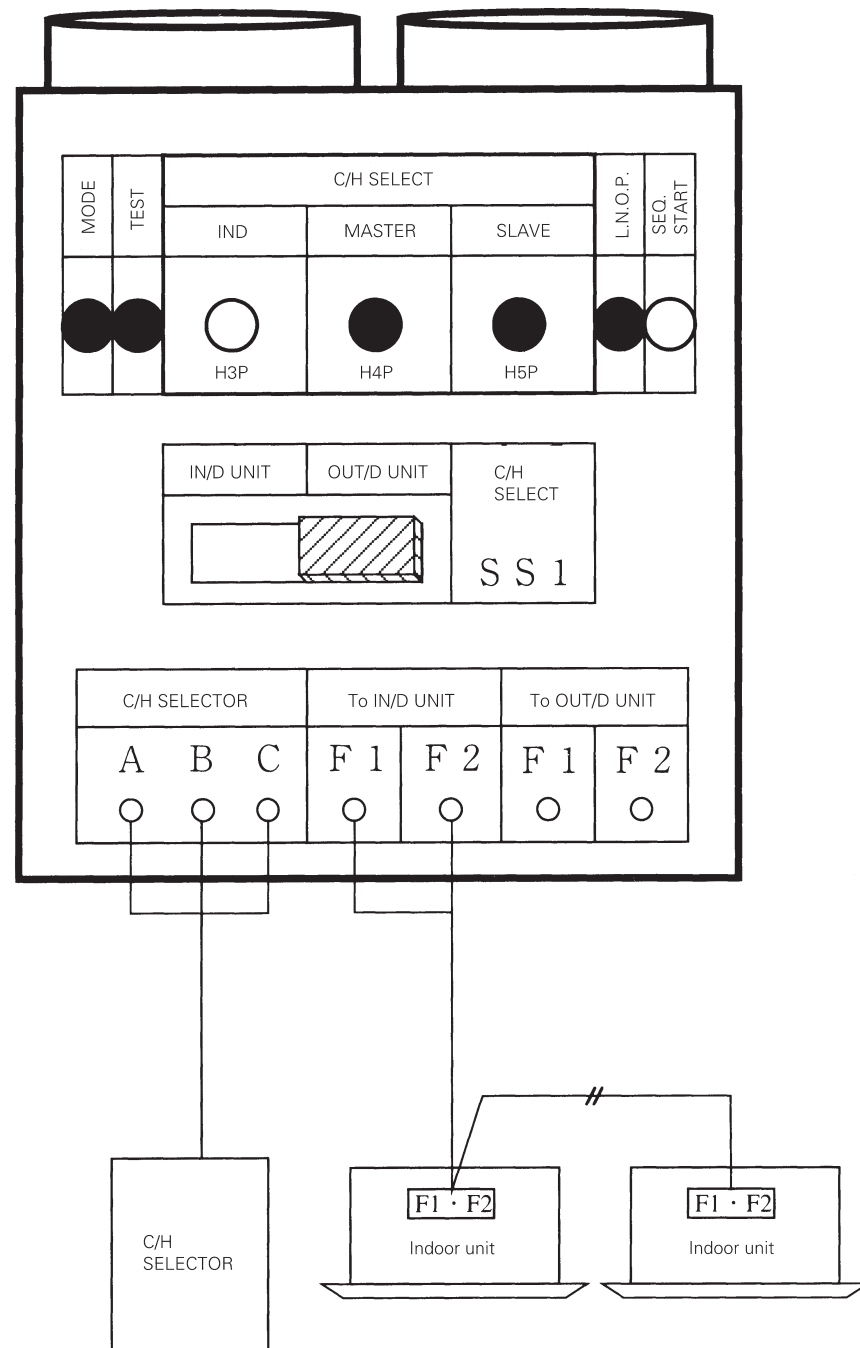

(3) Setting of cool/heat by outdoor unit system group in accordance with group master outdoor unit by indoor unit remote controller

- Install the External control adaptor for outdoor unit on either the outdoor - outdoor, indoor - outdoor, or indoor - indoor transmission line.
- Set SS1 of the outdoor unit PCB to "IN / D UNIT" (factory set).
- In setting mode 1, set the outdoor unit you want to give cool/heat selection permission to as the group master, and set the other outdoor units as group slave units.
- Set SS1 of the External control adaptor for outdoor unit to "BOTH" (factory set) or "C / H." Set SS2 to "OFF" (factory set).

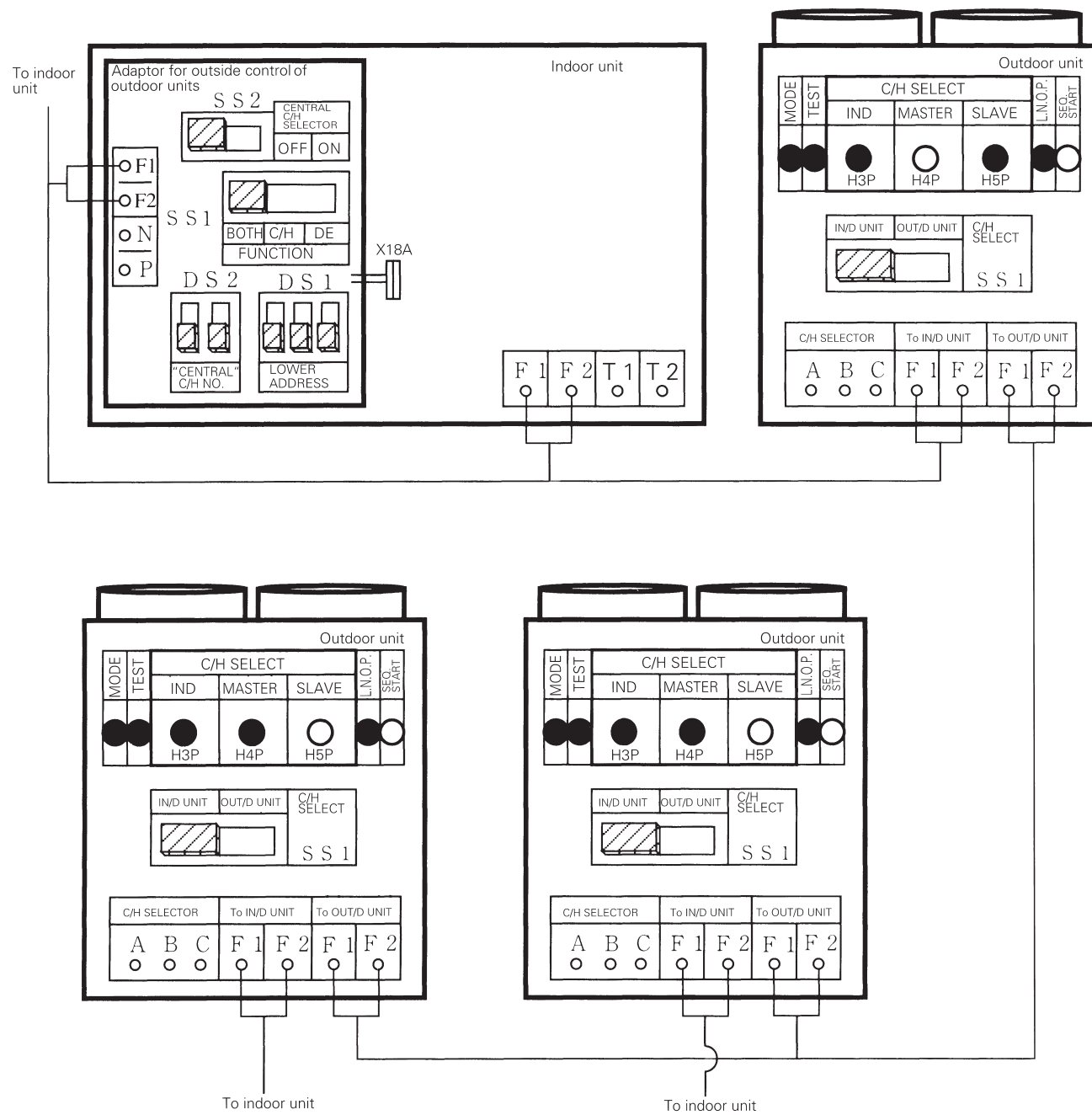

(4) Setting of cool/heat by outdoor unit system group in accordance with group master outdoor unit by cool/heat selector

- In addition to (3), change the following:
- Install a cool/heat selector to the group master outdoor unit.
- Set SS1 of the group master outdoor unit's PCB to "OUT / D UNIT."

Supplement to (3) and (4)

- If using several adaptor PCB and you want to select cool/heat mode for each adaptor PCB, set DS1 / DS2 of the adaptor PCB and the cool/heat group address on the outside unit's PCB to the same setting in setting mode 2.

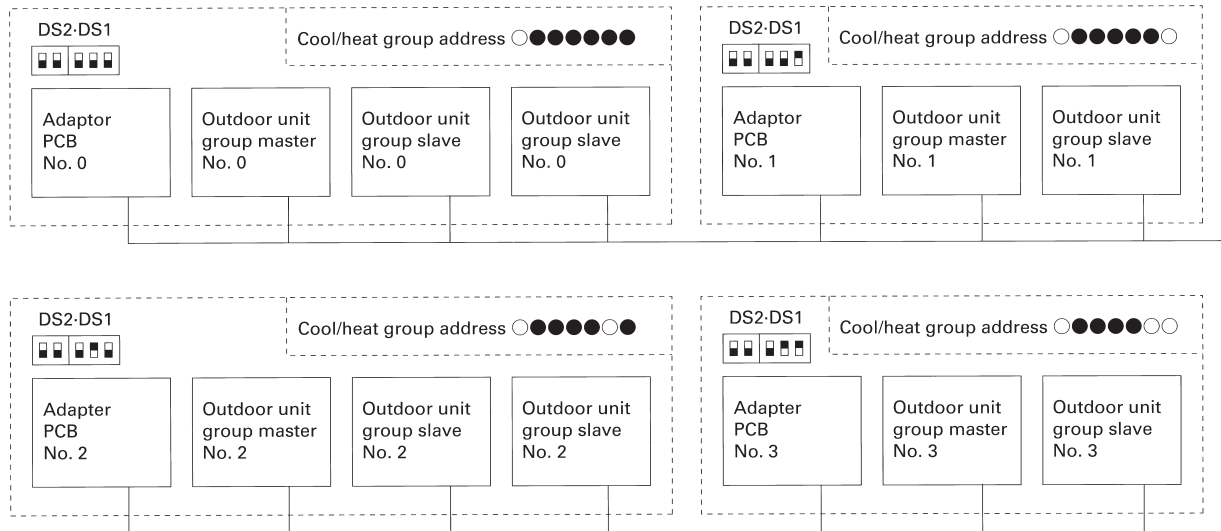

(3) and (4) address setting method (combine lower 5 digits as binary number)

Address No.	Outdoor unit PC board LED Set in setting mode 2	PC board adaptor	
		DS2	DS1
No 0	○● ●●●●● 0	Up (ON) Up (ON) Up (ON) Up (ON) Up (ON)	0
No 1	○● ●●●●○	Up (ON) Up (ON) Up (ON) Up (ON) Down (OFF)	1
No 2	○● ●●●○●	Up (ON) Up (ON) Up (ON) Down (OFF) Up (ON)	2
No 3	○● ●●●○○	Up (ON) Up (ON) Up (ON) Down (OFF) Down (OFF)	3
No 4	○● ●●○●●	Up (ON) Up (ON) Down (OFF) Up (ON) Up (ON)	4
⋮		⋮	
No30	○● ○○○○●	Down (OFF) Down (OFF) Down (OFF) Down (OFF) Up (ON)	30
No31	○● ○○○○○	Down (OFF) Down (OFF) Down (OFF) Down (OFF) Down (OFF)	31

○ On ● Off

Up (ON) Down (OFF)

(The black part represents the switch.)



7. Low Noise / Demand Operation

External control adaptor for outdoor unit is required for each low noise and demand control zone.

- By using a separate External control adaptor for outdoor unit and setting the outdoor unit address (setting mode 2) for each low noise and demand control zone, demand and low noise operation is carried out in accordance with contact input received from the adaptor in each zone.

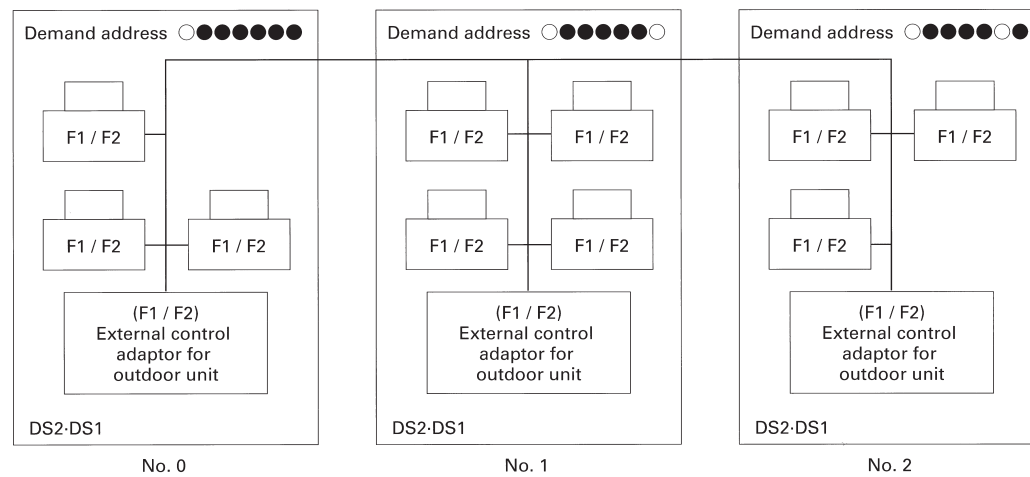

- Outdoor unit address setting (Setting mode 2; see page 42.)
- External control adaptor for outdoor unit address setting
 - Decide and set demand address 0 - 31 for each demand and low noise control zone. (See fig. below.)
 - Set SS1 to "BOTH" (factory set) or "C / H."

Demand No.	Outdoor unit PCB LED Set in setting mode 2	External control adaptor for outdoor unit		Demand No.	Demand Address	Switch Settings
		DS2	DS1			
No 0	00000000	Up	Up	No 11	00000000	Up, Up, Up, Up, Up
No 1	00000001	Up	Down	No 12	00000001	Up, Up, Up, Up, Down
No 2	00000002	Up	Up	No 30	00000010	Up, Up, Up, Down, Up
No 3	00000003	Up	Down	No 31	00000000	Up, Up, Up, Up, Up

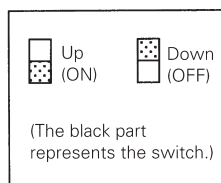

Wiring method

Wire to the control box for the indoor unit or BS unit. (Note: Differs according to the type of outside control adaptor.)

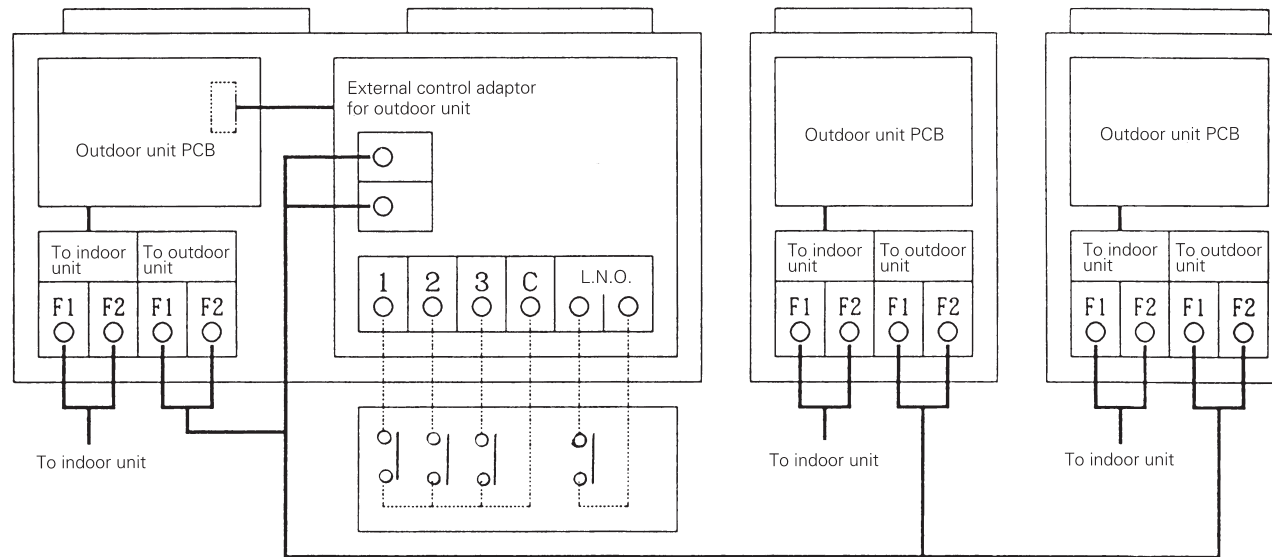

Demand / low noise input

- Short circuit between Demand 1 and C: Holds demand down to approx. 70%
- Short circuit between Demand 2 and C: Holds demand down to approx. 40%
- Short circuit between Demand 3 and C: Forced OFF by thermostat
- L.N.O (jumper): Carries out low noise operation.

Input signal

Input current by constant contact a is about 10 mA per contact. Use a micro-current contact for the relay contact.

Exterior wiring specifications for demand and low noise operation
Recommended wiring: Sheathed vinyl cord or cable
Wiring length : 150 m
Keep away from power line in order to prevent malfunction.

8. Wiring Check Operation

If within 12 hours of stopping cooling or heating, be sure to run all indoor units in the system you want to check in the fan mode for about 60 minutes in order to prevent mis-detection.

Operation method

1. In the monitor mode, check the number of connected indoor units. (See monitor mode.)
2. Push and hold the WIRING CHECK button (BS4) for 5 seconds to perform wiring check operation.
While running, TEST (H2P) lights and goes off when finished.
If TEST (H2P) flickers (wiring check operation failure), push and hold the RESET button (BS5) for 5 seconds, and then repeat the procedure from the beginning.
3. About 1 minute after you finish running the system, once again check the number of connected indoor units in the monitor mode and make sure the number agrees with the first time you checked. If not, it indicates that there is a wiring mistake. Fix the wiring of the indoor unit whose remote controller displays "UF" when its ON/OFF switch is turned ON.

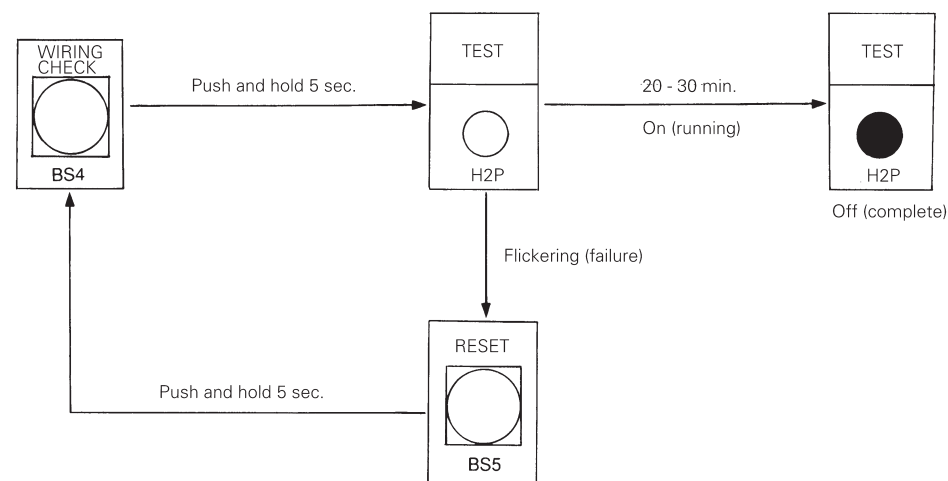

NOTE: Other settings are not accepted during wiring check operation.

9. Indoor Unit PCB Ass'y

The indoor unit PCB ass'y is equipped with terminals for control wiring and connectors for optional control accessories .
Group No. setting for central control and various operation setting switches, etc., are set by indoor unit remote controller.

Ceiling mounted cassette type (double flow type): FXYC-K

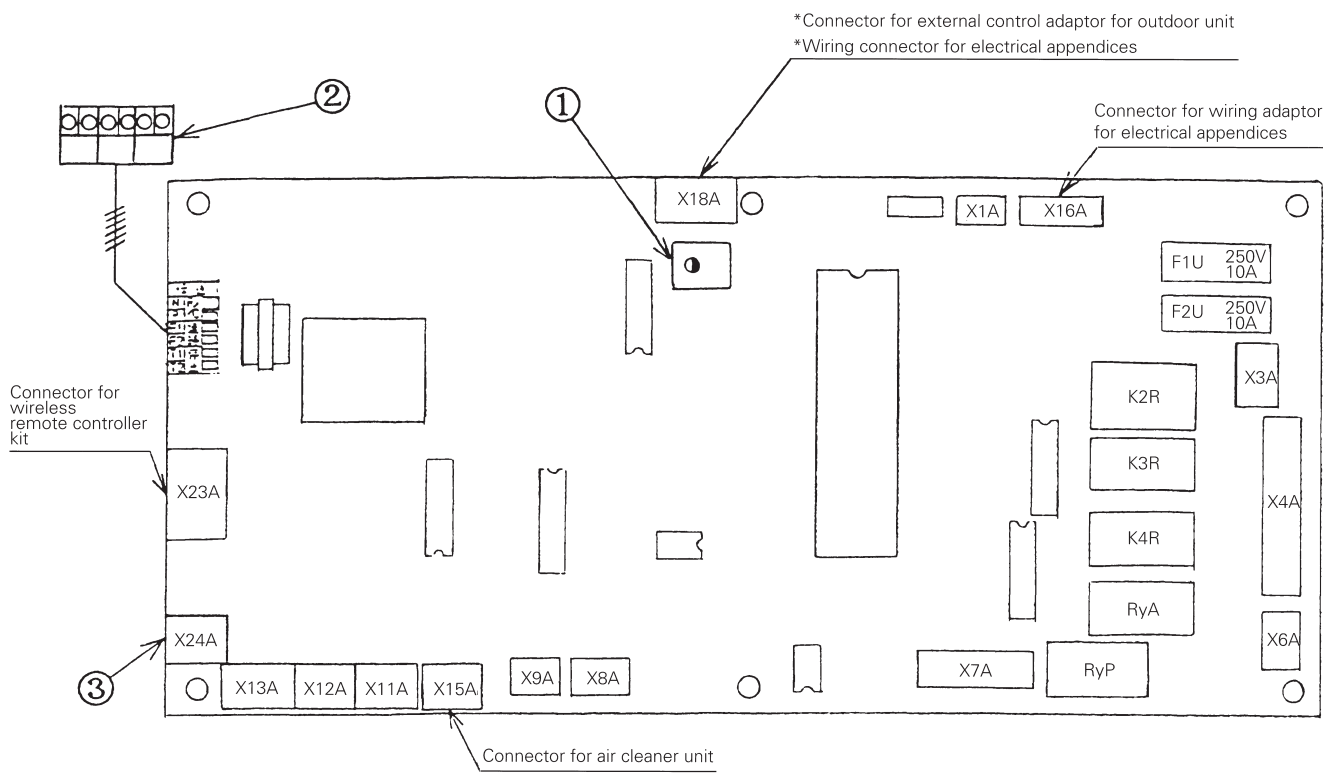

① Service Monitor [HAP] (Green)	Lets you check the function status of the microcomputer. Normal : Flicker Malfunction : On or off												
② Transmission wiring terminal	Terminal for remote controller wiring, indoor - outdoor unit transmission wiring (central wiring), and wiring for outside input <table border="1" data-bbox="1045 1834 1486 1938"> <thead> <tr> <th colspan="2">Remote controller</th> <th colspan="2">Transmission wiring</th> <th colspan="2">Outside input</th> </tr> </thead> <tbody> <tr> <td>N</td> <td>P</td> <td>F1</td> <td>F2</td> <td>T1</td> <td>T2</td> </tr> </tbody> </table>	Remote controller		Transmission wiring		Outside input		N	P	F1	F2	T1	T2
Remote controller		Transmission wiring		Outside input									
N	P	F1	F2	T1	T2								
③ Connector for capacity setting adaptor	Connector for inserting the capacity setting adaptor for when replacing with auxiliary PC board. The adaptor is required for all models. ※Fan phase control for FXYF, FXYH and FXYA only.												

Все каталоги и инструкции здесь: <https://splitssystema48.ru/instrukcii-po-ekspluatatsii-kondicionerov.html>



10. Remote Controllers (Wired and Wireless)

By making use of optional liquid crystal indoor unit remote controller switches, you can construct a versatile control system. The remote controller control wiring for simplified remote controllers (BRC2A51/3A61) is the same as that of standard remote controllers (BRC1A51/1A52), but since the functions of the simplified remote controllers are limited, we recommend they should be used together with a central remote controller.

■ Appearance / functions

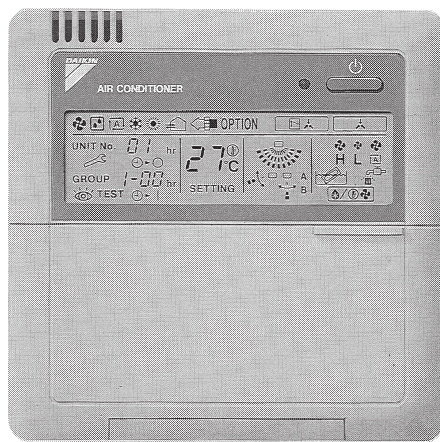

- Large liquid crystal screen that displays operating status in detail.
- Preset temperature is indicated in digital display, and can be set in 1°C increments.
- Enables independent operation without the remote controller for HRV as well as operation interlocked with HRV total heat exchanger units. (Applies only to B Series and multifunctional types)
- Display of malfunction is also available for air cleaner units.
- Operation can be individually programmed to start and stop time up to 72 hours in advance.
- The remote controller is equipped with a thermostat sensor to realize better room temperature control.
- Room temperature and preset temperature are monitored by microcomputer, and cool/heat operation mode is selected automatically. (Applies only to simultaneous cool/heat type only)
- Cool, heat or fan operation mode can be selected by any indoor unit remote controller without using the cool/heat selector switch. (Applies to all VRV System equipment)
- The system can be monitored for malfunctions covering 40 items. Equipped with a "self-diagnosis function" which displays a message to let you know immediately when a malfunction occurs.
- Field settings can be made by remote controller.

■ Remote control example

■ Cool/heat operation mode selection control

With the VRV System Inverter K Series, you can select the cool/heat operation mode for outdoor units in the same system with an indoor unit remote controller.

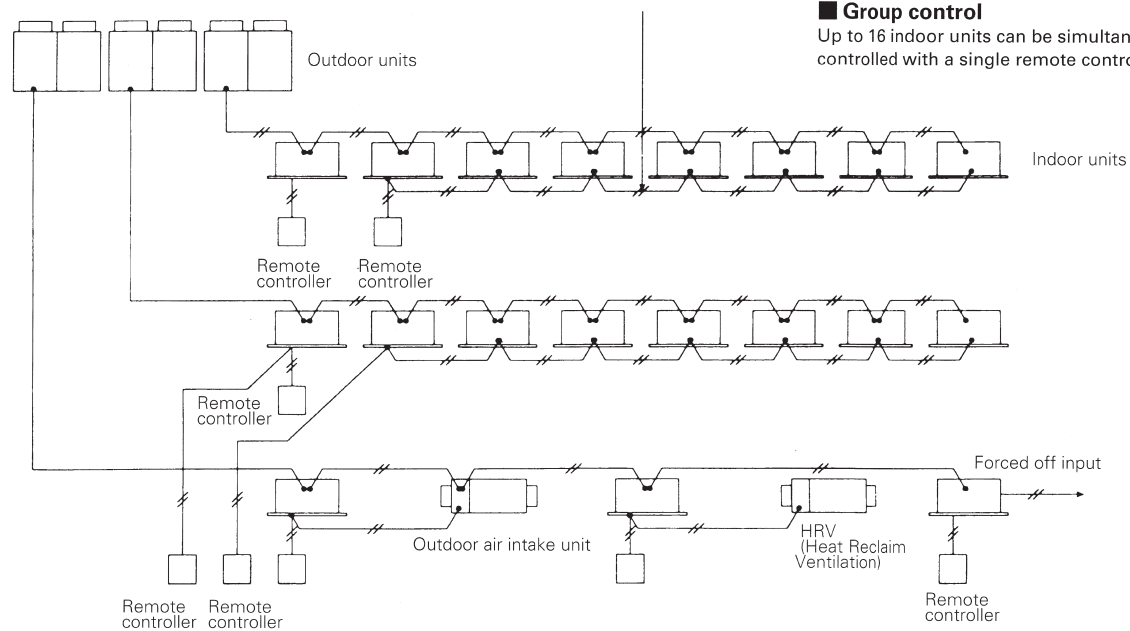

■ Group control

Up to 16 indoor units can be simultaneously controlled with a single remote controller.

■ Control by 2 remote controllers

By connecting two remote controllers to a single indoor unit, you can for instance freely control from both in the room and from the control room (individual control), not to mention that you can carry out group control with two remote controllers.

■ Electrical appendices

Remote controller wiring can be extended up to 500 meters, and you can easily make a central control setup in one place with indoor unit remote controllers set up in various places around the room.

■ Interlock control

You can simultaneously control HRV total heat exchanger units or humidifiers with direct expansion coils via an indoor unit. Also displays cleaning period for air cleaner units.

■ System extension

Allows extension of the system such as a building control system or forced off command input by key control system.

Все каталоги и инструкции здесь: <https://splitssystema48.ru/instrukcii-po-ekspluatatsii-kondicionerov.html>



■ **Applicable remote controller models (wired type)**

Model No.	Applicable types
BRC1A51	Ceiling mounted cassette (multi flow, double flow, corner), ceiling suspended, wall mounted
BRC1A52	Ceiling mounted built-in, ceiling mounted duct, concealed floor standing

■ **Part names and functions**

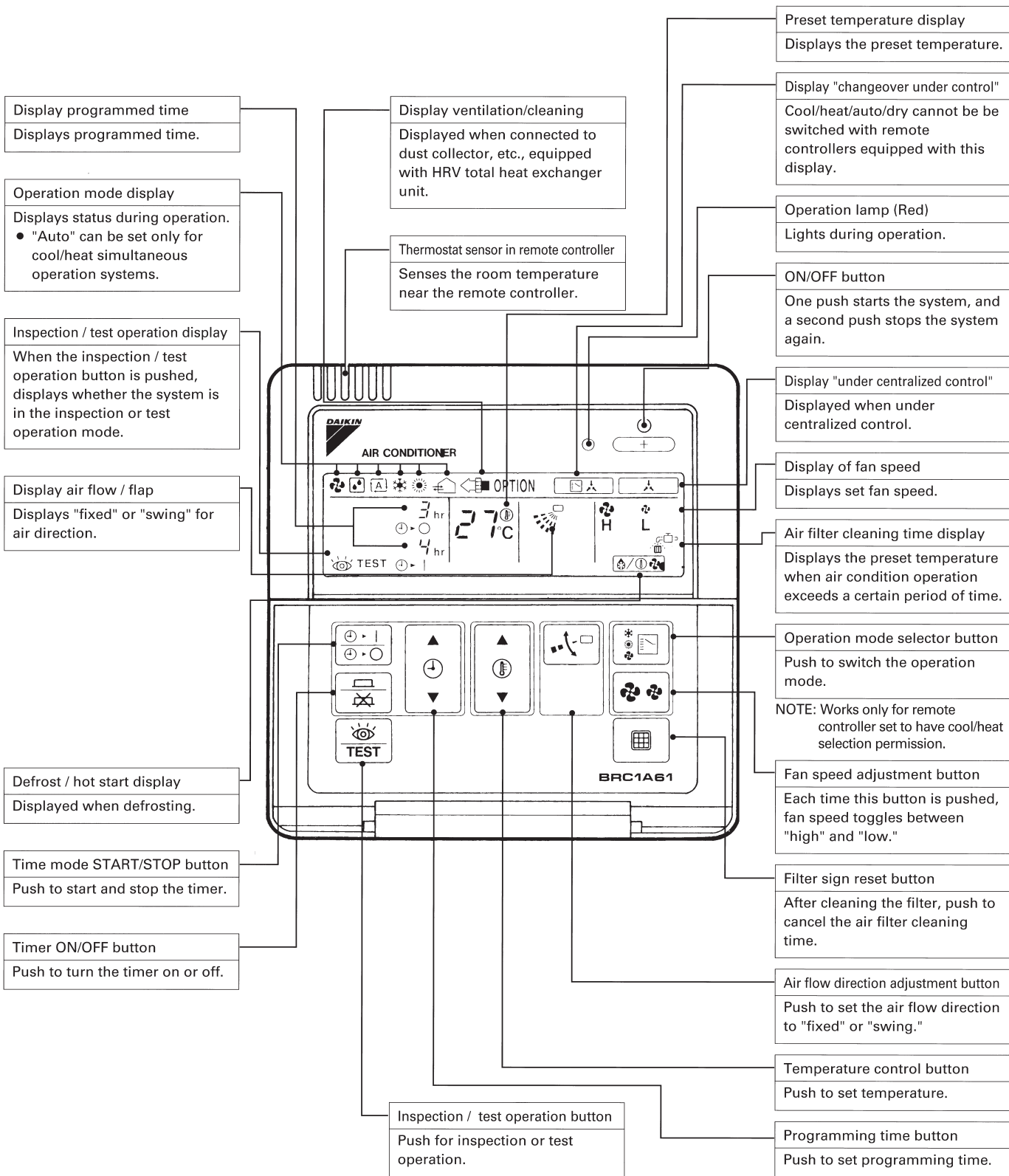



■ **Applicable wireless remote controller models**

Type		FXYC-K	FXYK-K	FXYF-K	FXYS-K	FXYH-K	FXYA-K	FXYL-K FXYLM-K	FXYM-K
Wireless remote controller	H / P	BRC7A62	—	BRC7A51W	BRC4A62	BRC7A63W	BRC7A54W	BRC4A62	BRC4A62
	C / O	BRC7A67	—	BRC7A56W	BRC4A64	BRC7A68W	BRC7A59W	BRC4A64	BRC4A64

■ **Part names and functions**

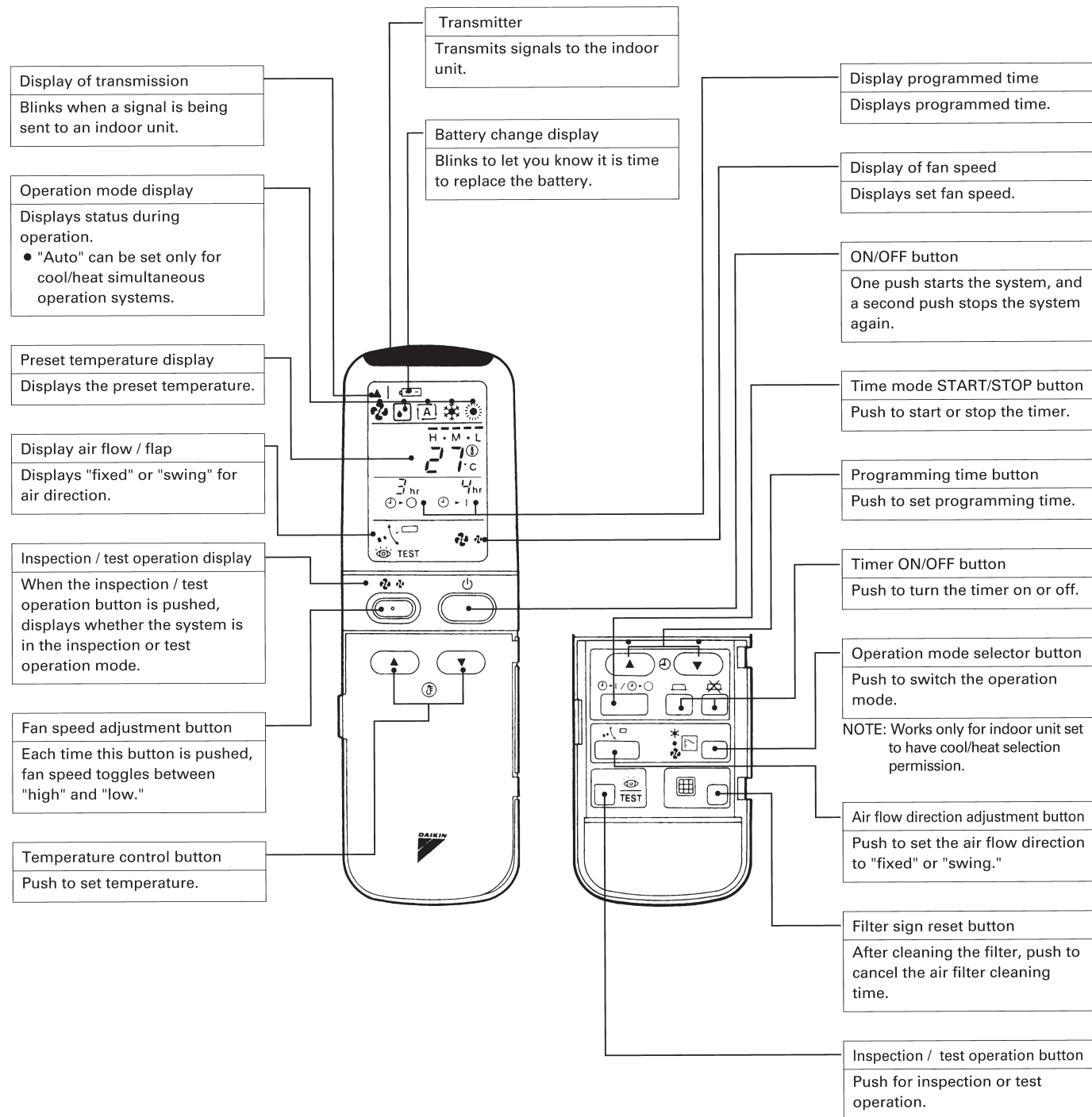

■ Example of system using wireless remote controller

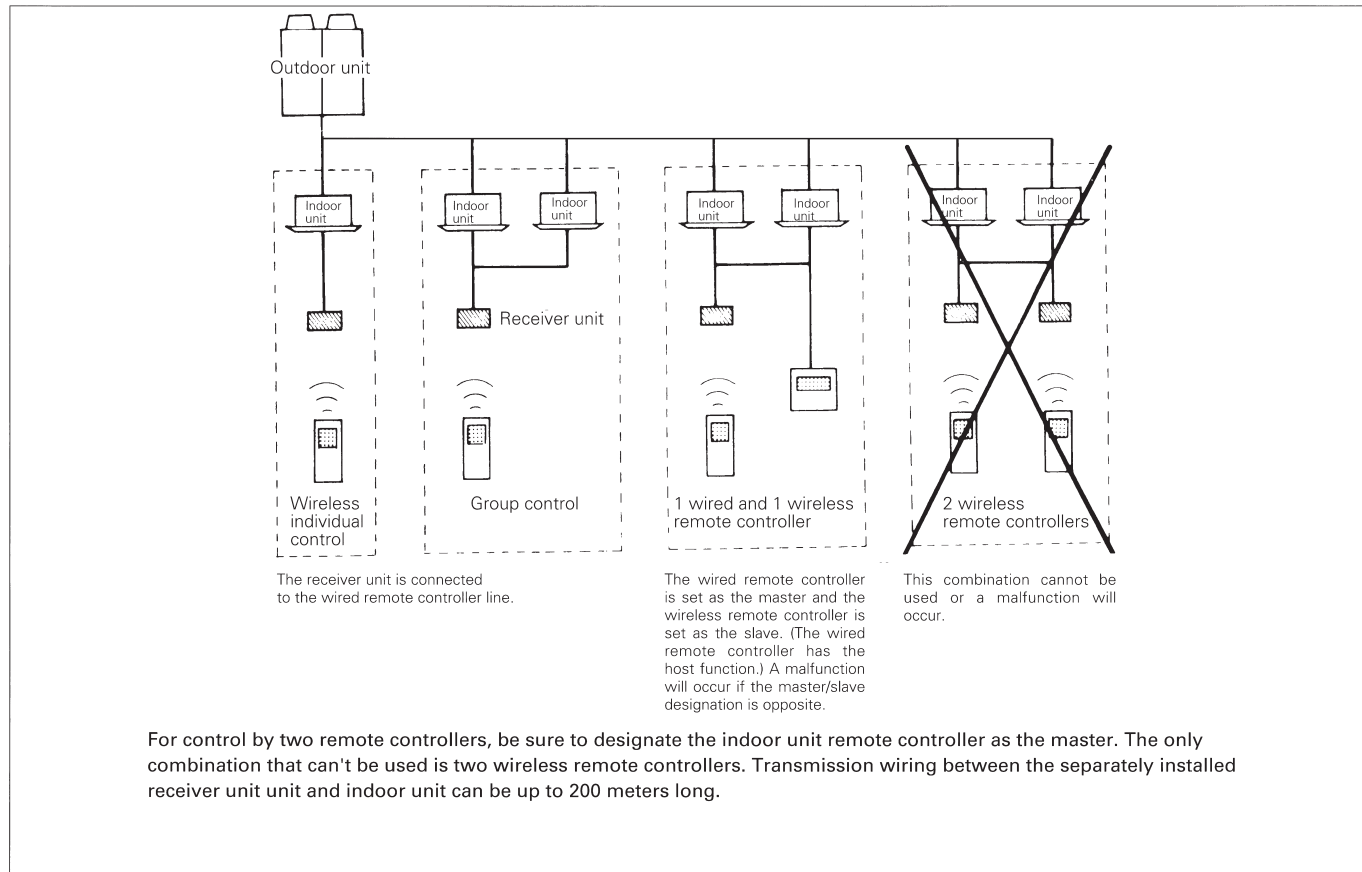

■ Comparison of functions of wired and wireless remote controllers

Function /display	Wired remote controller	Wireless remote controller
Operation lamp	Remote controller LED	Receiver unit LED
ON/OFF	Toggles between on and off each time the button is pushed.	
Operation mode selection	Selects operation mode. Cool/heat mode cannot be switched during changeover under control.	Selects operation mode. Cool/heat display switches during changeover under control.
Air flow direction setting	The air flow direction is set by adjusting with the air flow direction adjustment button while viewing setting position in the liquid crystal display.	The air flow direction is set by adjusting with the air flow direction adjustment button while viewing the position of the louver.
Filter sign reset	Resets the filter and element cleaning display.	Resets the filter and element cleaning display. Displayed by optical sensor LED.

※All operation buttons (preset temperature, fan speed, timer, inspection / test operation, cool/heat selection permission and group No. setting for centralized control) function in the same manner.

Function /display	Wired remote controller	Wireless remote controller
·Display "time to clean air cleaner element" ·Filter sign display	Remote controller LCD display	Displayed by receiver unit LED.
Display "ventilation/cleaning"	Displayed when HRV or air cleaner unit is connected.	"Ventilation/cleaning" displayed by receiver unit LED.
Defrost hot start	Displays defrost and hot start.	Displayed by receiver unit LED.
Display "under centralized control"	Displayed during centralized control.	Not displayed, but you are warned by a buzzer sound emitted from the receiver unit .
Display "changeover under control"	Displayed when cool/heat mode cannot be switched.	Not displayed (you are warned by a buzzer sound when the mode cannot be switched).
Thermostat sensor in remote controller	Equipped	Not equipped
Ventilation mode	Equipped	Not equipped



11. Control by Remote Controller (Double Remote Controllers, Group, Remote)

■ **Double remote controllers:** Lets you control a single indoor unit using two remote controllers in different locations.

System which is convenient for cases where for instance you may want to control an indoor unit in the reception room from your office, or when you may want to have fine control of a far away indoor unit at your fingertips. (Applies to other indoor unit types as well.)

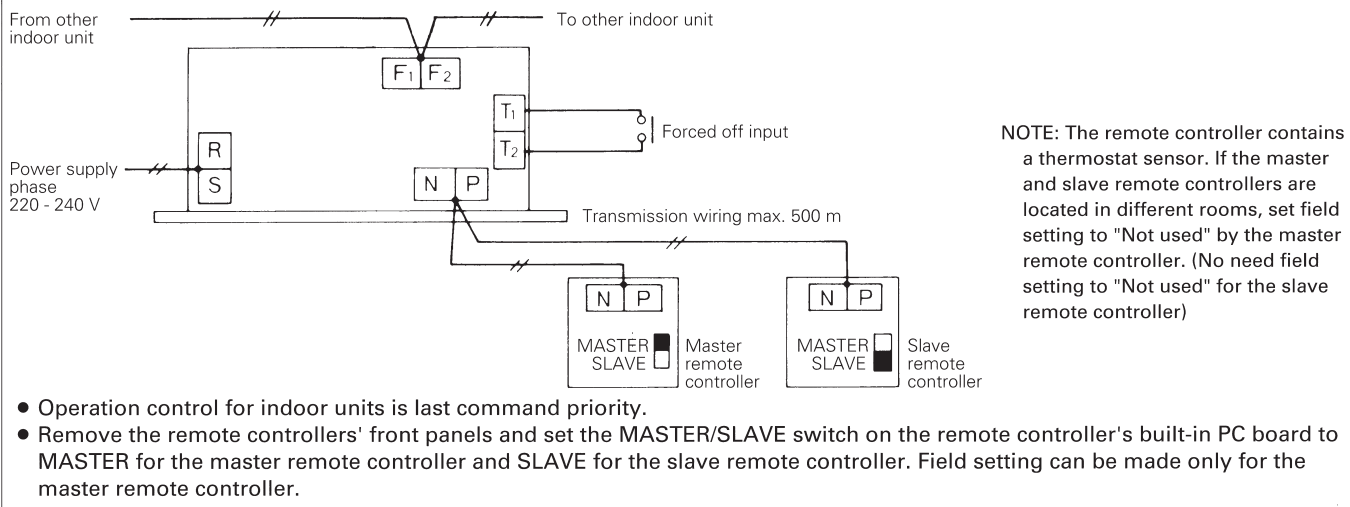

■ **Group control:** Up to 16 indoor units are simultaneously controlled as a group with single remote controller.

System which is convenient for cases where for instance you may want to simultaneously control several indoor units with the same settings, such as on a huge single floor.

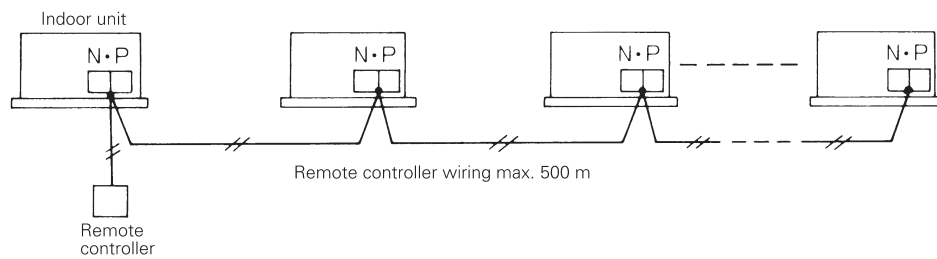

- Remote controller wiring for group control has no polarity, so it doesn't matter if N and P are connected inversely.
- Settings are the same for all indoor units in the group, and each indoor unit is controlled individually by its thermostat sensor.
- Address is set automatically for group control, so there is no need to set the address for by the group control remote controller.

■ **Remote control: Forced OFF or ON/OFF control of indoor units can be input from outside.**

Enables indoor units to be turned on and off by a building control or key control system.

(1) Wiring method and specifications

- Remote control is carried out by connecting input from outside to pins T1 and T2 on the terminal block (for remote controller and transmission wiring)

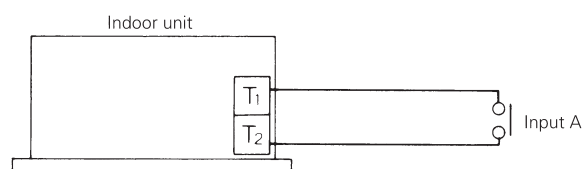

Wiring specifications	Sheathed vinyl cord or cable (double core)
Wiring thickness	0.75~1.25mm ²
Wiring length	MAX 100m
Outside contact specs.	Contact which guarantees min. applicable load of 15 VDC, 10 mA

Forced OFF	ON/OFF control
Forced OFF by input A "ON" (remote controller prohibited)	On by input A "OFF" → "ON"
Remote controller permitted by input A "OFF"	OFF by input A "ON" → "OFF"

(2) Operation contents

- Input A of forced stop and stop operation operates as described in the table on the right.

(3) Forced OFF and ON/OFF control selection

- Switch input by remote controller after turning on the power supply.
- Set field setting mode with the remote controller.
- When you enter the field setting mode, select mode No. 12, and set the first code No. to "1." for forced OFF, set the second code No. to "01," and from ON/OFF control, set to "02." (Factory set is forced OFF.)

Все каталоги и инструкции здесь: <https://splitssystema48.ru/instrukcii-po-ekspluatatsii-kondicionerov.html>









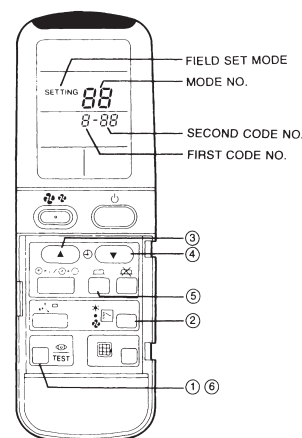
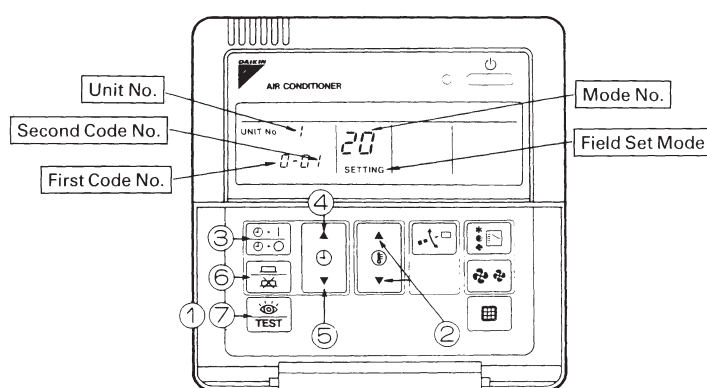

12. Indoor Field Setting







☆Making a field setting

Field settings must be made by remote controller if optional accessories have been installed on the indoor unit, or if the indoor unit or HRV unit's individual functions have been modified.

■ Wired remote controller



- ① When in the normal mode, push the  button for 4 seconds or more, and operation then enters the "field set mode."
- ② Select the desired "mode No." with the  button.
- ③ During group control and you want to set by each individual indoor unit (when mode No. 20, 21, 22, 23, 25 has been selected), push the time mode  button and select the "indoor unit No." to be set.
Note: This operation is not required when setting as a group.
- ④ Push the  button and select the first code No.
- ⑤ Push the  button and select the second code No.
- ⑥ Push the timer  button one time and "define" the currently set contents.
- ⑦ Push the  button to return to the normal mode.

- ① When in the normal mode, push the  button for 4 seconds or more, and operation then enters the "field set mode."
- ② Select the desired "mode No." with the  button.
- ③ Pushing the  button, select the first code No.
- ④ Pushing the  button, select the second code No.
- ⑤ Push the timer  button and check the settings.
- ⑥ Push the  button to return to the normal mode.

- NOTES: 1. Settings are made simultaneously for the entire group, however, if you select the mode No. inside parentheses, you can also set by each individual unit. Setting changes however cannot be checked except in the individual mode for those in parentheses.
2. The mode numbers inside parentheses cannot be used by wireless remote controllers, so they cannot be set individually. Setting changes also cannot be checked.
3. Mode numbers 17 (27) and 19 (29) are HRV functions that can be set from a VRV system remote controller.
4. The second code No. is factory set to "01." The field set air flow direction position and thermostat sensor in remote controller is however set to "02," and ventilation fan speed is set to "05."
5. Do not make settings other than those described above. Nothing is displayed for functions the indoor unit is not equipped with.
6. "88" may be displayed to indicate the remote controller is resetting when returning to the normal mode.



● Setting contents and code No.

Mode No. Note 2	First Code No.	Setting Contents	Second Code No.(Note 3)							
			01		02		03		04	
10(20)	0	Filter contamination heavy/light (Setting for display time to clean air filter) (Sets display time to clean air filter to half when there is heavy filter contamination.)	Super long life filter	Light	Approx. 10,000 hrs.	Heavy	Approx. 5,000 hrs.	_____	_____	
			Long life filter	Approx. 2,500 hrs.	Approx. 1,250 hrs.					
			Standard filter	Approx. 200 hrs.	Approx. 100 hrs.					
	1	Long life filter type (FXYC only, 01 indicates long life)	Long life filter	Super long life filter	_____	Soot filter				
2	Thermostat sensor in remote controller	Use	No use	_____	_____					
3	Display time to clean air filter calculation (Set when filter sign is not to be displayed.)	Display	No display	_____	_____					
12(22)	0	Optional accessories output selection (field selection of output for adaptor for wiring)	Indoor unit turned ON by thermostat	_____	Operation output	Malfunction output				
	1	ON/OFF input from outside (Set when ON/OFF is to be controlled from outside.)	Forced OFF	ON/OFF control	External protection device	_____				
	2	Thermostat differential changeover (Set when remote sensor is to be used.) FXYC, FXYF, FXYK, FXYH only	1°C	0.5°C	_____	_____				
	3	OFF by thermostat fan speed	LL	Set fan speed	_____	_____				
	4	Automatic mode differential (automatic temperature differential setting for VRV system heat recovery series cool/heat)	01:0 02:1	03:2 04:3	05:4 06:5	07:6 08:7				
	5	Power failure automatic reset	Not equipped	Equipped	_____	_____				
13(23)	0	High air outlet velocity (Set when installed in place with ceiling higher than 2.7 m.) FXYF only	N	H	_____	_____				
	1	Selection of air flow direction (Set when a blocking pad kit has been installed.) FXYF only	F (4 directions)	T (3 directions)	W (2 directions)	_____				
	2	Horizontal air discharge	Equipped	Not equipped	_____	_____				
	3	Air flow direction adjustment (Set at installation of decoration panel.) FXYK only	Equipped	Not equipped	_____	_____				
	4	Field set air flow position setting	Draft prevention	Standard	Ceiling Soiling prevention	_____				
	5	Field set fan speed selection (fan speed control by air discharge outlet for phase control)	Standard	Optional accessory 1	Optional accessory 2	_____				
15(25)	1	Thermostat OFF excess humidity	Not equipped	Equipped	_____	_____				
	3	Drain pump humidifier interlock selection	Not equipped	Equipped	_____	_____				
	4	Sets whether filter sign is to be output by time or by input.	Time addition	Input	_____	_____				
	5	Field set selection for individual ventilation setting by remote controller	Not equipped	Equipped	_____	_____				
	6	Field set selection for individual ventilation setting by remote controller	Not equipped	Equipped	_____	_____				

For HRV settings, see the proper documents for HRV.

Все каталоги и инструкции здесь: <https://splitssystema48.ru/instrukcii-po-ekspluatatsii-kondicionerov.html>



13. Centralized Control Group No. Setting

■ Centralized control group No. setting

- If carrying out centralized control by central remote controller or unified ON/OFF controller, group No. must be set for each group individually by remote controller.
- Group No. setting by remote controller for centralized control

1. When in the normal mode, push the button for 4 seconds or more, and operation then enters the "field setting mode."
2. Set mode No. "00" with the button. ※
3. Push the button to inspect the group No. display.
4. Set the group No. for each group with the button (The group No. increases in the manner of 1-00, 1-01, ..., 1-15, 2-00, ..., 4-15. However, the unified ON/OFF controller displays only the group No. within the range selected by the switch for setting each address.)
5. Push the timer button to define the selected group No.
6. Push the button to return to the normal mode.

- Set the group No. after turning on the power supply for the central remote controller, unified ON/OFF controller, and indoor unit.
- Group No. setting by wireless remote controller for centralized control

- ① When in the normal mode, push button for 4 seconds or more, and operation then enters the "field set mode."
- ② Set mode No. "00" with button.
- ③ Set the group No. for each group with button (advance/backward).
- ④ Enter the selected group numbers by pushing button.
- ⑤ Push button and return to the normal mode.

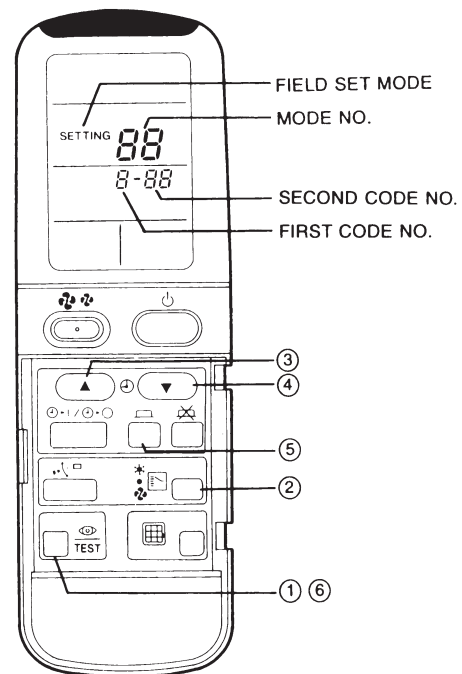
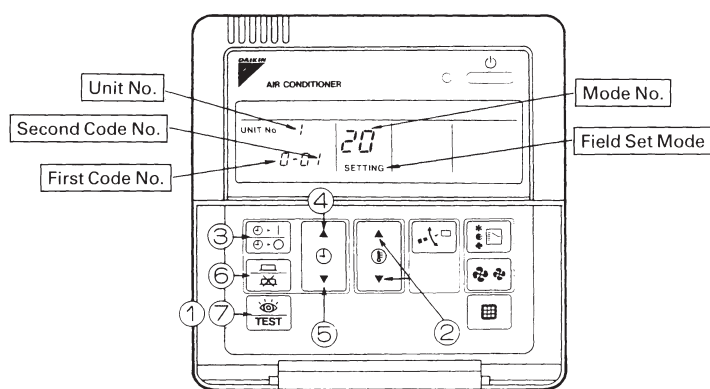

- Even if not using a remote controller, connect the remote controller when setting the group No., set the group No. for centralized control, and disconnect after making the setting.
- Group No. setting example

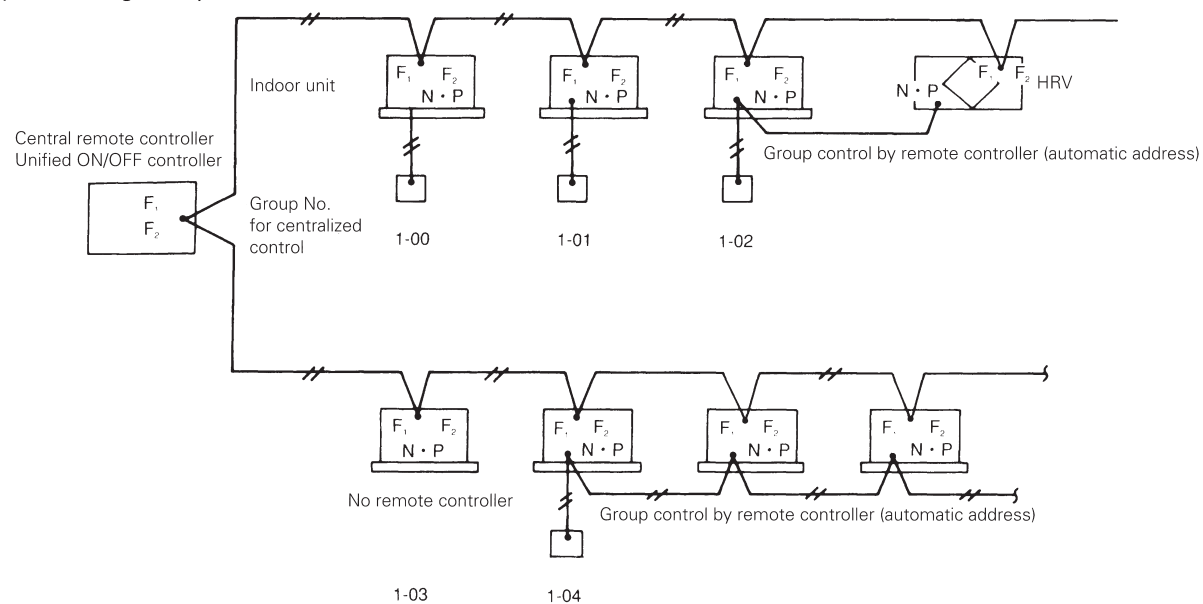

※If you have to set the address for each unit for calculating cost, etc., set the mode No. to "30."

Все каталоги и инструкции здесь: <https://splitsystem48.ru/instrukcii-po-ekspluatatsii-kondicionerov.html>



14. Setting of Master Remote Controller

■ Setting of master remote controller by indoor unit remote controller

- Operation mode (Fan, Dry, Cool, Heat) can be freely selected by indoor unit remote controller for the EX III series outdoor units, however, as shown in the example below, the remote controller of one of the indoor units connected to 1 outdoor unit must be set as the master remote controller for Fan, Dry, Cool, Heat.
(Operation mode can be switched by only the remote controller set as the master remote controller.)

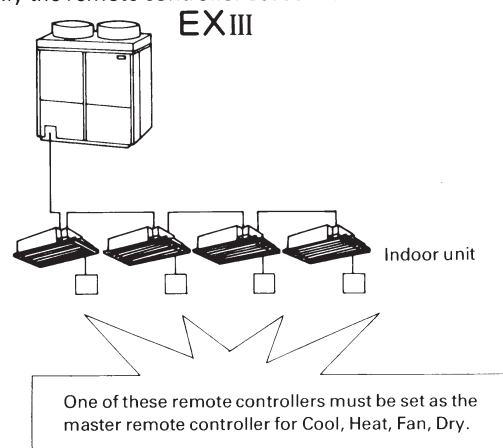

● Setting method

Preparations

- When turning the power supply on for the first time, the display of **CHANGEOVER UNDER CONTROL** lights when the power supply is turned on.

When you want to set:

1 Set the outdoor unit's cool/heat selector (Field setting mode1) to inside.

Setting of master remote controller

2 Continue pushing **OPERATION MODE SELECTOR** for about 4 seconds. The display of **CHANGEOVER UNDER CONTROL** on all remote controllers connected to the same outdoor unit blinks.

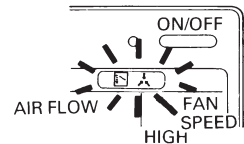

Setting of master remote controller

3 Push the **OPERATION MODE SELECTOR** of the remote controller you want to set as the master remote controller. This completes the setting. The remote controller is now set as the master remote controller and the display of **CHANGEOVER UNDER CONTROL** goes off. **CHANGEOVER UNDER CONTROL** is displayed on the other remote controllers.

Operation mode selection

4 Push the **OPERATION MODE SELECTOR** of the master remote controller (remote controller not displaying **CHANGEOVER UNDER CONTROL**) the amount of times required to select the desired operation mode. Each push switches the display from FAN to DRY, COOL, and HEAT. The operation mode changes automatically for all remote controllers that are not set as a master remote controller.

● Operation contents and function

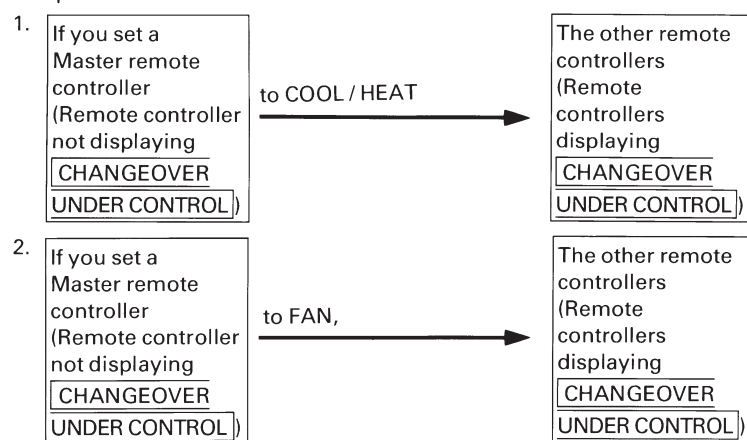

- switch to the operation mode set by the master remote controller.
- However, they can switch to FAN operation and from COOL to DRY.

- cannot set any mode other than FAN.



15. Remote Controller Self-Diagnosis Function

The remote controller switches are equipped with a self diagnosis function so that more appropriate maintenance can be carried out. If a malfunction occurs during operation, the operation lamp, malfunction code and display of malfunctioning unit No. let you know the contents and location of the malfunction.

When there is a stop due to malfunction, the contents of the malfunction given below can be diagnosed by a combination of operation lamp, INSPECTION display of the liquid crystal display and display of malfunction code. It also lets you know the unit No. during group control.

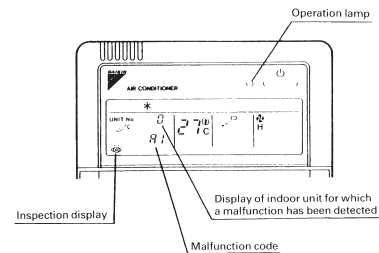

Operation lamp	Inspection display	Unit No.	Malfunction code	Malfunction contents
Blinking	Blinking	Blinking	A0	Indoor unit: Error of external protection device
Blinking	Blinking	Blinking	A1	Indoor unit: Failure of PC board
On	Off	Blinking	A1	Indoor unit: Failure of PC board
Blinking	Blinking	Blinking	A3	Indoor unit: Malfunction of drain level control system (33H)
Blinking	Blinking	Blinking	A6	Indoor unit: Fan motor lock
On	Off	Blinking	A7	Indoor unit: Malfunction of swing flap motor (M1S)
Blinking	Blinking	Blinking	A9	Indoor unit: Malfunction of moving part of electronic expansion valve (Y1E)
On	Off	Blinking	AF	Indoor unit: Drain level above limit
Blinking	Blinking	Blinking	AH	Indoor unit: Malfunction of air cleaner
Blinking	Blinking	Blinking	AJ	Indoor unit: Malfunction of capacity setting
Blinking	Blinking	Blinking	C4	Indoor unit: Malfunction of thermistor (R2T) for liquid pipe (loose connection, disconnection, short circuit, failure)
Blinking	Blinking	Blinking	C5	Indoor unit: Malfunction of thermistor (R3T) for gas pipes (loose connection, disconnection, short circuit, failure)
Blinking	Blinking	Blinking	C9	Indoor unit: Malfunction of thermistor (R1T) for air inlet (loose connection, disconnection, short circuit, failure)
On	On	On	CJ	Indoor unit: Malfunction of thermostat sensor in remote controller
Blinking	Blinking	Blinking	E0	Outdoor unit: Actuation of safety device
Blinking	Blinking	Blinking	E1	Outdoor unit: PC board failure
On	Off	Blinking	E1	Outdoor unit: PC board failure
Blinking	Blinking	Blinking	E3	Outdoor unit: Actuation of high pressure switch
Blinking	Blinking	Blinking	E4	Outdoor unit: Actuation of low pressure switch
Blinking	Blinking	Blinking	E9	Outdoor unit: Malfunction of moving part of electronic expansion valve (Y1E)
Blinking	Blinking	Blinking	F3	Outdoor unit: Abnormal discharge pipe temperature
On	Off	Blinking	H3	Outdoor unit: High pressure switch failure
Blinking	Blinking	Blinking	H4	Outdoor unit: Actuation of low pressure switch
Blinking	Blinking	Blinking	H9	Outdoor unit: Malfunction of thermistor (R1T) for outdoor air (loose connection, disconnection, short circuit, failure)
On	Off	Blinking	H9	Outdoor unit: Malfunction of thermistor (R1T) for outdoor air (loose connection, disconnection, short circuit, failure)
Blinking	Blinking	Blinking	J1	Outdoor unit: Malfunction of pressure sensor
Blinking	Blinking	Blinking	J3	Outdoor unit: Malfunction of discharge pipe thermistor (R3T) (loose connection, disconnection, short circuit, failure)
On	Off	Blinking	J3	Outdoor unit: Malfunction of discharge pipe thermistor (R3T) (loose connection, disconnection, short circuit, failure)
Blinking	Blinking	Blinking	J5	Outdoor unit: Malfunction of thermistor (R4T) for suction pipe (loose connection, disconnection, short circuit, failure)
Blinking	Blinking	Blinking	J6	Outdoor unit: Malfunction of thermistor (R2T) for heat exchanger (loose connection, disconnection, short circuit, failure)
On	Off	Blinking	J6	Outdoor unit: Malfunction of thermistor (R2T) for heat exchanger (loose connection, disconnection, short circuit, failure)
Blinking	Blinking	Blinking	JA	Outdoor unit: Malfunction of discharge pipe pressure sensor
Blinking	Blinking	Blinking	JC	Outdoor unit: Malfunction of suction pipe pressure sensor
On	Off	Blinking	JH	Outdoor unit: Malfunction of oil temperature sensor
Blinking	Blinking	Blinking	L0	Outdoor unit: Failure of inverter system
Blinking	Blinking	Blinking	L4	Outdoor unit: Failure of inverter cooling
Blinking	Blinking	Blinking	L5	Outdoor unit: Compressor motor insulation defect, short circuit, power unit short circuit
Blinking	Blinking	Blinking	L6	Outdoor unit: Compressor motor insulation defect, short circuit
Blinking	Blinking	Blinking	L8	Outdoor unit: Compressor overload, compressor unit wire cut
Blinking	Blinking	Blinking	L9	Outdoor unit: Compressor lock
Blinking	Blinking	Blinking	LA	Outdoor unit: Malfunction of power unit
Blinking	Blinking	Blinking	LC	Outdoor unit: Malfunction of transmission between inverter and outdoor control unit
Blinking	Off	Blinking	PO	Gas depletion (heat build up)
Blinking	Blinking	Blinking	P1	Outdoor unit: Power supply voltage imbalance, open phase
Blinking	Blinking	Blinking	P4	Outdoor unit: Malfunction of power unit temperature sensor
On	Off	Blinking	U0	Refrigerant shortage, low pressure drop due to failure of electronic expansion valve
Blinking	Blinking	Blinking	U1	Negative phase / open phase
Blinking	Blinking	Blinking	U2	Power supply insufficient or instantaneous failure
Blinking	Blinking	Blinking	U4	Malfunction of transmission between indoor unit and outdoor unit / BS unit, or outdoor unit and BS unit
Blinking	Blinking	Blinking	U5	Malfunction of transmission between remote controller and indoor unit
Off	On	Off	U5	Failure of remote controller PC board or setting during control by remote controller



Все каталоги и инструкции здесь: <https://splitssystema48.ru/instrukcii-po-ekspluatatsii-kondicionerov.html>

Operation lamp	Inspection display	Unit No.	Malfunction code	Malfunction contents
Blinking	Blinking	Blinking	U7	Malfunction of transmission between indoor units Malfunction of transmission between outdoor units, malfunction of transmission between outdoor unit and ice build-up heat unit
On	Off	Blinking	U7	Malfunction of transmission between outdoor units (cool/heat unified, low noise)
Blinking	Blinking	Off	U8	Malfunction of transmission between master remote controller and slave remote controller (malfunction of slave remote controller)
Blinking	Blinking	Blinking	U9	Malfunction of transmission between indoor unit and outdoor unit in same system Malfunction of transmission between BS unit and indoor/outdoor unit in same system
Blinking	Blinking	Blinking	UA	Failure of combination of indoor / BS / outdoor units (model, No. of units, etc.) Failure of combination of indoor unit and remote controller (applicable remote controller)
On	On	On	UC	Address duplication of central remote controller
Blinking	Blinking	Blinking	UE	Malfunction of transmission between indoor unit and central remote controller
Blinking	Blinking	Blinking	UF	System not set
Blinking	Blinking	Blinking	UH	Failure of system

The system operates for malfunction codes indicated in black squares, however, be sure to check and repair.



Failure diagnosis by wireless remote controller

The indoor unit display section or the separately installed receiver unit's operation lamp blinks for stop due to malfunction. You can diagnose the problem as described on the following page using the malfunction code located by the method described below.

- Push the  button;  is displayed and "0" blinks.
- Push the time mode  button and locate the number of the unit which is stopped due to malfunction. A beep is then emitted to indicate signal reception.

No. of times signal reception beep is emitted

3 times	Perform the procedure given below in the order of 3, 4, 5, 6.
1 time	Perform steps 3 and 6.
Continuous beep	No malfunction

- Push the operation mode selector button, and the upper digit of the malfunction code blinks.
- Push the time mode  button until signal reception beeps twice, and then locate the upper code.
- Push the operation mode selector button, and the lower digit of the malfunction code blinks.
- Push the time mode  button until signal reception beeps continuously, and then locate the lower code.

Continuous signal reception beep indicates that the malfunction code has been ascertained.

Note 1: "INSPECTION" display blinks when the remote controller's  button is pushed.

Note 2: If you push and hold the ON/OFF button for 5 seconds or more in the INSPECTION mode, the failure hysteresis is canceled. In this case, after the malfunction code blinks twice, the code display changes to "00" (normal) and the unit No. changes to "0." The mode then automatically changes from the inspection mode to the normal mode (preset temperature display).

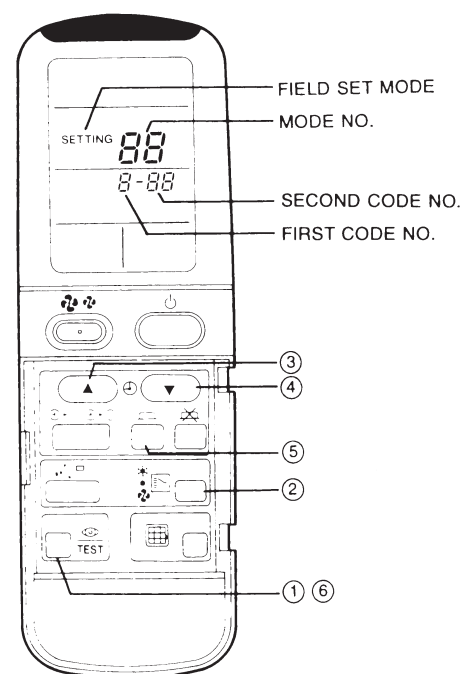

16. Operation of the Remote Controller's Inspection / Test Operation Button

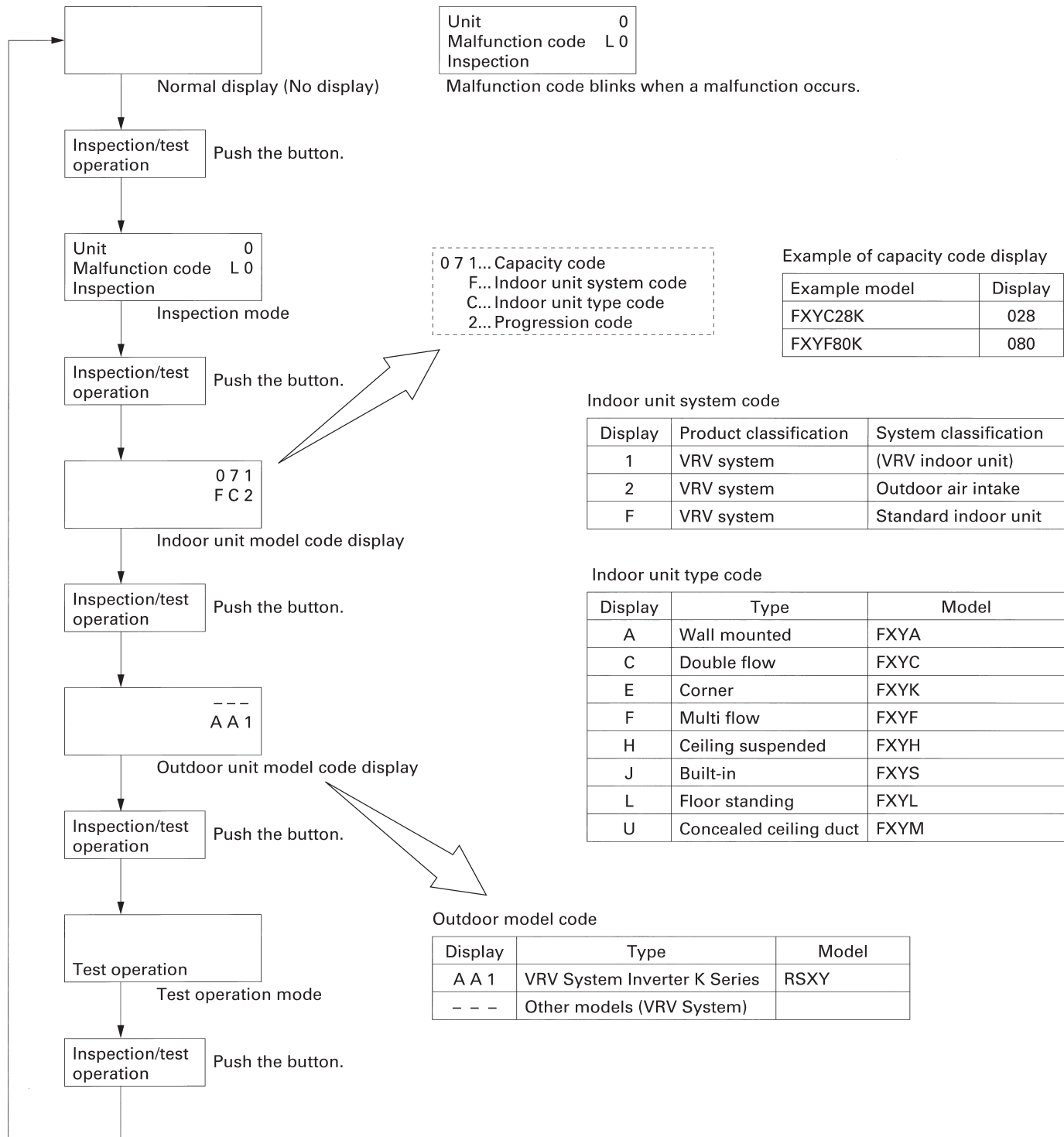



17. Remote Controller Service Mode

[How to enter the service mode]

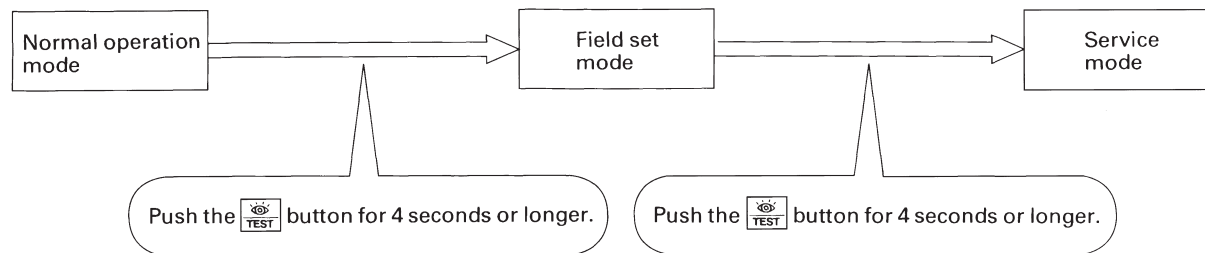









[Service mode operation method]

1. Select the mode No.
 - Set the desired mode No. with the button.
2. Select the unit No. (For group control only)
 - Select the indoor unit No. to be set with the time mode button.
3. Make the settings required for each mode. (Modes 41, 44, 45)
 - For details, refer to the table below.
4. Define the setting contents. (Modes 44, 45)
 - Define by pushing the timer button.
5. Return to the normal operation mode.
 - Push the button one time.





Mode No	Function	Contents and operation method	Remote controller display
40	Malfunction hysteresis display	<p>Display malfunction hysteresis.</p> <p>The hysteresis No. can be changed with the  button.</p>	<p>Unit 1 Malfunction code 40</p> <p>2-U4</p> <p>Malfunction code</p> <p>Hysteresis No: 1 - 9 1: Latest</p>
41	Display of sensor and address data	<p>Display various types of data.</p> <p>Select the data to be displayed with the  button.</p> <p>Sensor data 0: Thermostat sensor in remote controller. 1: Suction 2: Liquid pipe 3: Gas pipe</p> <p>Address data 4: Indoor unit address 5: Outdoor unit address 6: BS unit address 7: Zone control address 8: Cool/heat group address 9: Demand / low noise address</p>	<p>Sensor data display</p> <p>Unit No. Sensor type</p> <p>1 1 2 7 41</p> <p>Temperature °C</p> <p>Address display</p> <p>Unit No. Address</p> <p>1 8 1 41</p> <p>Address</p>
43	Forced fan ON	<p>Manually turn the fan ON by each unit. (When you want to search for the unit No.)</p> <p>By selecting the unit No. with the  button, you can turn the fan of each indoor unit on (forced ON) individually.</p>	<p>Unit 1</p> <p>43</p>
44	Individual setting	<p>Set the fan speed and air flow direction by each unit</p> <p>Select the unit No. with the time mode  button.</p> <p>Set the fan speed with the  button</p> <p>Set the air flow direction with the  button.</p>	<p>Unit 1 Code</p> <p>44</p> <p>1 3</p> <p>Fan speed 1: Low 3: High</p> <p>Air flow direction P0 - P4</p>
45	Unit No. transfer	<p>Transfer unit No.</p> <p>Select the unit No. with the  button.</p> <p>Set the unit No. after transfer with the  button.</p>	<p>Present unit No.</p> <p>Unit 1 Code</p> <p>0 2 45</p> <p>Unit No. after transfer</p>
46	This function is not used by VRV System Inverter K Series.		
47			



18. Model Change of Centralized Control Devices

The following optional controllers for centralized control will be changed from model A to model B, and will be an upgrade in terms of the system. The main modifications are as follows.

■ Main modifications changes (model A to model B)

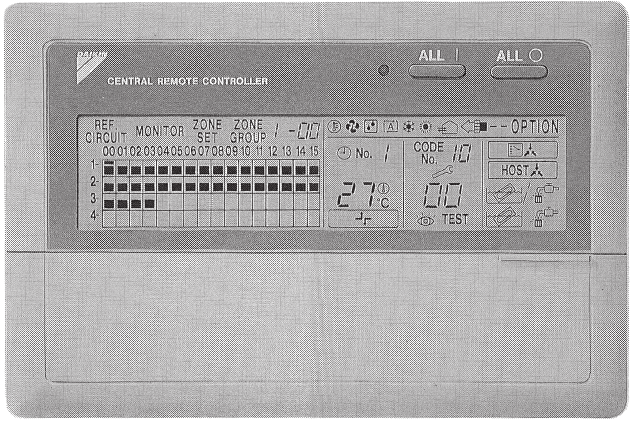
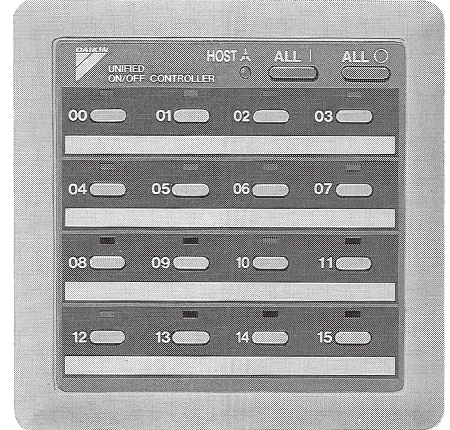
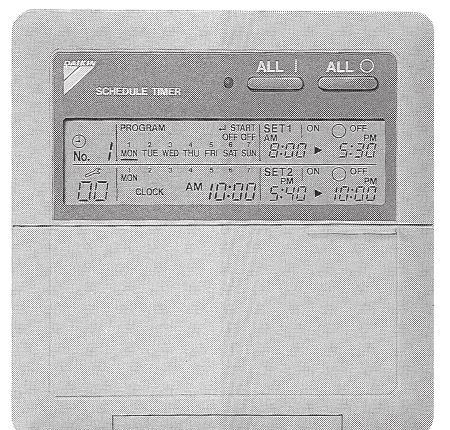
Central remote controller	Model No.	DCS302A51	DCS302B61
	Appearance (Outside dimensions and operation functions are the same.)		
No. of units that can be connected within one control wiring system		1	Up to 2
Unified ON/OFF controller	Model No.	DCS301A51	DCS301B61
	Appearance (Outside dimensions and operation functions are the same.)		
No. of units that can be connected within one control wiring system		Up to 4	Up to 8
Schedule timer	Model No.	DST301A51	DST301B61
	Appearance (Outside dimensions and operation functions are the same.)		
No. of units that can be connected within one control wiring system		1	1
Common	Indoor unit start method	Group start	Sequential start

※ The control range setting (connector or switch) inside the controller is altered to increase the number of units that can be connected within one control wiring system.

Все каталоги и инструкции здесь: <https://splitsystem48.ru/instrukcii-po-ekspluatatsii-kondicionerov.html>



■ **When using model A centralized control device**

- Up to 128 indoor units can be connected within a system. (Group control by remote controller is required if more than 64 units are connected with the same system.)

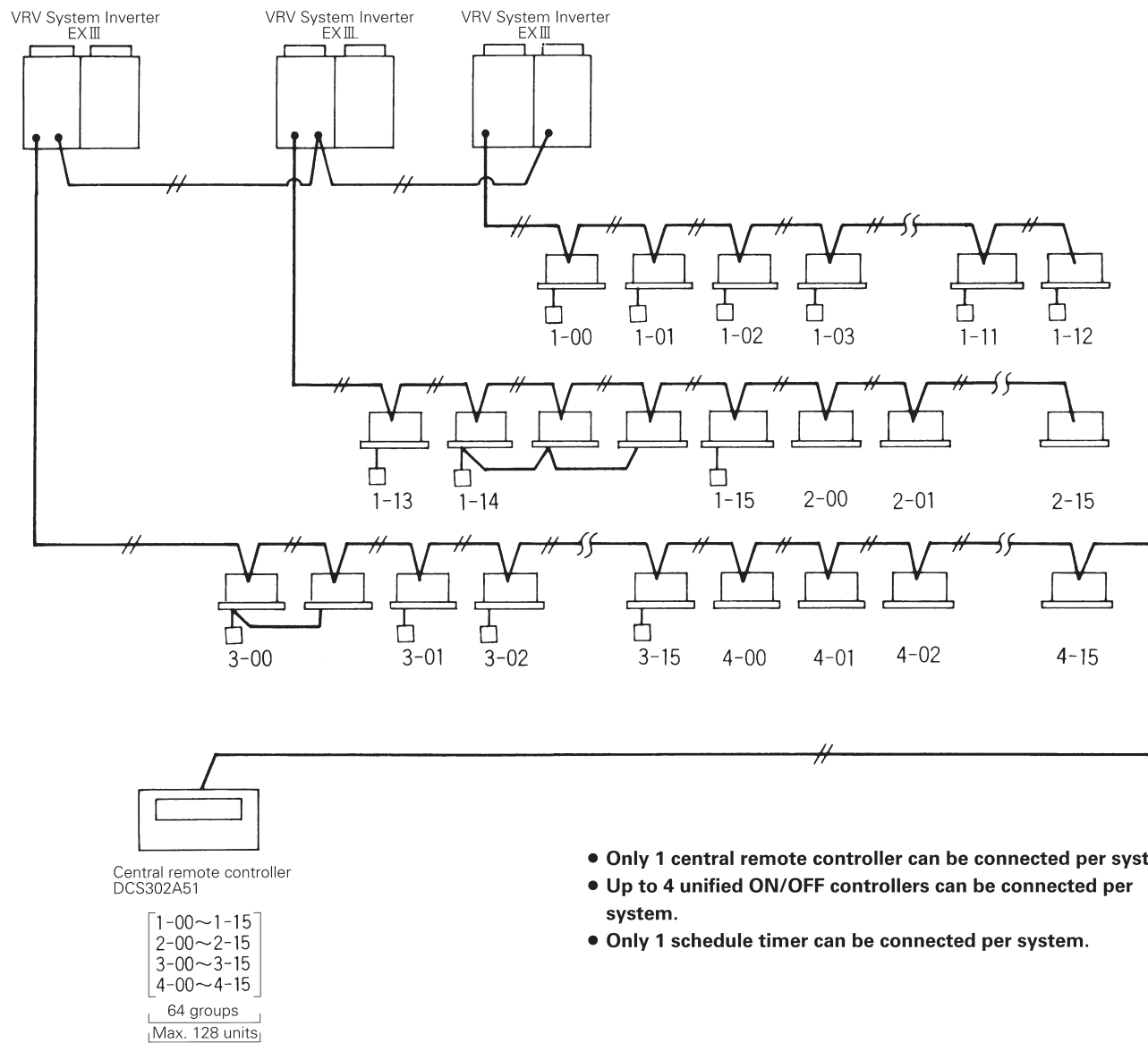



■ **When using model B centralized control device**

- Up to 128 indoor units can be connected within a system. (Group control is not required to increase the number of units that can be connected within the system.)
- When double remote controllers are connected, the same indoor unit cannot be registered for more than one central remote controller.

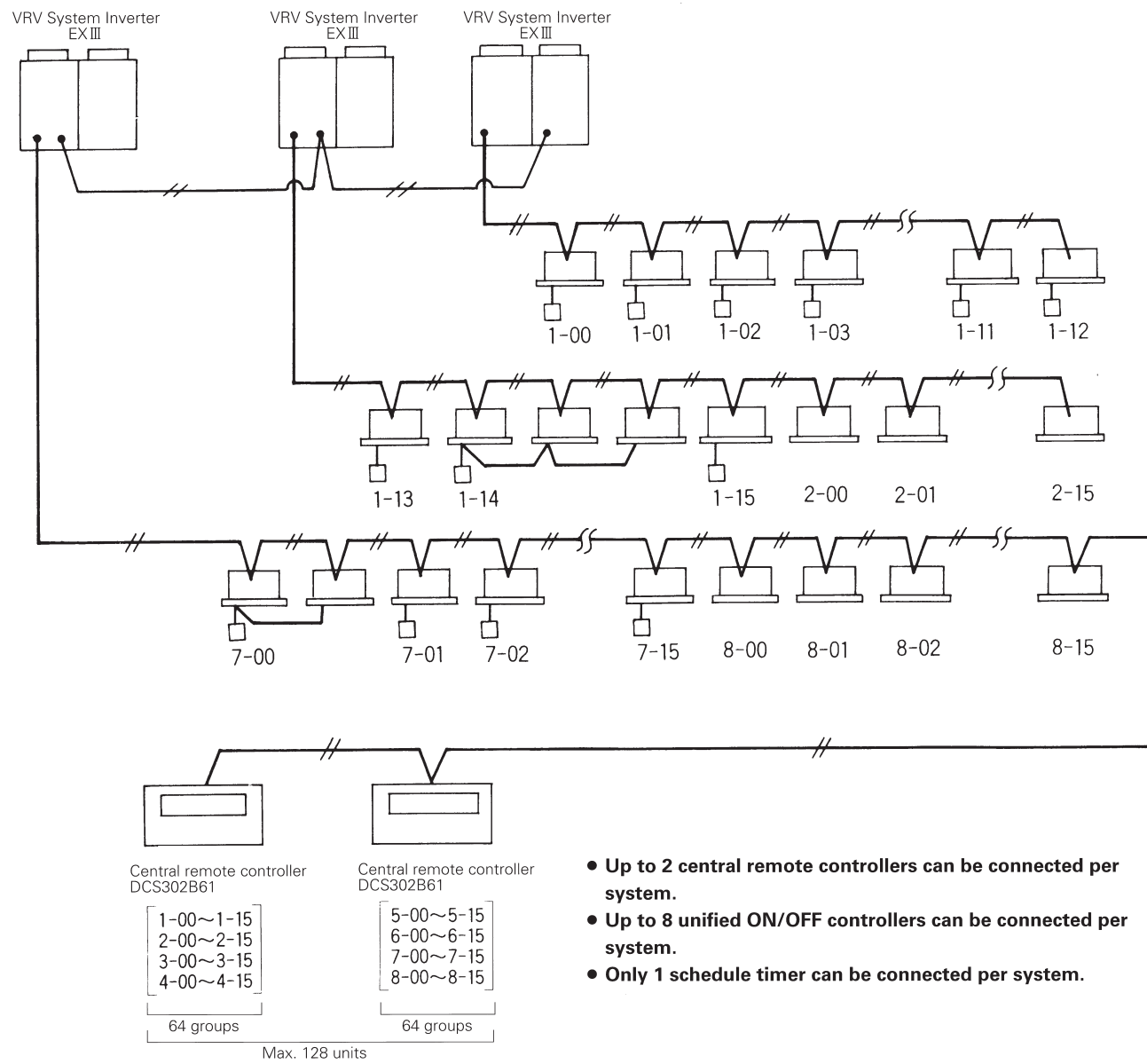

Все каталоги и инструкции здесь: <https://splitssystema48.ru/instrukcii-po-ekspluatatsii-kondicionerov.html>



19. Central Remote Controller (DCS302A51 / DCS302B61)

Enables central control with the performance of a series of remote controllers by connecting with up to 64 groups of indoor units (128 units).

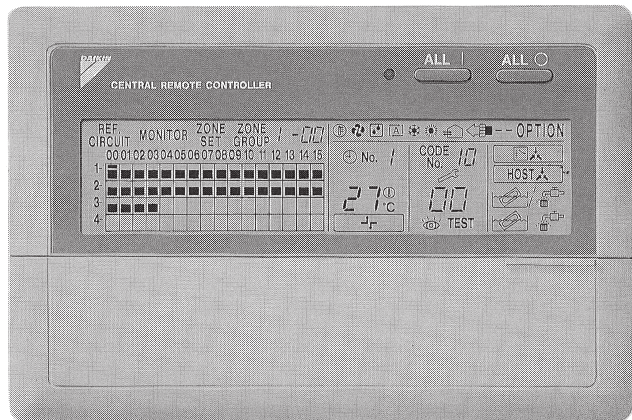

- You can connect with up to 64 groups of indoor units (128 units) and monitor or perform operations such as turning on/off individually or simultaneously, setting temperature, etc., by the zone.
- Designed to save labor of operation, and is able to execute zone control for up to 64 zones.
- Malfunction contents are given in code, so maintenance or inspection can be carried out quickly.
- Lets you connect 1 schedule timer and 4 unified ON/OFF controllers per central remote controller, and enables you to freely expand the central control system in accordance with scale and use.
- Wiring can be extended up to 1 km. Besides crossover wiring, bus or star type can also be used.
- Can be used in combination with other D-BACS equipment and allows input from outside of forced OFF, etc.
- Enables individual on/off and monitoring of total heat exchanger units (HRV) (model B Series and multifunction type).

■ System Configuration

With a central remote controller, you can simultaneously turn up to 64 groups of indoor units on or off (up to 128 units). You can also turn on or off, set operation and control modes such as operation controlled by timer, make operation by remote controller possible or impossible, and control or display operation conditions such as preset temperature by zone. (Case where operation controlled by timer is used in combination with schedule timer.) By group, you can display operation conditions such as operation mode and preset temperature. Connection by forced OFF input (non-voltage a contact) with outside key system or host computer monitor panel is impossible.

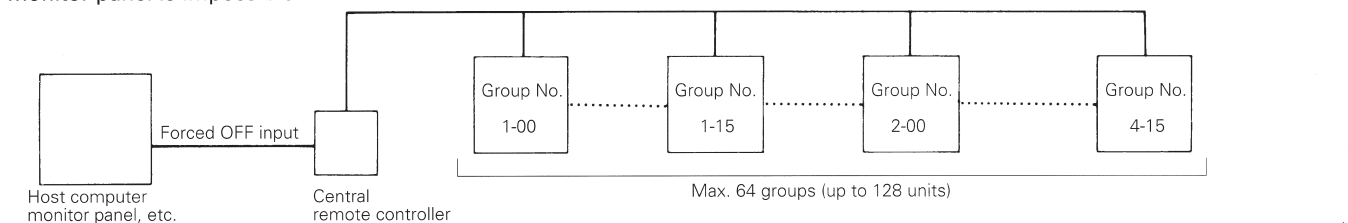

(This optional accessory cannot be used in combination with optional accessory wiring adaptor KRP4A53 or KRP2A61, 62 for electrical appendices.)
A group of indoor units is as described below.

(1) 1 indoor unit with no remote controller



(2) 1 indoor unit controlled by either 1 or 2 remote controllers

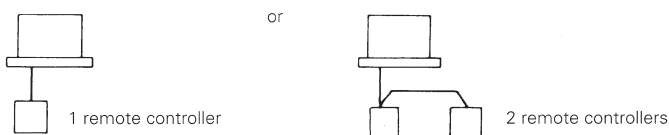

(3) Max. 16 indoor units controlled by either 1 or 2 remote controllers

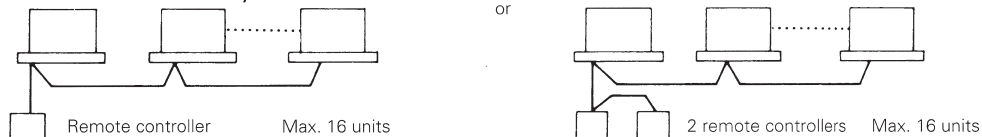

• **Zone control by central remote controller (A "zone" is a collection of 1 or more groups.)**

• Zone control lets you make settings for several groups simultaneously in order to facilitate the task of setting.

By setting once, everything in the zone becomes set to the same setting. The number of zones that can be set by the central remote controller is MINI-MAX 64 zones. (The number of groups in 1 zone is MINI-MAX 64 groups.) The manner of linking zones can be set as desired with the central remote controller.

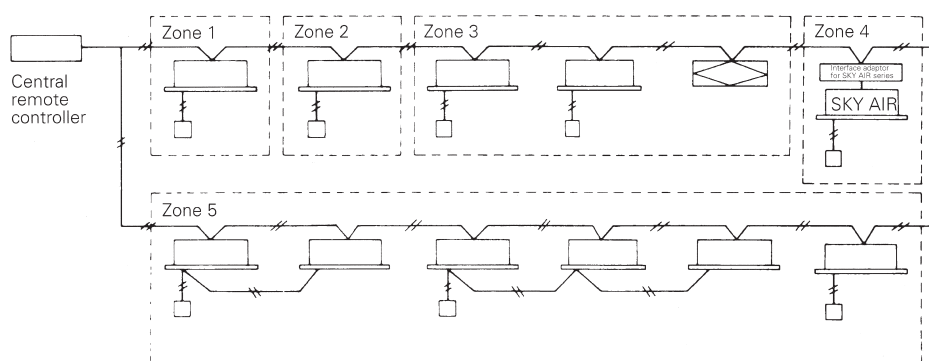

Все каталоги и инструкции здесь: <https://splitssystema48.ru/instrukcii-po-ekspluatatsii-kondicionerov.html>



Central remote controller part names and functions

- Display section (All items in the display are lit for the purpose of explanation, contrary to when actually operating.)

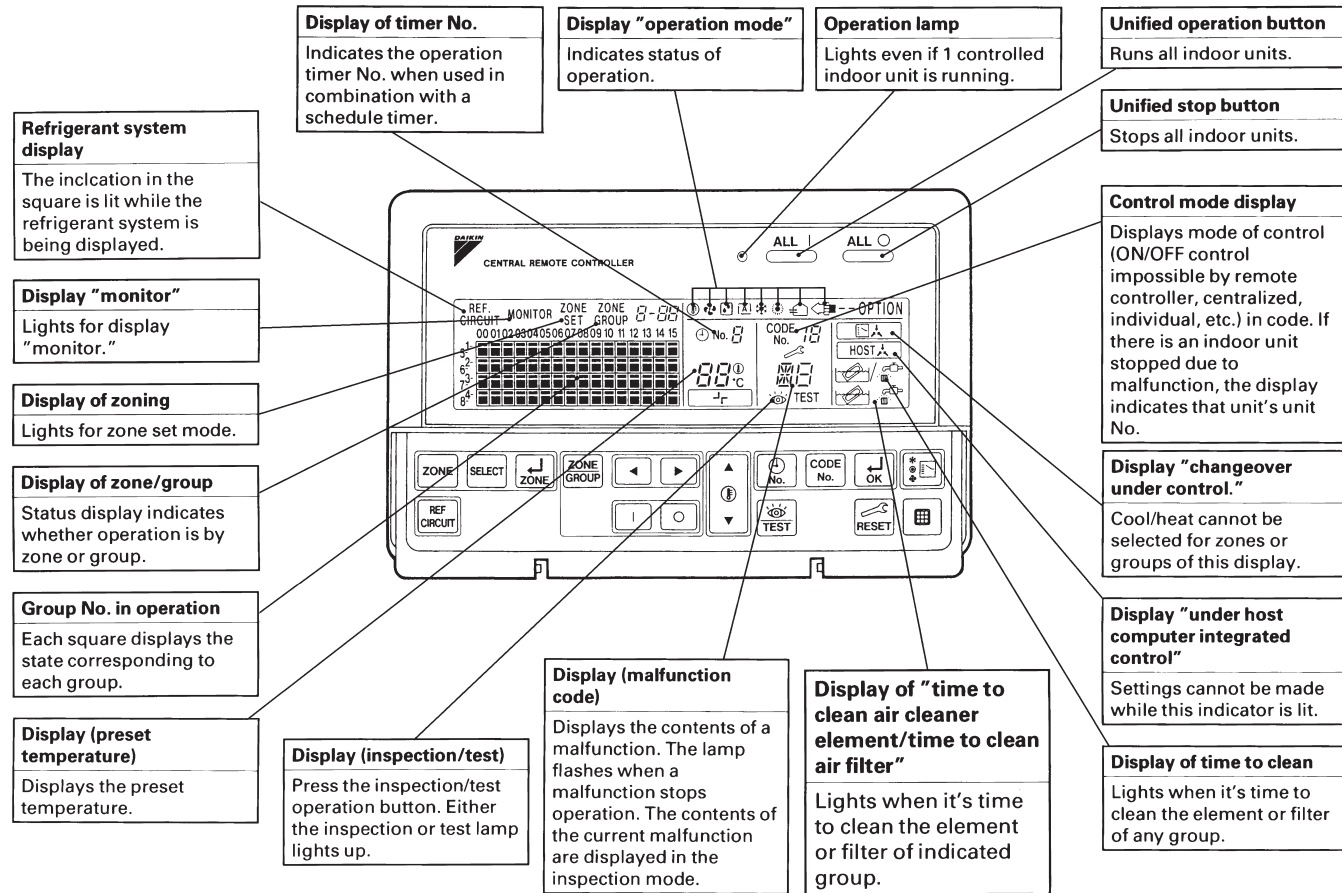

- Control Section

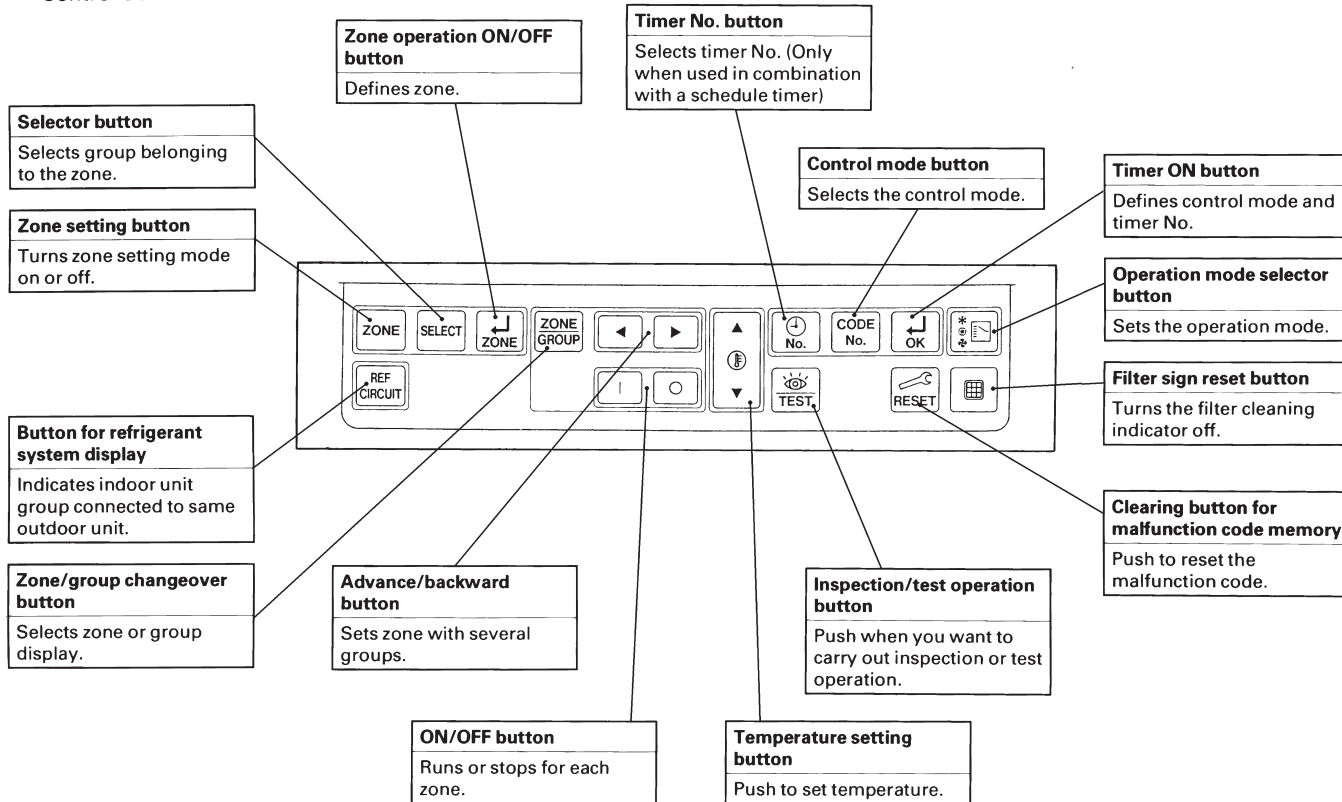

Все каталоги и инструкции здесь: <https://splitssystema48.ru/instrukcii-po-ekspluatatsii-kondicionerov.html>





Control wiring

Wiring outline

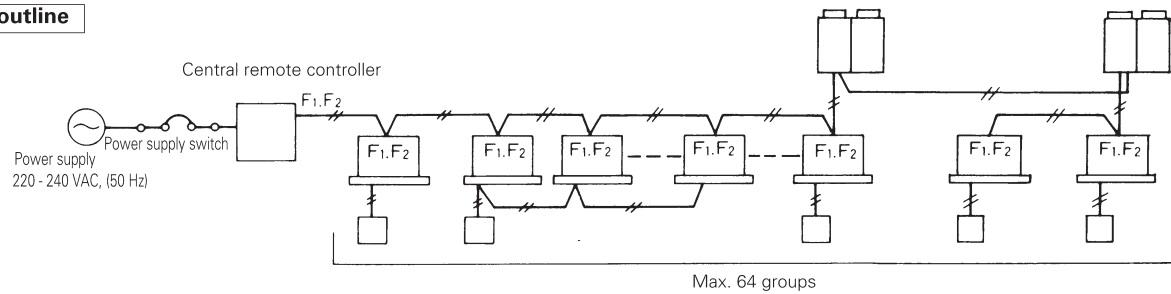

Wiring specs.

Power supply wiring	2 mm ²
Transmission wiring for control	0.75 ~ 1.25 mm ² sheathed vinyl cord or cable (double core); max. extension 1000 m (total wiring length 2000 m)
Power supply switch	10A

Control wiring connection example (Indoor units in same system shown in the following examples.)

(1) series wiring

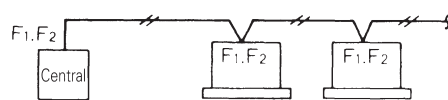

Central : Central remote controller

Indoor unit

Terminal block (field supplied part)

(2) Bus wiring (can be branched in max. 16 locations) Example showing 3 branches

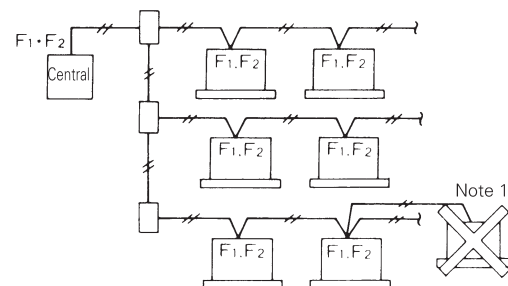

(3) Star wiring (can be branched in max. 16 locations) Example showing 3 branches

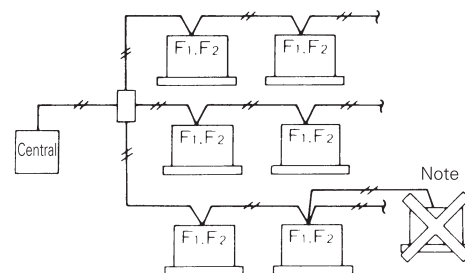

Notes) 1. Cannot be branched again after being branched once.

2. Use a junction terminal block if branching 3 or more control wires from the same terminal block.

3. Do not connect transmission wiring between indoor and outdoor units of different refrigerant circuits.

Wiring to indoor units

The terminals (F1, F2) of the control terminal block of the central remote controller and the terminals (F1, F2) of indoor units for which a group No. has been set are wired as shown in the figure below. (There is no polarity, so it doesn't matter if F1 and F2 are wired inversely.)

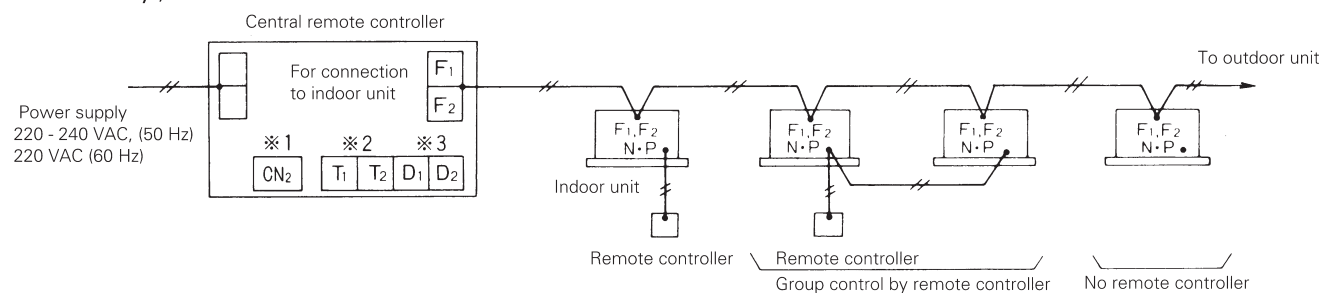

※1. Connector for unification adaptor for computerized control (CN2)

※2. Forced OFF input (T1, T2)

Forced OFF input (no-voltage contact for micro-current) turns off all indoor units while the contact is "closed." Use a contact which guarantees min. applicable load of 16VDC, 10 mA.

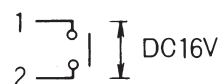

※3. Power supply for schedule timer (D1, D2)

Все каталоги и инструкции здесь: <https://splitsystem48.ru/instrukcii-po-ekspluatatsii-kondicionerov.html>





■ Contents of control modes

Twenty modes consisting of combinations of the following five operation modes with temperature and operation mode setting by remote controller can be set and displayed by operation modes 0 through 19.

- ON/OFF control impossible by remote controller
Used when you want to turn on/off by central remote controller only.
(Cannot be turned on/off by remote controller.)
- OFF control only possible by remote controller
Used when you want to turn on by central remote controller only, and off by remote controller only.
- Centralized
Used when you want to turn on by central remote controller only, and turn on/off freely by remote controller during set time.
- Individual
Used when you want to turn on/off by both central remote controller and remote controller.
- Timer operation possible by remote controller
Used when you want to turn on/off by remote controller during set time and you do not want to start operation by central remote controller when time of system start is programmed.
- The operation modes are from 0 through 19, however, they can only be set for outdoor units (VRV System inverter K Series) for which cool/heat can be selected by indoor unit. With the exception of this, settings are 0 through 9.

How to select operation mode

- Whether operation by remote controller will be possible or not for turning on/off, controlling temperature or setting operation mode is selected and decided by the operation mode given on the right edge of the table below.

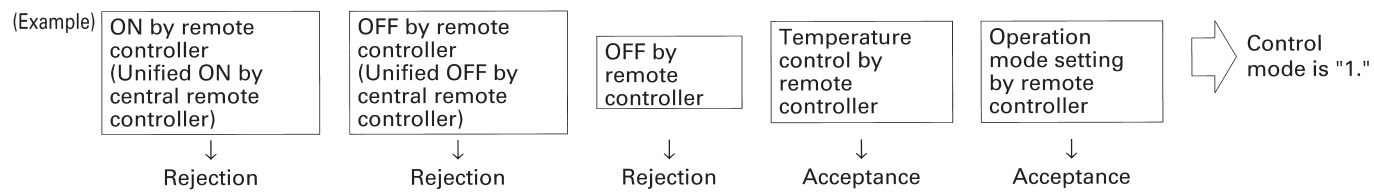

Control mode	Control by remote controller					Control mode	
	Operation		OFF	Temperature control	Operation mode setting		
	Unified operation, individual operation by central remote controller, or operation controlled by timer	Unified OFF, individual stop by central remote controller, or timer stop					
ON/OFF control impossible by remote controller	Rejection (Example)	Rejection (Example)	Rejection (Example)	Rejection	Acceptance	0	
OFF control only possible by remote controller			Acceptance (Example)	Acceptance (Example)	Acceptance (Example)	Rejection	1 (Example)
Centralized	Acceptance	Acceptance	Acceptance	Rejection	Acceptance	2	
Individual				Acceptance	Rejection	Acceptance	3
				Acceptance	Acceptance	Rejection	4
Timer operation possible by remote controller				Acceptance (During timer at ON position only)	Acceptance (During timer at ON position only)	Rejection	Acceptance
			Acceptance	Rejection	6	15	
			Rejection	Acceptance	7	16	
			Acceptance	Rejection	8	17	
			Rejection	Acceptance	9	18	
			Acceptance	Rejection	10	19	

Do not select "timer operation possible by remote controller" if not using a remote controller. Operation by timer is impossible in this case.

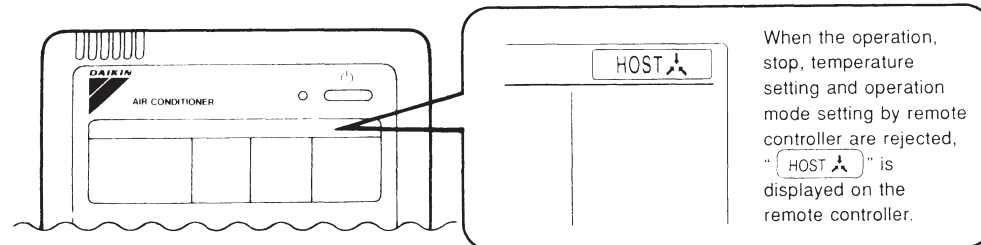



20. Unified ON/OFF Controller (DCS301A51/ DCS301B61)

Turns each group of indoor units on/off individually or simultaneously for up to 16 groups (128 units), and lets you check the operation/malfunction display all at once at a glance.

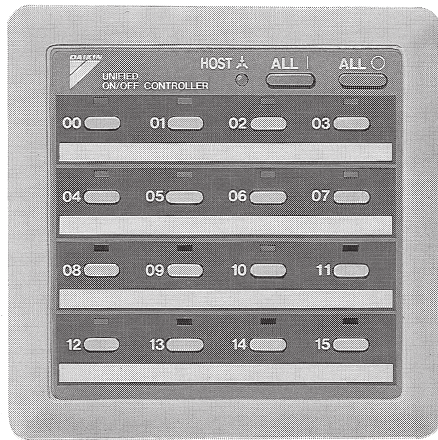

- Lets you turn up to 16 groups of indoor units (128 units) on/off simultaneously or individually, and lets you check the operation/malfunction display all at once at a glance.
- By combining with a central remote controller or schedule timer, you can build a system that matches scale and use .
- Features compact size casing with thickness of only 16 mm. (Uses JIS recessed box for 2)
- Wiring can be extended up to 1 km. For the wiring method, bus type and star type wiring crossover wiring can be used as well as crossover wiring.
- Can be used in combination with other D-BACS equipment.

■ System configuration

Up to 16 groups of indoor units can be turned on/off individually or simultaneously by unified ON/OFF controller. Also lets you connect with an outside key system or host computer monitor panel by forced OFF input (no-voltage a contact).

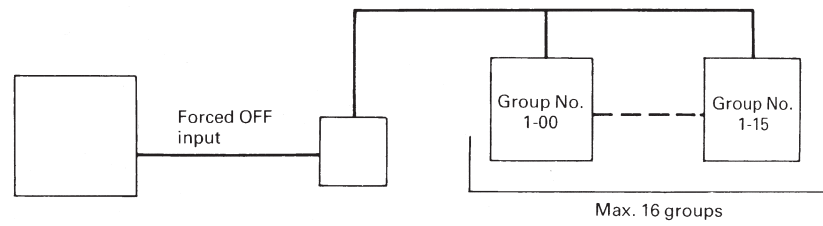

(This optional accessory cannot be used in combination with optional accessory wiring adaptor for electrical appendices.)

A group of indoor units is as described below.

(1) 1 indoor unit with no remote controller



No remote controller

NOTE: If not using remote controllers, use in combination with central remote controller.

(2) 1 indoor unit controlled by either 1 or 2 remote controllers

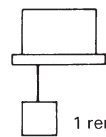

1 remote controller

or

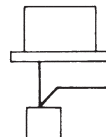

2 remote controllers

(3) Max. 16 indoor units group-controlled by either 1 or 2 remote controllers

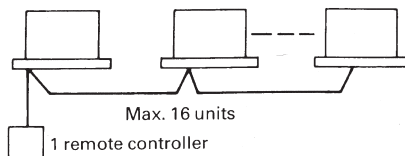

Max. 16 units
1 remote controller

or

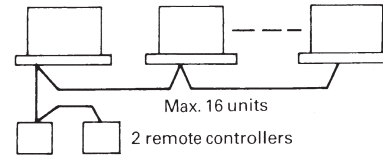

Max. 16 units
2 remote controllers

Все каталоги и инструкции здесь: <https://splitssystema48.ru/instrukcii-po-ekspluatatsii-kondicionerov.html>



■ Wiring for transmission

Wiring outline

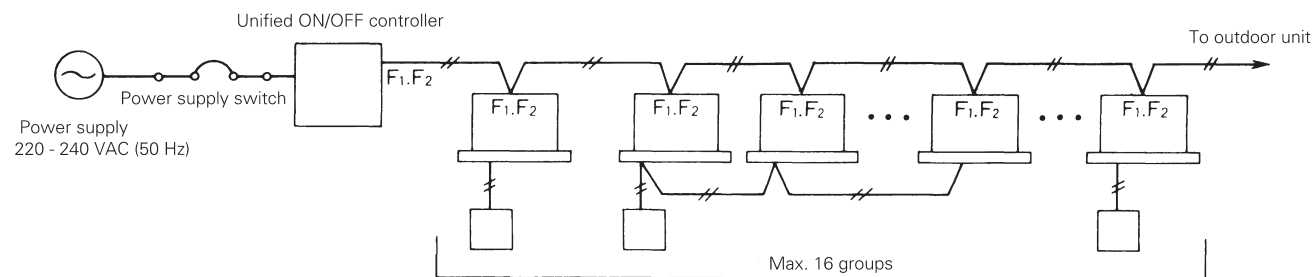

Wiring specifications

Power supply wiring	2 mm ²
Wiring for transmission	0.75 ~ 1.25 mm ² sheathed vinyl cord or cable (double core); max. extension 1000 m (total wiring length 2000 m)
Power supply switch	10A

Connection example of wiring for transmission

(1)series wiring, (2)bus type wiring and (3)star type wiring are the same as with a central remote controller.

Wiring for indoor unit

Terminals F1 and F2 of the unified ON/OFF controller's terminal block for control and terminals F1 and F2 of the indoor unit with set group No. are wired as shown in the figure below. (There is no polarity, so it doesn't matter if F1 and F2 are inverted.)

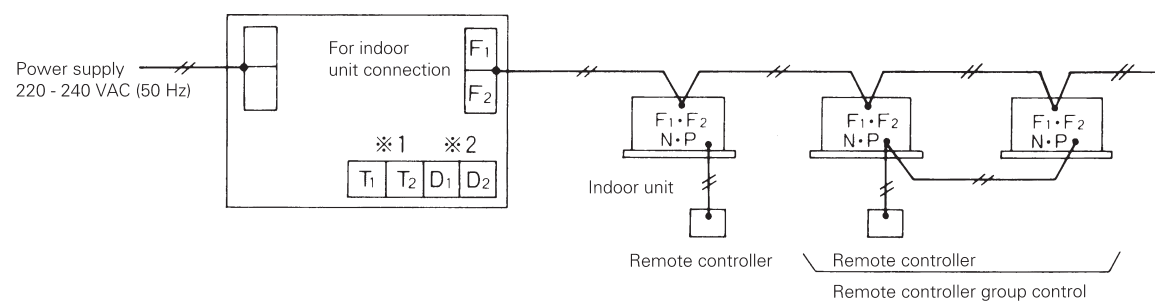

※1: Forced OFF input (T1, T2)

All connected indoor units go off and do not run while forced OFF input (for no-voltage contact, micro-current) is "closed." Use a contact that can guarantee a 16 VDC, 10 mA minimum applicable load.

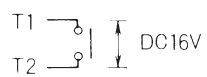

NOTE: If using an instantaneous contactor, use one that handles conducting time of 200 msec or more.

※2: Power supply for schedule timer (D1, D2)

※Wire only if 1, 2 and 3 are used.

21. Schedule Timer (DST301A51 / DST301B61)

Allows you to connect and manage by unified control the weekly schedule of up to 128 indoor units.

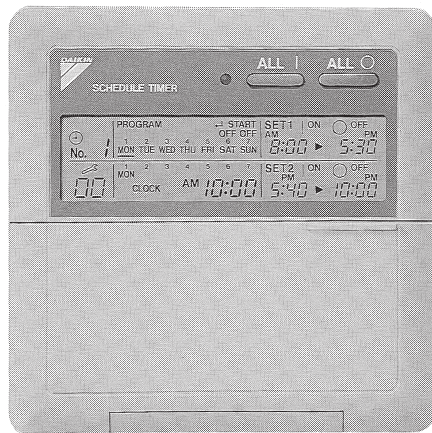

- Manages by unified control the weekly schedule of up to 128 indoor units.
- Lets you set in 1-minute increments on/off time twice a day by the week.
- By combining with a central remote controller or unified ON/OFF controller, you can build a system that matches scale and use.
- When using in combination with a central remote controller, you can set up to eight weekly schedule patterns and distribute among zones by central remote controller as desired.
- Equipped with a power failure compensation function effective for up to 48 hours.
- Features compact size casing with thickness of only 16 mm. (Uses JIS recessed box for 2)
- Wiring can be extended up to 1 km. For the wiring method, bus type and star type wiring crossover wiring can be used as well as crossover wiring.
- Can be used in combination with other D-BACS equipment.

■ System configuration and electrical wiring

With a schedule timer, you can program the time units will be turned on/off simultaneously for periods of one week each for up to 16 groups of indoor units.

- System configuration

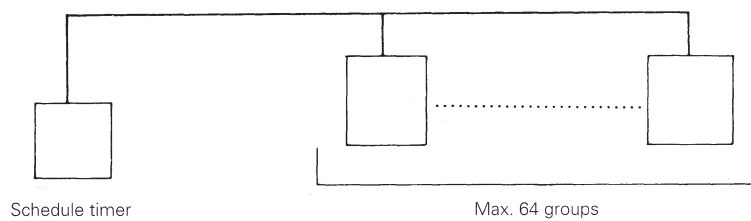

If using the schedule timer individually, you don't have to set the group No. setting for centralized control for group unified control.

- Wiring for transmission

Indoor unit wiring

(1) If schedule timer individual use:

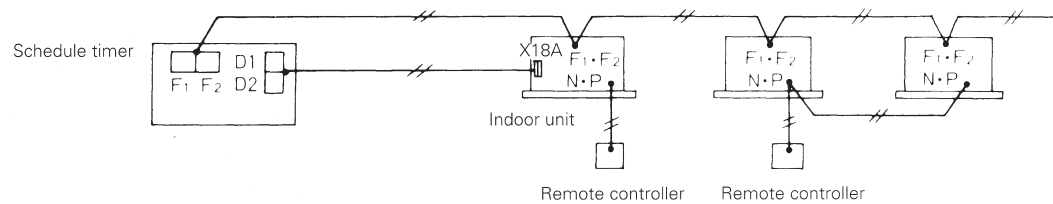

- For the schedule timer's power supply, connect the schedule timer's connectors (D1/D2) and the connector on the indoor unit's PC board (CN18) with the attached cable and crimp style terminals.

(2) If using in combination with other optional controllers for centralized control:

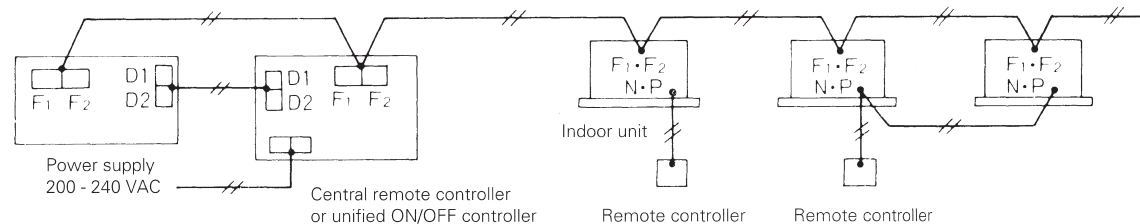

Wiring for transmission: 0.75 ~ 1.25 mm² sheathed vinyl cord or cable (double core)...Max. extension 1000 m (Total wiring length 2000 m)

Connection example of wiring for transmission

(1) series wiring, (2) bus type wiring and (3) star type wiring are the same as with a central remote controller.



■ Schedule timer part names and functions

- Display section (All items in the display are lit for the purpose of explanation, contrary to when actually operating.)

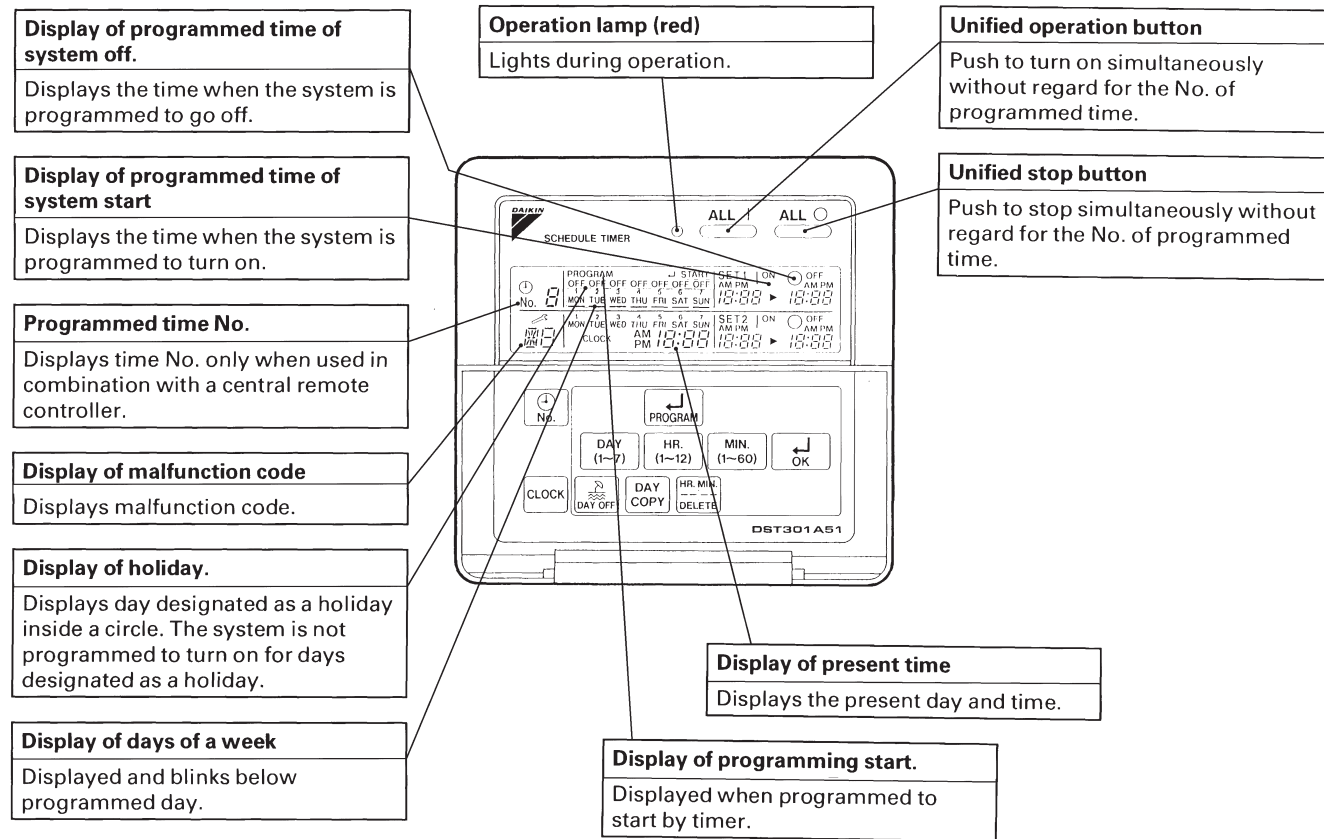

- Control section

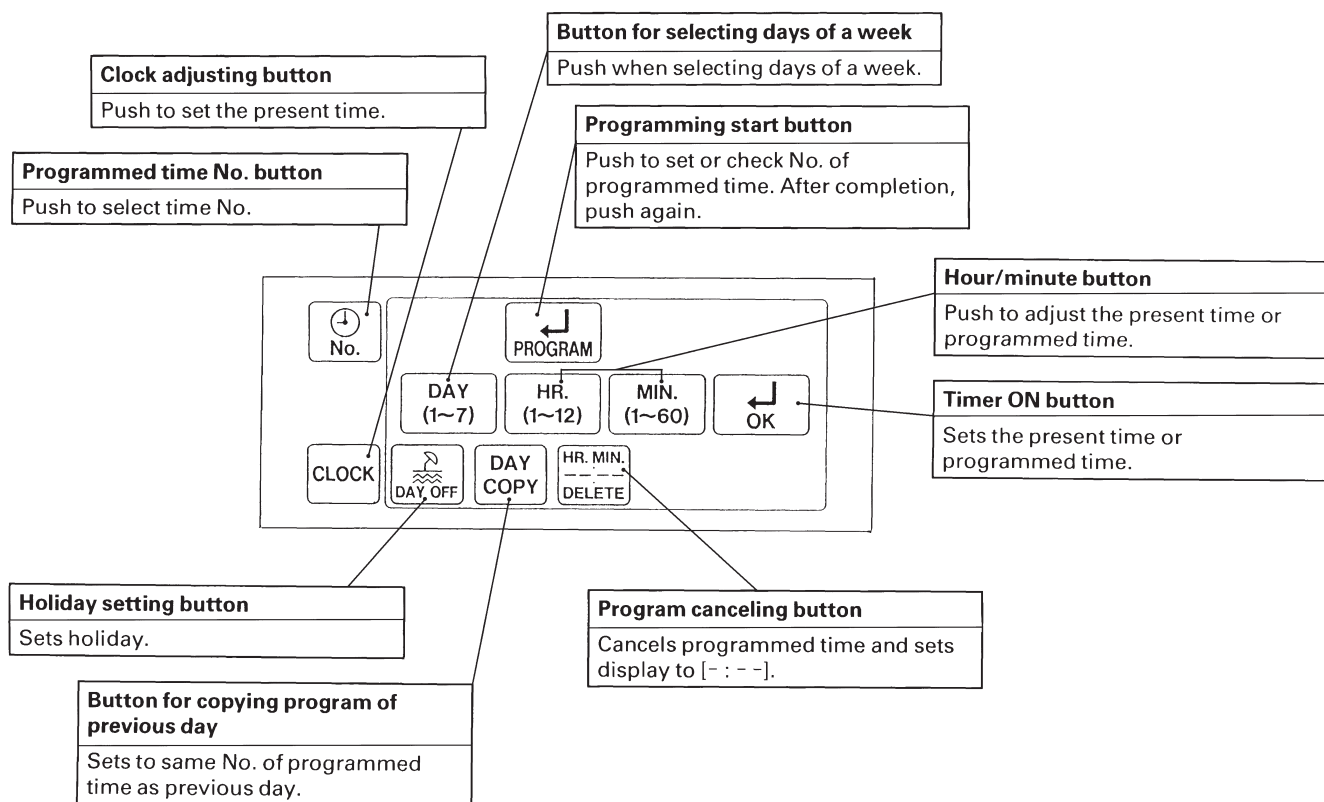

Все каталоги и инструкции здесь: <https://splitsystem48.ru/instrukcii-po-ekspluatatsii-kondicionerov.html>



22. Combining Different Types of Centralized Control Devices

<DCS302A51 · DCS301A51 · DST301A51>

<DCS302B61 · DCS301B61 · DST301B61>

In addition to using optional controllers for centralized control independently, you also combine and connect a schedule timer and unified ON/OFF controller with a central remote controller. By designing with components, you can construct the best central remote control system for your purpose and scale.

■ Example of DCS302A51 / DCS301A51/ DST301A51 Systems

● Unified ON/OFF controller

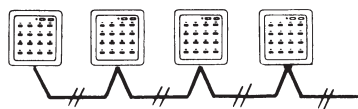

Unified ON/OFF controllers are connected in accordance with the number of indoor units. A single line network can contain up to 16 groups of four units each.

● Schedule timer plus central remote controller

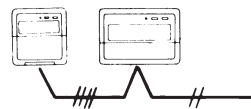

Allows you to set up to eight weekly schedules for turning units ON/OFF twice each day. Enables scheduled operation of up to 64 groups of indoor units individually or by zone.

● Central remote controller plus unified ON/OFF controller

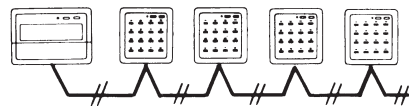

Combines the functionality of a central remote controller with the operability of a unified ON/OFF controller. Enables central control of up to 64 groups of indoor units.

● Schedule timer plus unified ON/OFF controller

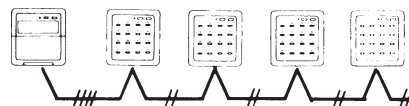

Allows you to set the time for turning units ON/OFF twice each day. Enables unified scheduled operation of up to 64 groups of indoor units.

■ Connection for optional controller for centralized control

You can use any combination of one central remote controller, one schedule timer, and from one to four unified ON/OFF controllers. If using the model B Series, you can use any combination of two central remote controller, one schedule timer, and from one to eight unified ON/OFF controllers. The maximum number of units for a single system is 128 for both model A and B.

Central remote controller DCS302A51/B61	Unified ON/OFF remote controller DCS301A51/B61	Schedule timer DST301A51/B61
1	—	—
1	1	—
1	2 ~ 4	—
1	—	1
1	1	1
1	2 ~ 4	1
—	1	—
—	2 ~ 4	—
—	1	1
—	2 ~ 4	1
—	—	1

Central remote controller DCS302B61	Unified ON/OFF remote controller DCS301B61	Schedule timer DST301B61
2	—	—
2	1	—
2	2 ~ 8	—
2	—	1
2	1	1
2	2 ~ 8	1
—	1	—
—	2 ~ 8	—
—	1	1
—	2 ~ 8	1
—	—	1

Все каталоги и инструкции здесь: <https://splitssystema48.ru/instrukcii-po-ekspluatatsii-kondicionerov.html>



Electric wiring

(Combination of one central remote controller, one schedule timer and three unified ON/OFF controllers)

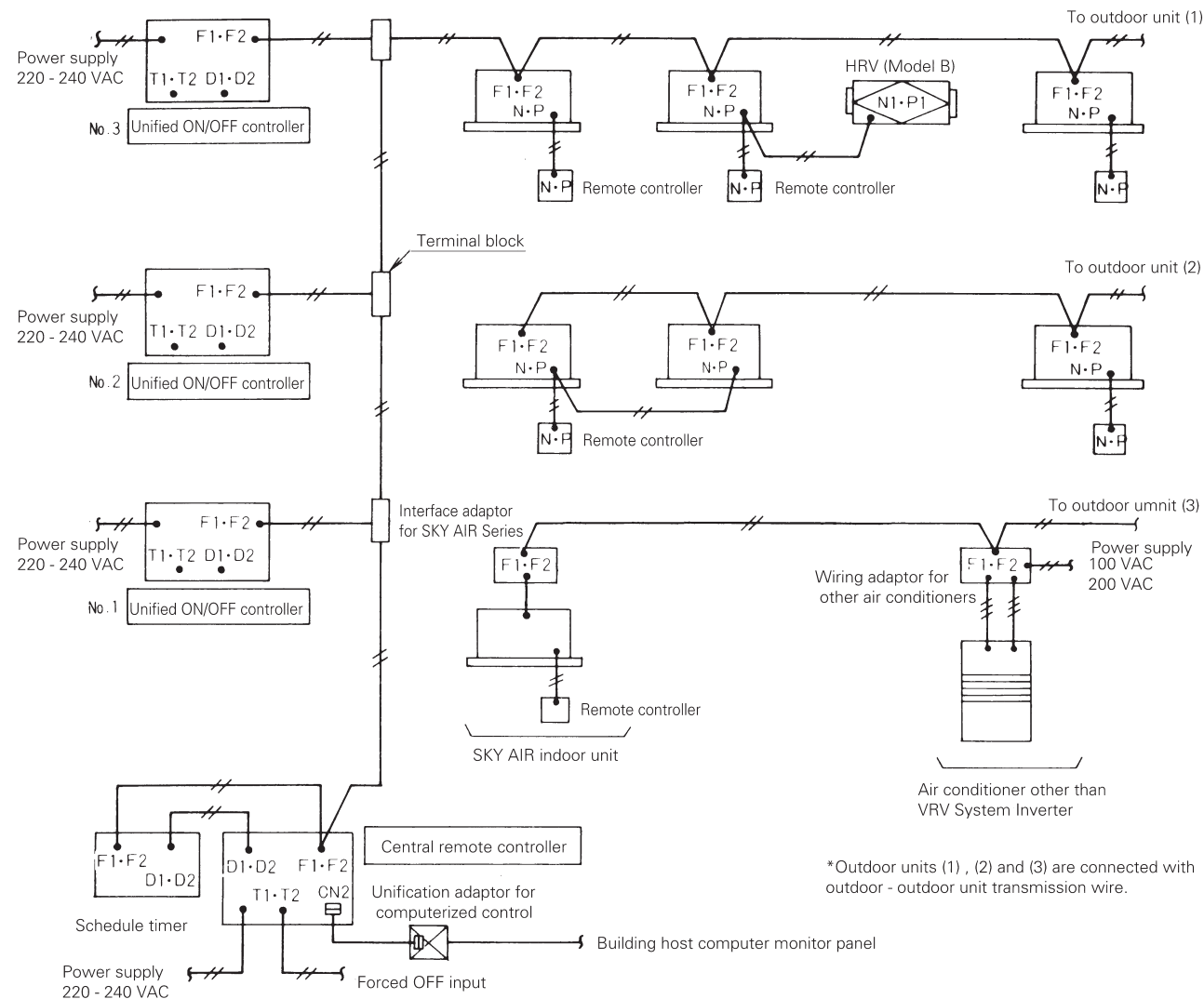

*Outdoor units (1), (2) and (3) are connected with outdoor - outdoor unit transmission wire.

Initial settings of optional controllers for centralized control

(1) Central remote controller

- Leave the connector for setting master controller (CN) connected. (Connected at factory set.)
Connect this connector to one central control line only.
- Control mode
Sets priority sequence for control of central remote controller and indoor unit remote controllers.
- Zone setting
Sets zone for controlling several groups within the same zone.

(2) Unified ON/OFF controller (No. 1, No. 2, No. 3 in figure above)

- Disconnect the connector for setting master controller (X1A).
- Switch for setting each address (DS1)
Sets the group No. address for each group of indoor units controlled by unified ON/OFF controller No. 1, No. 2 and No. 3 in the figure above. You can set 16 units (16 groups) for one unified ON/OFF controller.
- Control mode switch (DS2)
Sets priority sequence for control of central remote controller and indoor unit remote controllers. If used together with a central remote controller, however, the central remote controller's control mode has priority.

(3) Schedule timer

- Leave the connector for setting master controller (X1A) disconnected. (Factory set)
- Control mode switch (SS2)
Sets priority sequence for control of schedule timer and indoor unit remote controllers. If used together with a central remote controller, however, the central remote controller's control mode has priority.

Group No. setting centralized control

(1) Set by indoor unit remote controller

- Sets group No. by remote controller in the field set mode. (Group No. are 1 - 00 ~ 1 - 15, 2 - 00 ~ 2 - 15,4 - 00 ~ 4 - 15.....)

(2) Setting by PC board adaptor

- If using an interface adaptor for SKY AIR Series or wiring adaptor for other air conditioners, set the centralized control group No. with group No. setting switches RS1 and RS2 on the PC board.
1 ~ 4 for RS1 (upper)
(1 ~ 8 for interface adaptor for SKY AIR Series)
0 ~ F for RS2 (lower)





MEMO



Все каталоги и инструкции здесь: <https://splitssystema48.ru/instrukcii-po-ekspluatácii-kondicionerov.html>





TROUBLESHOOTING

Inverter K series



Все каталоги и инструкции здесь: <https://splitssystema48.ru/instrukcii-po-ekspluatatsii-kondicionerov.html>



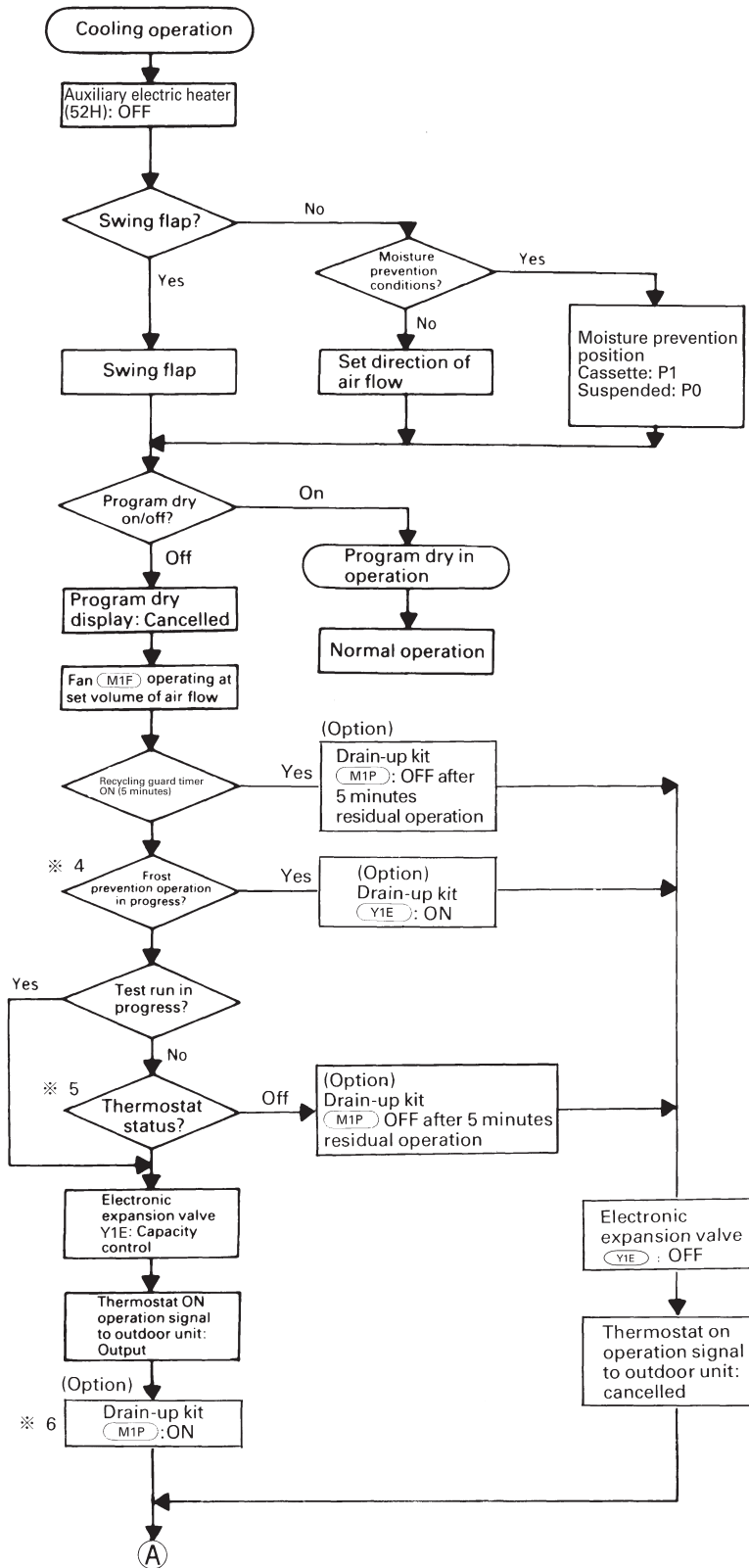

- ※ 4. If the evaporator inlet temperature is -5°C or lower, or is -1 or lower for a total of 40 minutes, frost prevention operation is initiated. Normal operation resumes when the temperature is +7°C or higher for 10 consecutive minutes.
- ※ 5. Thermostat status
- ※ 6. The drain-up kit is standard equipment for models FXYC - H, FXYE, FXYF, FXYH, FXYK and FXYS.

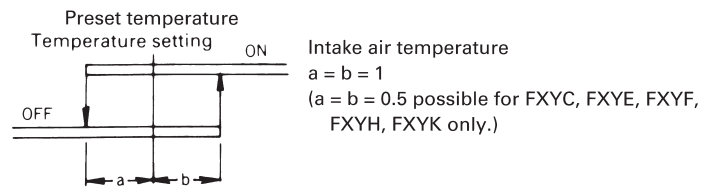

Все каталоги и инструкции здесь: <https://splitssystema48.ru/instrukcii-po-ekspluatatsii-kondicionerov.html>



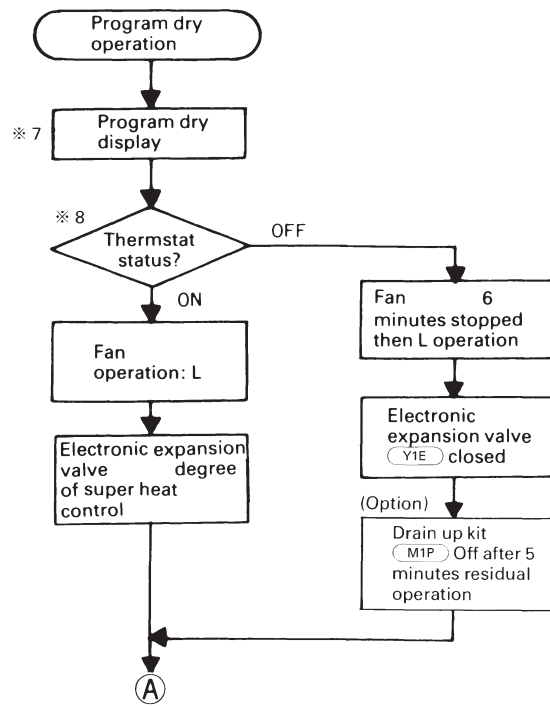

- ※ 7. Programmed dry display
Does not display preset temperature and air flow settings of the controller.
- ※ 8. Thermostat status
Preset temperature during programmed dry operation

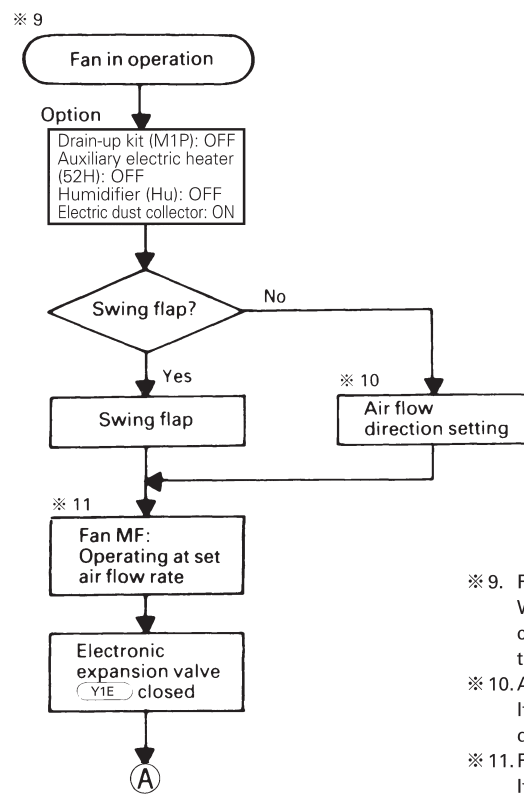
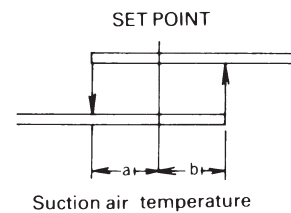

- ※ 9. Fan operation
When fan operation has been selected using the remote controller, operation is turned OFF by thermostat when temperature control operation has been selected.
- ※ 10. Air flow direction setting
If fan operation is selected with the remote controller, air discharge is 100% horizontal during heating.
- ※ 11. Fan
If fan operation is selected with the remote controller, LL speed operation is carried out during heating.



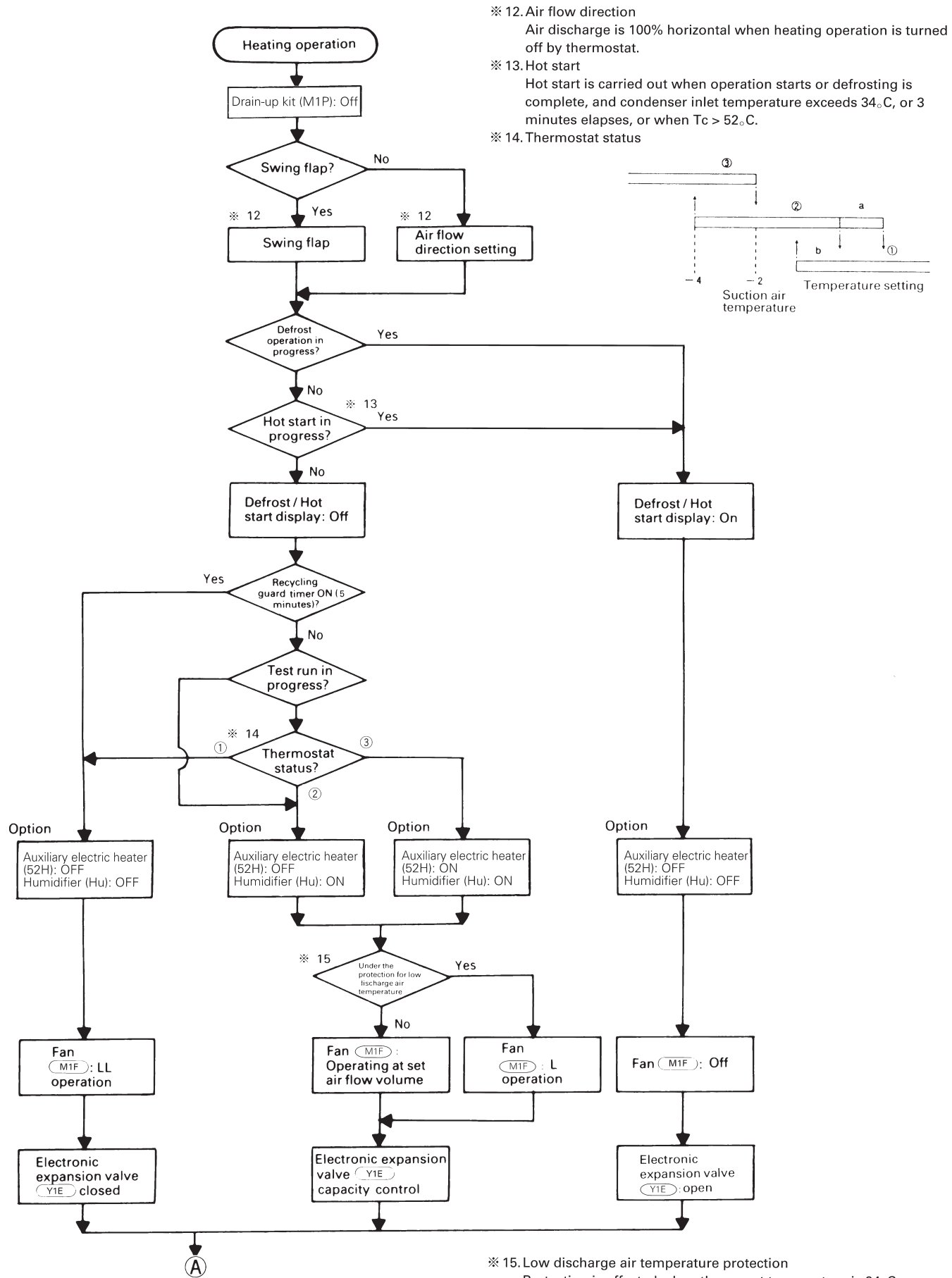

Outdoor unit operation flowchart

■ Operation flowchart

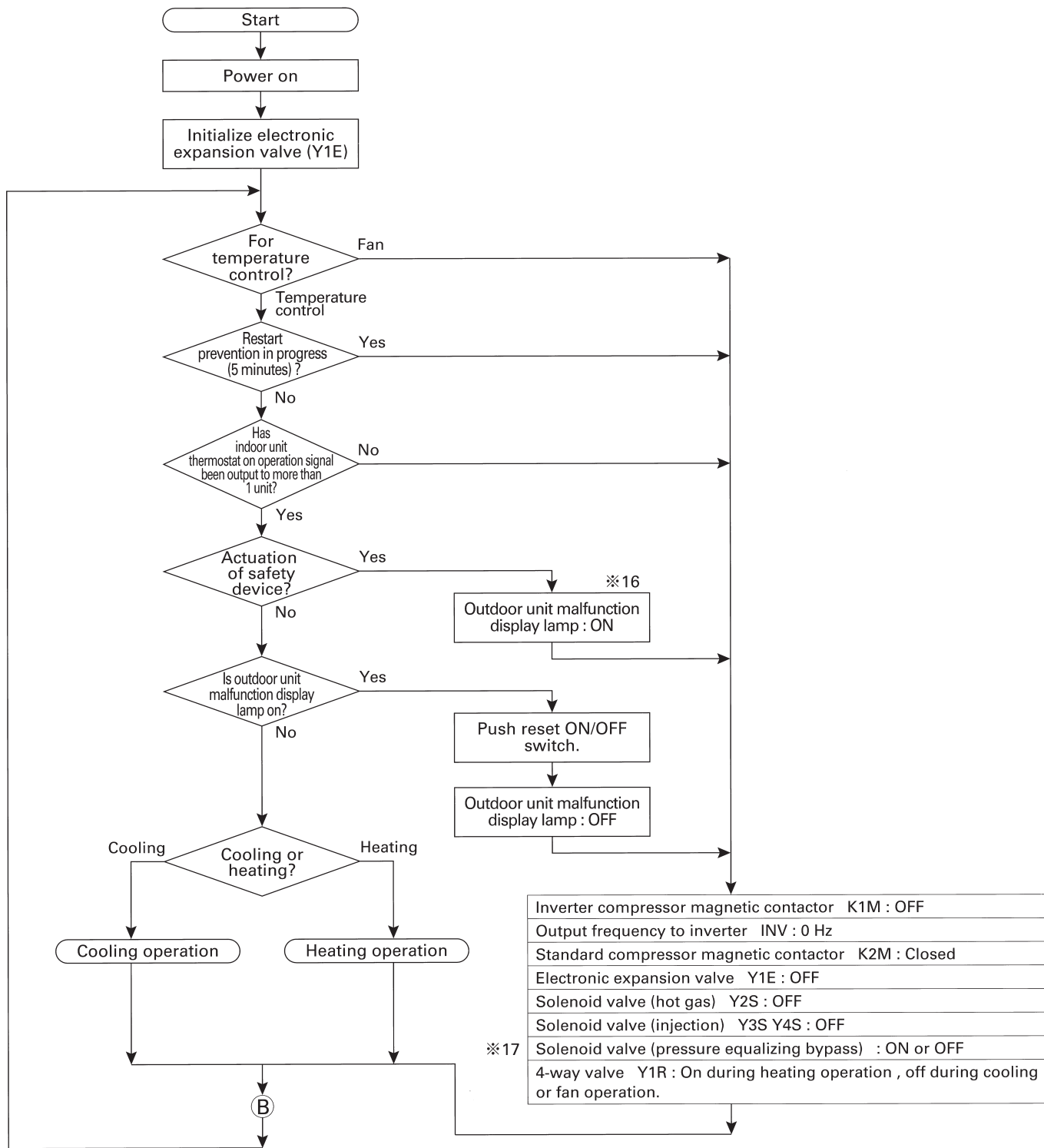

※ 16 If the outdoor unit malfunction display lamp is on then this either indicates that the outdoor unit operation has been terminated abnormally or warns that there is refrigerant shortage or else that there is a piping or wiring fault (operations will continue). (Refer to Indoor Unit Control ※1)

※ 17 ON operations restart 4 minutes after the inverter compressor has stopped.

Note: The crank case heaters (CH) are on when the magnetic relays of their respective compressors are off.

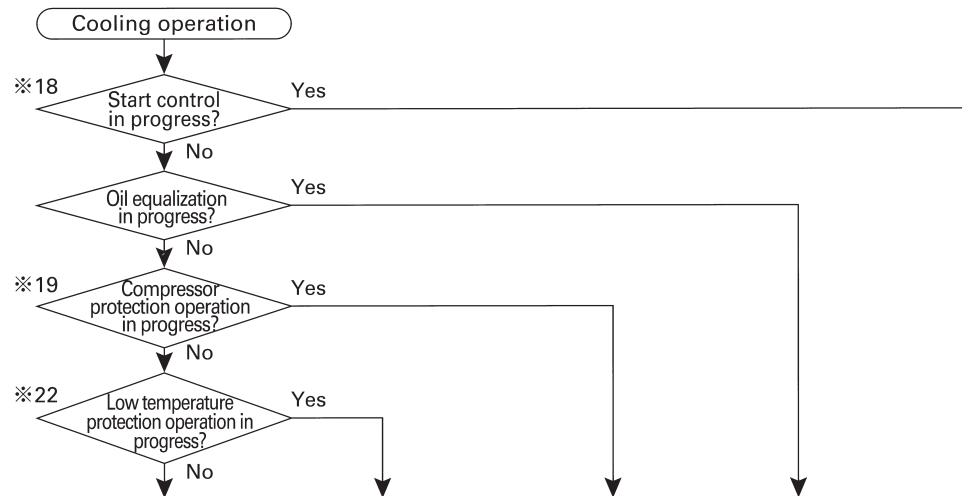

Inverter compressor magnetic contactor	K1M	ON				
Inverter output frequency	INV	30~116 Hz by P1 control ※20	30~116 Hz	30~116 Hz by P1 and protective control	38 Hz	42 Hz
Standard compressor magnetic contactor	K2M	ON/OFF by P1 control	OFF	ON/OFF by P1 and protective control	ON	OFF
Electronic expansion valve	Y1E	Open				
Solenoid valve (hot gas)	Y2S	OFF	ON/OFF by saturation temperature corresponding to suction pressure	OFF	ON	
※21 Solenoid valve (injection)	Y3S Y4S	ON/OFF by discharge temperature protection control				ON
4-way valve	Y1R	OFF				
Fan	M1F	H	※22	H		
Fan	M2F	ON		ON		

ⓑ



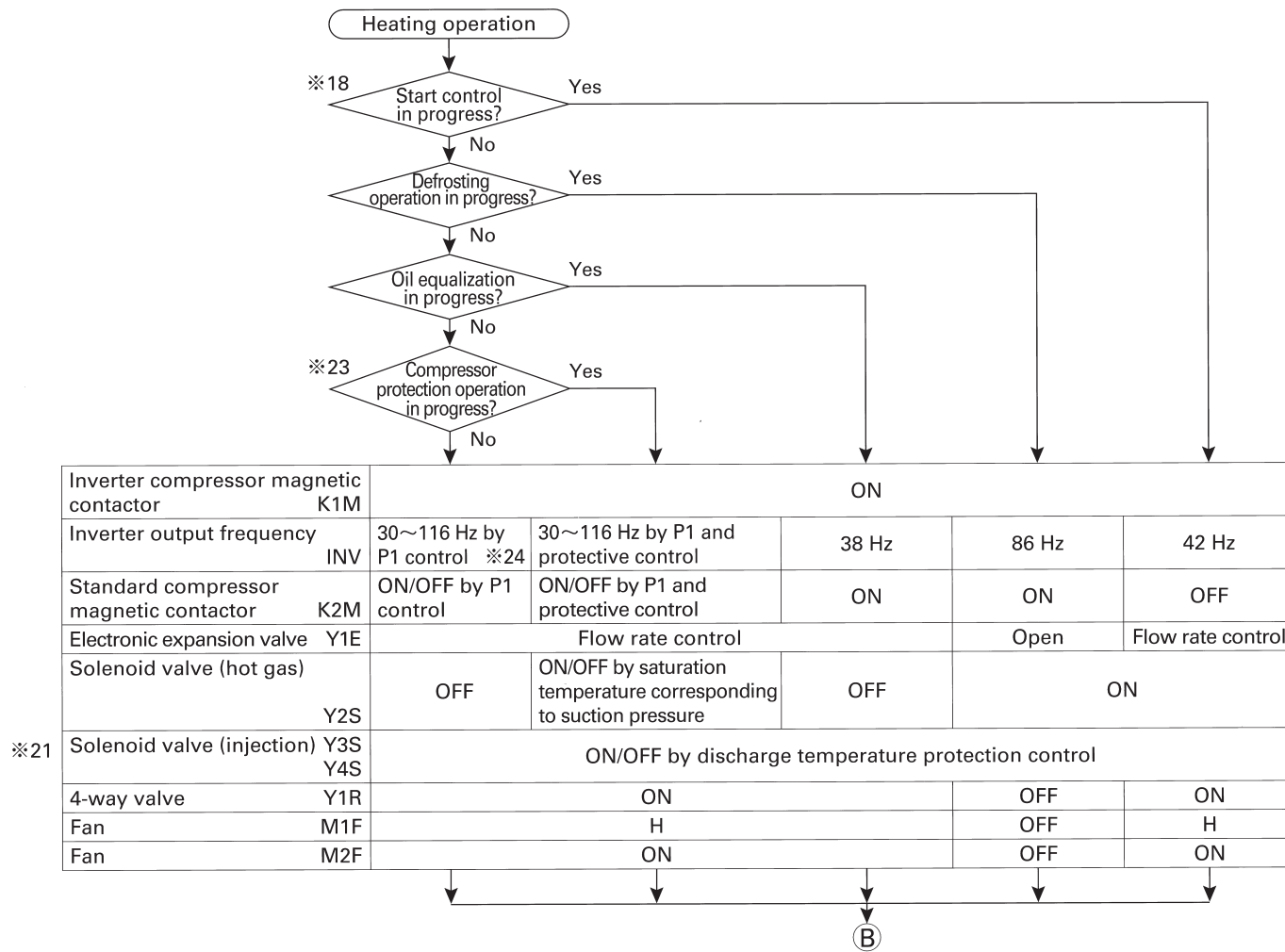

※18. Start control

60 second start control in order to prevent liquid back to the compressor.

※19. Compressor protection

1. Protection control is triggered when the cooling load is large and the saturation temperature corresponding to suction pressure is high.
2. Protection control is triggered when secondary inverter current exceeds set current.
3. Protection control is triggered by discharge temperature.
4. Protection control is triggered when saturation temperature corresponding to suction pressure is low.

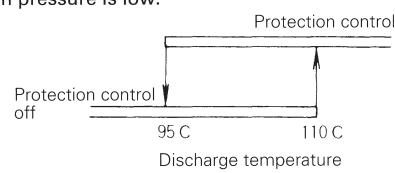

※20. P1 control

Controls ON/OFF of the standard compressor and inverter output frequency so that suction pressure is the optimal value.

※21. Discharge temperature protection

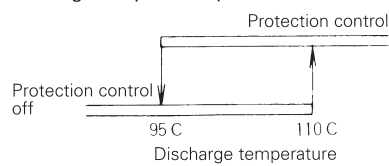

※22. Fan control during low temperature protection

If Tc is less than 26.1°C for 30 continuous seconds, fan speed changes as follows: H + ON → H + OFF → L + OFF. When Tc becomes greater than 52.4°C, fan speed returns to H + ON.

※23. Compressor protection

1. Protection control is triggered when secondary inverter current exceeds set current.
2. Protection control is triggered by discharge temperature.

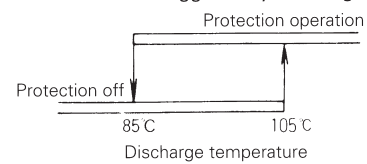

3. Protection control is triggered when the heating load is small and the saturation temperature corresponding to suction pressure is high.
4. Protection control is triggered when saturation temperature corresponding to suction pressure is low.

※24. P1 control

Controls ON/OFF of the standard compressor and inverter output frequency so that discharge pressure is the optimal value.



2 Diagnosis by Malfunction Code

Malfunction code	Malfunction contents	Fan operation	Page
A0	Indoor unit: Error of external protection device		95
A1	Indoor unit: PC board defect		95
A3	Indoor unit: Malfunction of drain level control system (33H)	○	96
A6	Indoor unit: Fan motor (M1F) lock, overload		97
A7	Indoor unit: Malfunction of swing flap motor (M1S)	○	98
A9	Indoor unit: Malfunction of moving part of electronic expansion valve (Y1E)	○	99
AF	Indoor unit: Drain level above limit		100
AJ	Indoor unit: Malfunction of capacity determination device		101
C4	Indoor unit: Malfunction of thermistor (R2T) for liquid pipe	○	102
C5	Indoor unit: Malfunction of thermistor (R3T) for gas pipes	○	102
C9	Indoor unit: Malfunction of thermistor (R1T) for air inlet	○	103
CJ	Indoor unit: Malfunction of thermostat sensor in remote controller	○	103
E0	Outdoor unit: Actuation of safety device		104
E1	Outdoor unit: PC board defect		105
E3	Outdoor unit: Actuation of high pressure switch		105
E4	Outdoor unit: Actuation of low pressure switch	○	106
E9	Outdoor unit: Malfunction of moving part of electronic expansion valve (Y1E)	○	107
F3	Outdoor unit: Abnormal discharge pipe temperature	○	108
H9	Outdoor unit: Malfunction of thermistor for outdoor air (R1T)	○	109
J3	Outdoor unit: Malfunction of discharge pipe thermistor (R3T)	○	109
J5	Outdoor unit: Malfunction of thermistor (R4T) for suction pipe	○	110
J6	Outdoor unit: Malfunction of thermistor (R2T) for heat exchanger	○	110
JA	Outdoor unit: Malfunction of discharge pipe pressure sensor	○	111
JC	Outdoor unit: Malfunction of suction pipe pressure sensor	○	112
JH	Outdoor unit: Malfunction of oil temperature thermistor (R5T)	○	113
U0	Low pressure drop due to refrigerant shortage or electronic expansion valve failure	○	114
U1	Negative phase, open phase	○	115
U2	Power supply insufficient or instantaneous failure	○	131
U4	Malfunction of transmission between indoor units	○	116
U5	Malfunction of transmission between remote controller and indoor unit		117
U7	Malfunction of transmission between outdoor units	○	118
U8	Malfunction of transmission between master and slave remote controllers	○	119
U9	Malfunction of transmission between indoor and outdoor units in the same system	○	120
UA	Excessive number of indoor units	○	121
UC	Address duplication of central remote controller	○	121
UF	Refrigerant system not set, incompatible wiring/piping	○	122
UH	Malfunction of system, refrigerant system address undefined	○	123

Inverter failure diagnosis

Malfunction code	Malfunction contents	Fan operation	Page
L4	Outdoor unit: Malfunction of inverter radiating fin temperature rise	○	126
L5	Outdoor unit: Inverter instantaneous over-current	○	127
L8	Outdoor unit: Inverter thermostat sensor, compressor overload	○	128
L9	Outdoor unit: Inverter stall prevention, compressor lock	○	129
LC	Outdoor unit: Malfunction of transmission between inverter and control PC board	○	130
P1	Outdoor unit: Inverter over-ripple protection	○	132
P4	Outdoor unit: Malfunction of inverter radiating fin temperature rise sensor	○	133

Failure diagnosis for optional controllers for centralized control

Malfunction code	Optional controllers for centralized control	Malfunction contents	Page
UE	Central remote controller Schedule timer	Malfunction of transmission between central remote controller and indoor unit	134
			138
M1	Central remote controller Schedule timer	PC board defect	135
			139
M8	Central remote controller Schedule timer	Malfunction of transmission between optional controllers for centralized control	135 139
MA	Central remote controller Schedule timer	Improper combination of optional controllers for centralized control	136 140
MC	Central remote controller Schedule timer	Address duplication, improper setting	137
			141
—	Unified ON/OFF controller	Operation lamp blinks	142
		Display "under host computer integrate control" blinks (repeats single blink)	143
		Display "under host computer integrate control" blinks (repeats double blink)	145

Все каталоги и инструкции здесь: <https://splitssystema48.ru/instrukcii-po-ekspluatatsii-kondicionerov.html>



3. Failure Diagnosis

Remote controller display

Malfunction code "A0" blinks.

Cause of malfunction

- (1) Actuation of external protection device
- (2) Improper field set
- (3) Defect of indoor unit PC board

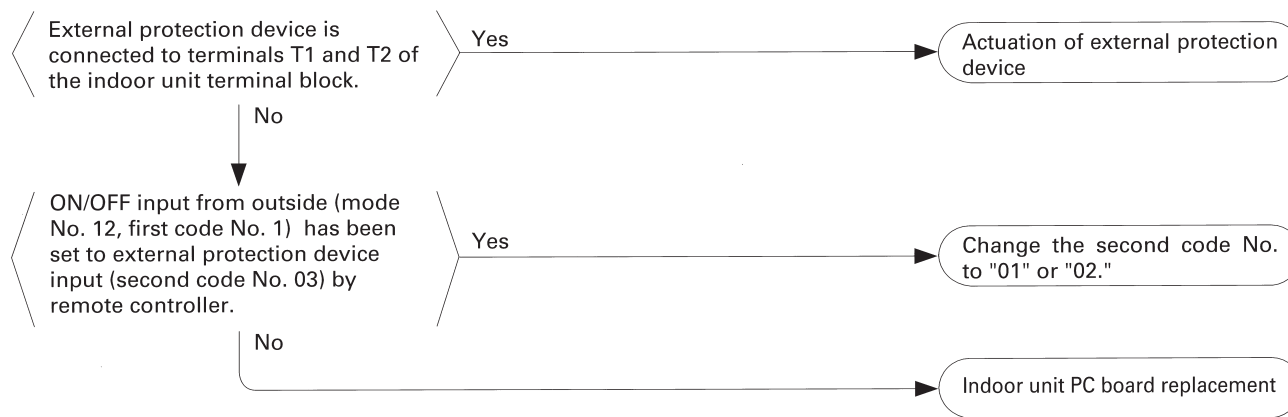

Remote controller display

Malfunction code "A1" blinks.

Cause of malfunction

- (1) Defect of indoor unit PC board

Replace the indoor unit PC board.





**Remote controller display
Malfunction code "A3" blinks.**

Cause of malfunction

- (1) Defect of float switch or short circuit connector
- (2) Defect of drain pump
- (3) Drain clogging, upward slope, etc.
- (4) Defect of indoor unit PC board
- (5) Loose connection of connector

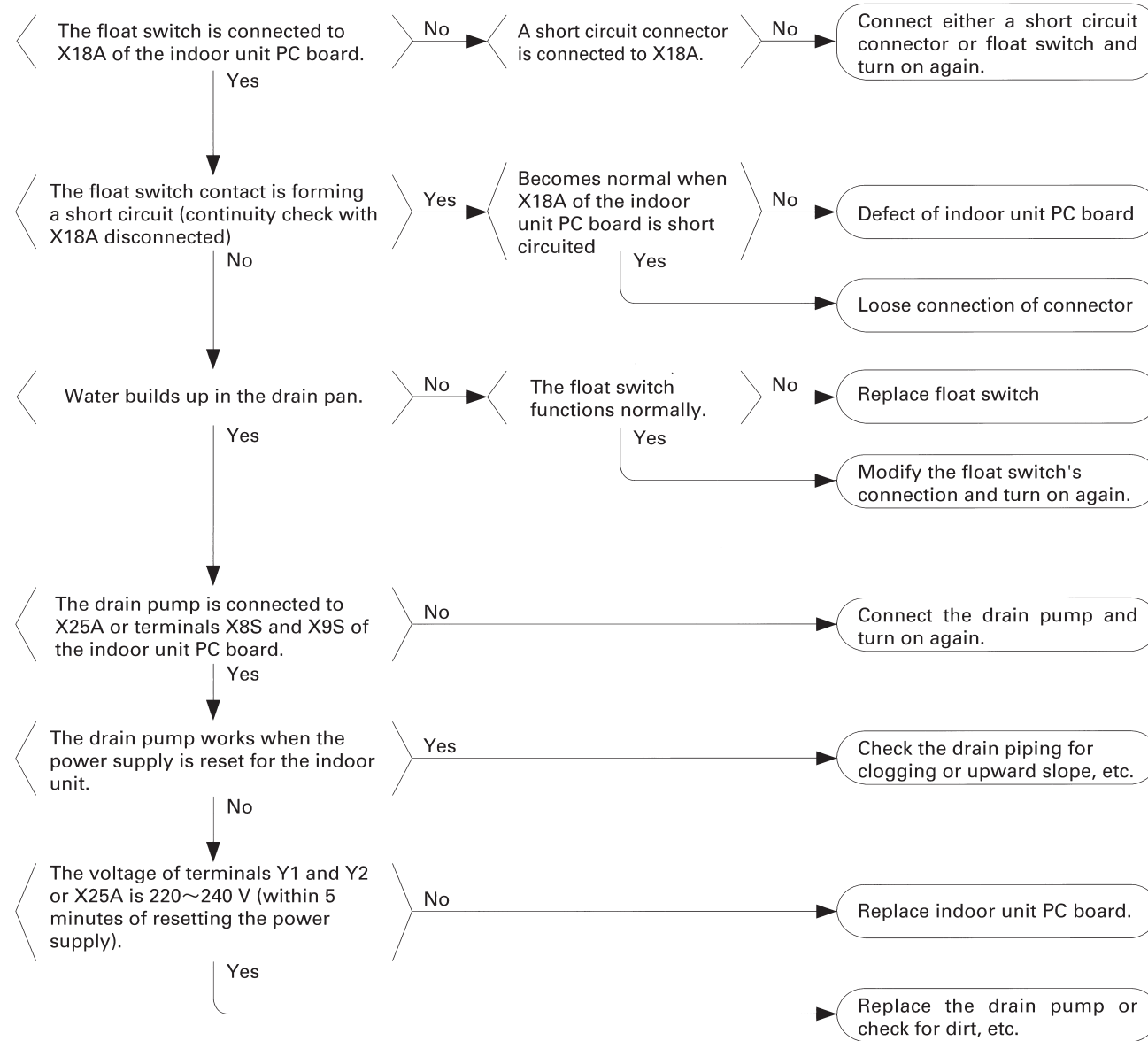



**Remote controller display
Malfunction code "A6" blinks.**

Cause of malfunction

(1) Fan motor lock

(2) Disconnected or faulty wiring between fan motor and PC board

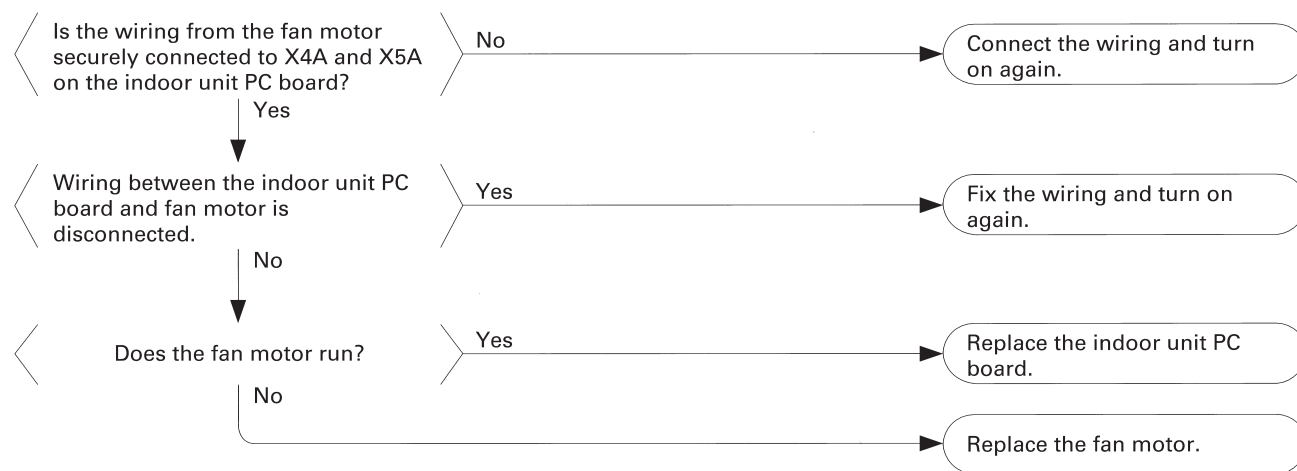



Remote controller display

Malfunction code "A7" blinks.

Cause of malfunction

- (1) Defect of swing motor
- (2) Defect of connection cable (power supply and limit switch)
- (3) Defect of air flow direction adjusting flap-cam
- (4) Defect of indoor unit PC board

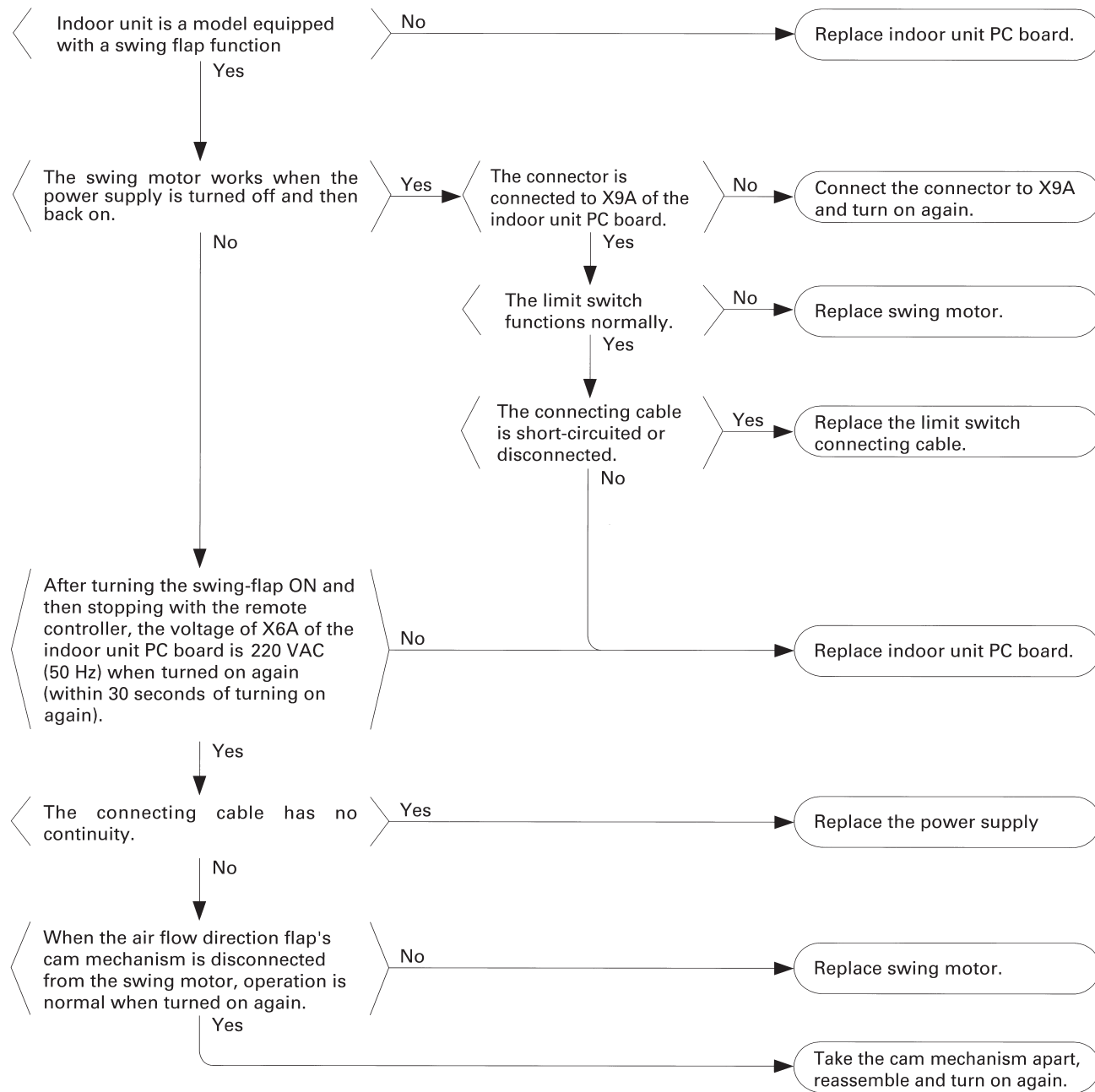



Remote controller display

Malfunction code "A9" blinks.

Cause of malfunction

- (1) Malfunction of moving part of electronic expansion valve
- (2) Defect of indoor unit PC board
- (3) Defect of connecting cable

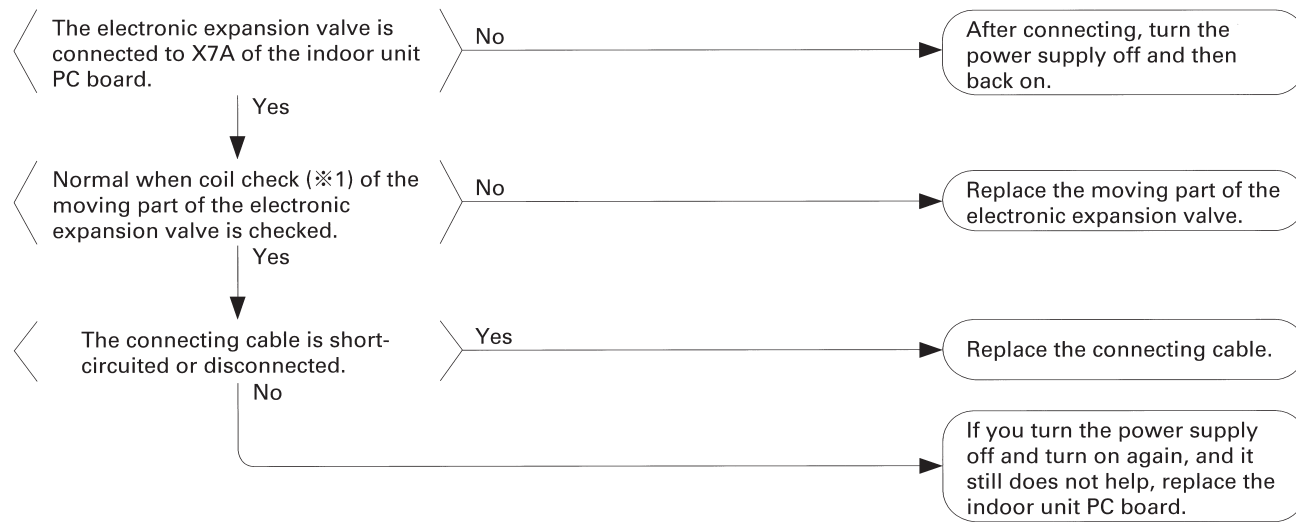

※1: Coil check method for the moving part of the electronic expansion valve

(Normal)

Pin No.	①White	②Yellow	③Orange	④Blue	⑤Red	⑥Brown
①White		×	○ Approx. 300 Ω	×	○ Approx. 150 Ω	×
②Yellow			×	○ Approx. 300 Ω	×	○ Approx. 150 Ω
③Orange				×	○ Approx. 150 Ω	×
④Blue					×	○ Approx. 150 Ω
⑤Red						×
⑥Brown						

○: Continuity
 ×: No continuity





Remote controller display

Malfunction code "AF" blinks.

Cause of malfunction

- (1) Humidifier unit (optional accessory) leaking
- (2) Defect of drain pipe (upward slope, etc.)
- (3) Defect of indoor unit PC board

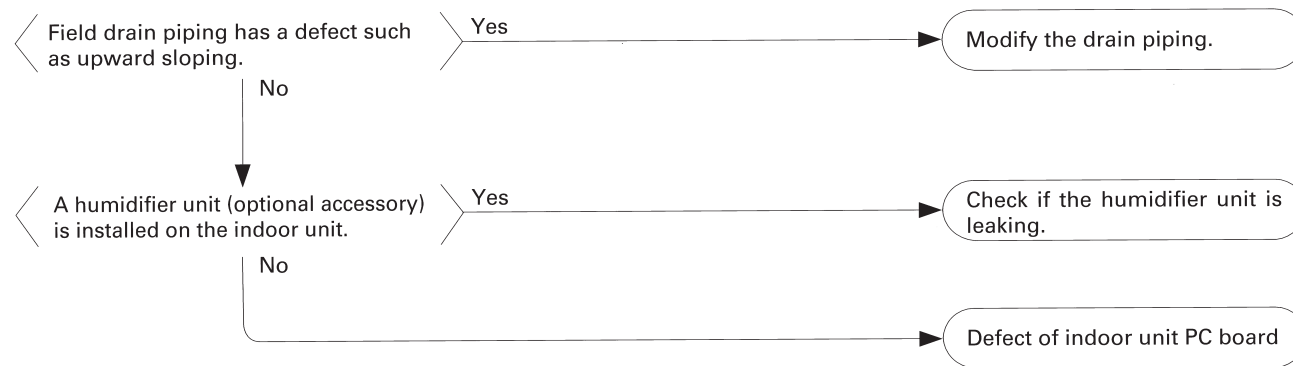



Remote controller display
Malfunction code "AJ" blinks.

Cause of malfunction

- (1) You have forgotten to install the capacity setting adaptor.
- (2) Defect of indoor unit PC board

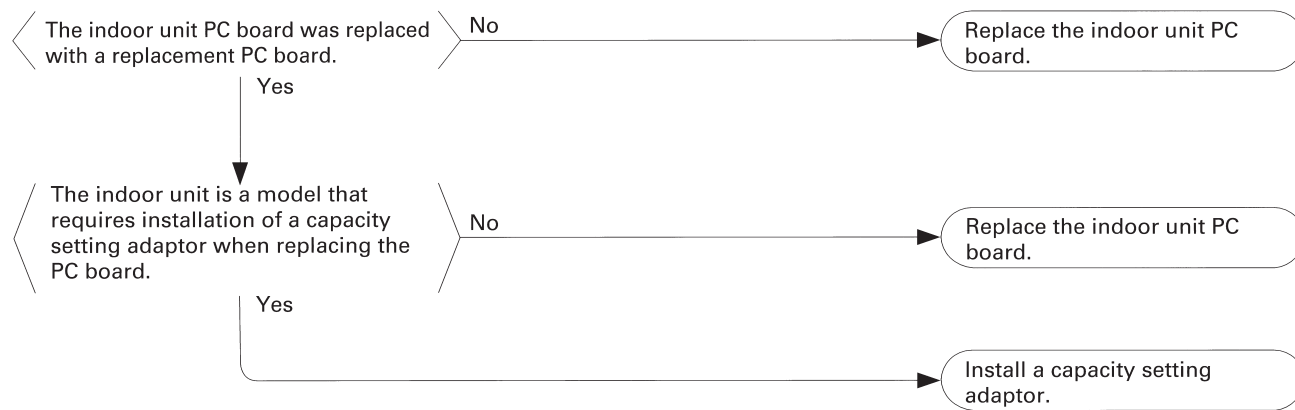



Remote controller display

Malfunction code "C4" blinks.

Cause of malfunction

- (1) Defect of thermistor (R2T) for liquid pipe
- (2) Defect of indoor unit PC board

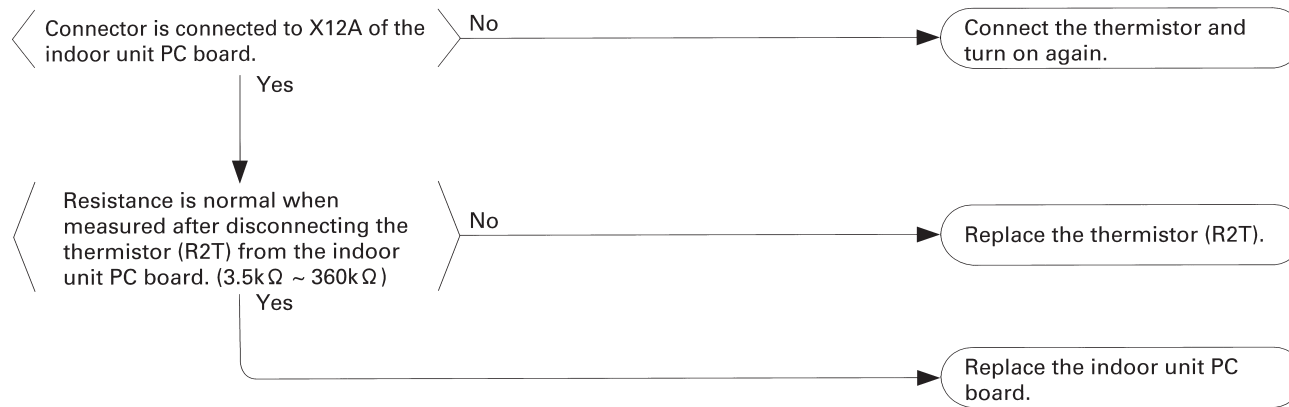

Remote controller display

Malfunction code "C5" blinks.

Cause of malfunction

- (1) Defect of indoor unit thermistor (R3T) for gas pipe
- (2) Defect of indoor unit PC board

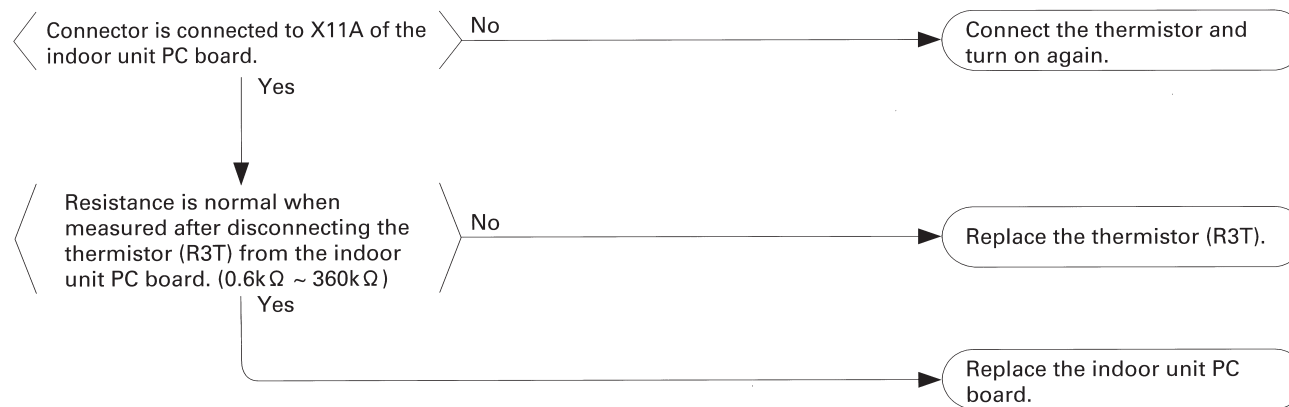



Remote controller display
Malfunction code "C9" blinks.

Cause of malfunction

- (1) Defect of indoor unit thermistor (R1T) for air inlet
- (2) Defect of indoor unit PC board

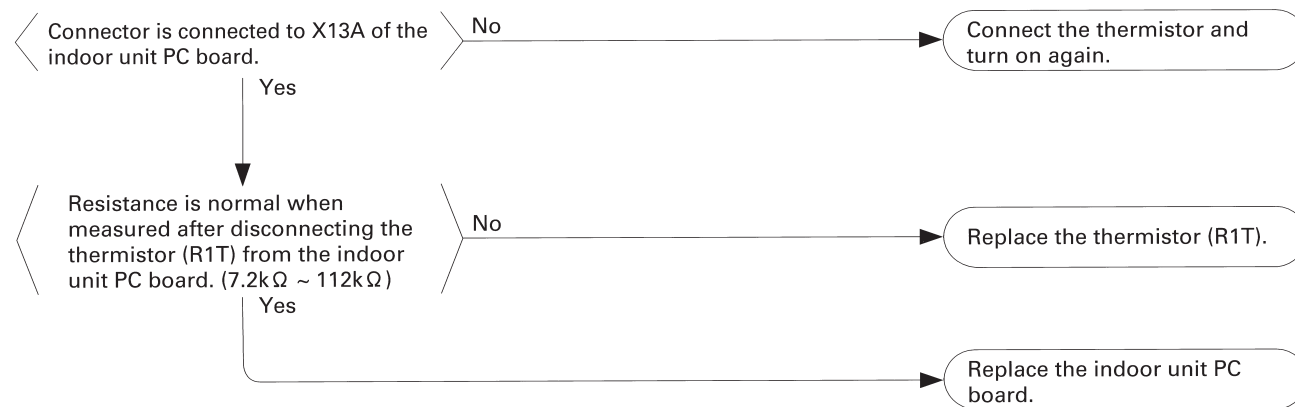

Remote controller display
Malfunction code "CJ" blinks.

Cause of malfunction

- (1) Defect of remote controller thermistor
- (2) Defect of remote controller PC board



**Remote controller display
Malfunction code "E0" blinks.**

Cause of malfunction

- (1) Actuation of outdoor unit safety device
- (2) Defect of outdoor unit PC board
- (3) Instantaneous power failure

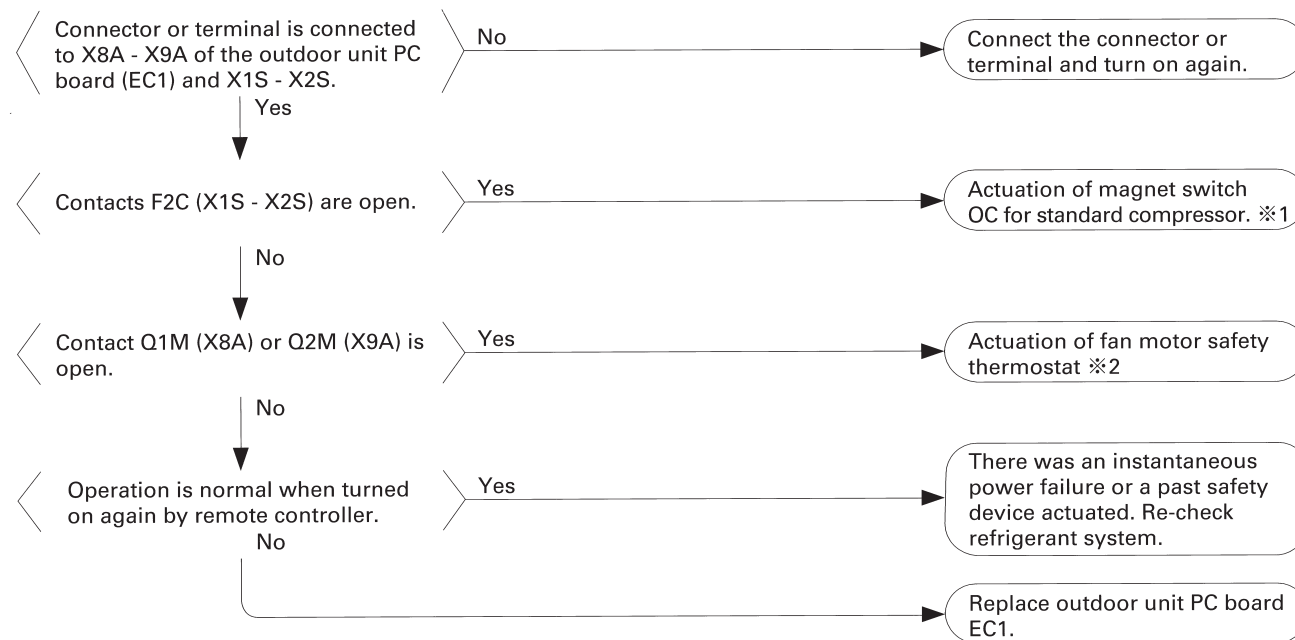

※1: Actuation of magnet switch OC
Defect of compressor
Power supply insufficient
Defect of magnet switch, etc.

※2: Actuation of fan motor safety thermostat
Defect of fan motor
Defect of capacitor, etc.



Remote controller display

Malfunction code "E1" blinks.

Cause of malfunction

- (1) Defect of outdoor unit PC board (EC1)

Replace outdoor unit PC board EC1.

Remote controller display

Malfunction code "E3" blinks.

Cause of malfunction

- (1) Actuation of outdoor unit high pressure switch
- (2) Defect of outdoor unit PC board (EC1)
- (3) Instantaneous power failure

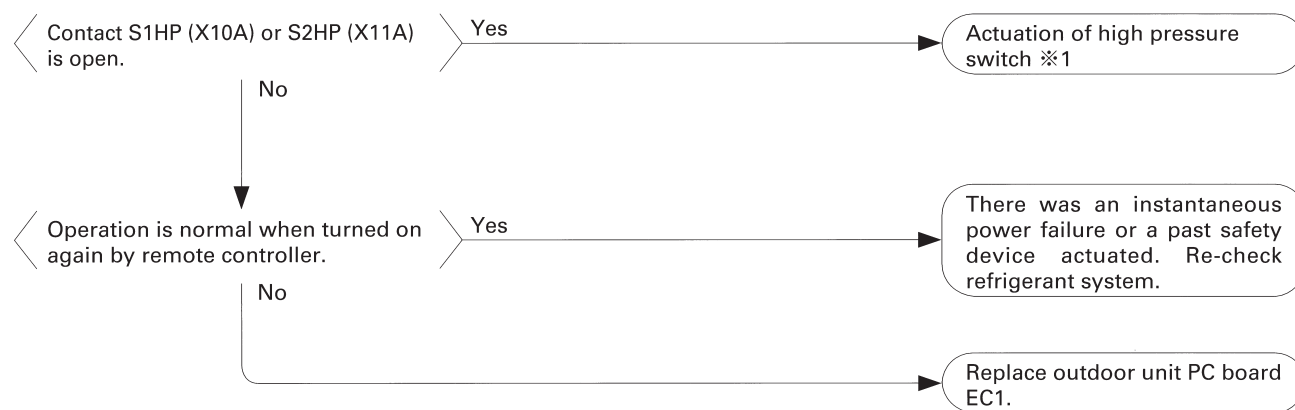

※1: Actuation of high pressure switch (HPS)
The outdoor unit PC board's connector is disconnected.
Is the outdoor unit heat exchanger dirty?
Defect of outdoor fan
Is the refrigerant over-filled?



**Remote controller display
Malfunction code "E4" blinks.**

Cause of malfunction

- (1) Abnormal drop of low pressure (0 kg/cm² [0 MPa])
- (2) Defect of low pressure sensor
- (3) Defect of outdoor unit PC board

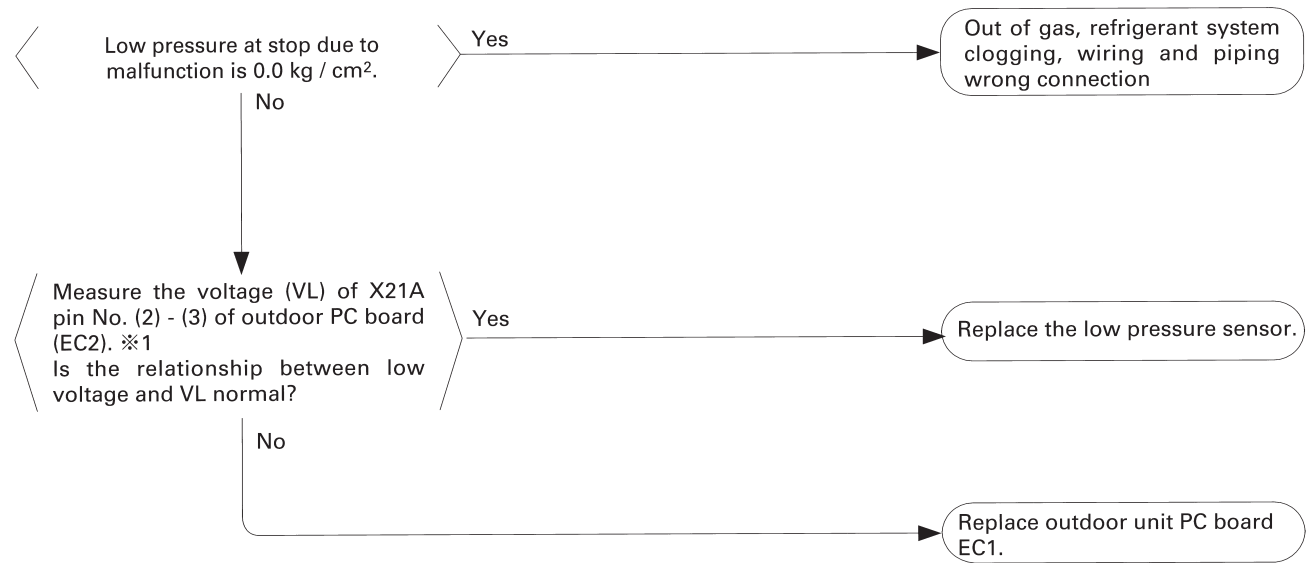

*1: Voltage measurement point

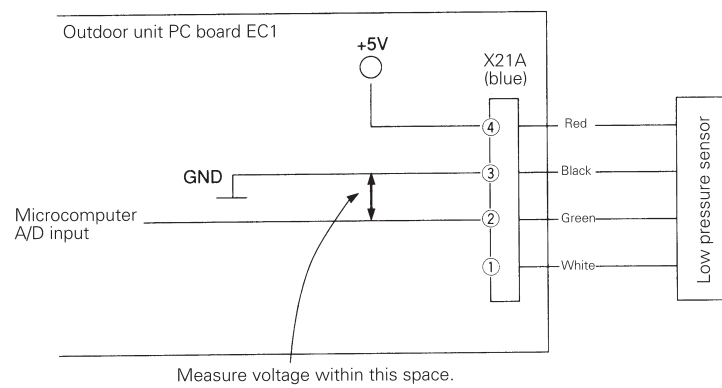

*Refer to the pressure sensor, pressure - voltage characteristics table on P321.



**Remote controller display
Malfunction code "E9" blinks.**

Cause of malfunction

- (1) Defect of moving part of electronic expansion valve
- (2) Defect of outdoor unit PC board (EC1)
- (3) Defect of connecting cable

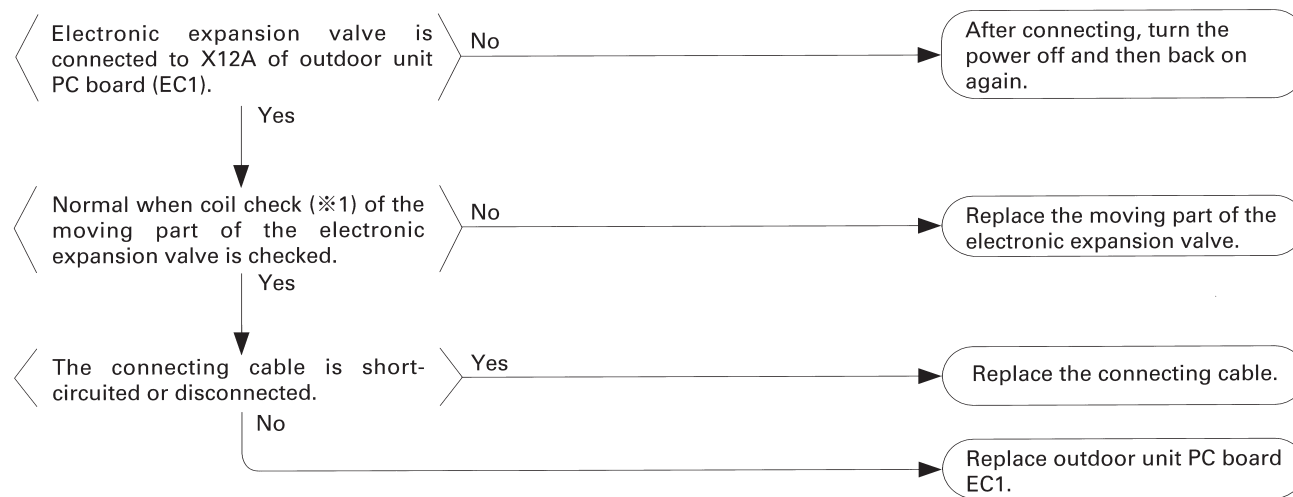

※1 Coil check method for the moving part of the electronic expansion valve
Disconnect the electronic expansion valve from the PC board and check the continuity between the connector pins.

(Normal)

Pin No.	①White	②Yellow	③Orange	④Blue	⑤Red	⑥Brown
①White		×	⊙	×	○	×
②Yellow			×	⊙	×	○
③Orange				×	○	×
④Blue					×	○
⑤Red						×
⑥Brown						

⊙: Continuity
Approx. 300Ω
○: Continuity
Approx. 150Ω
×: No continuity



**Remote controller display
Malfunction code "F3" blinks.**

Cause of malfunction

- (1) Abnormal discharge pipe temperature
- (2) Defect of discharge pipe thermistor (5K: R3T 8K, 10K: R3-1T, R3-2T)
- (3) Defect of outdoor unit PC board
- (4) Discharge pipe thermistor wrong connection
- (5) Liquid injection solenoid valve wrong connection

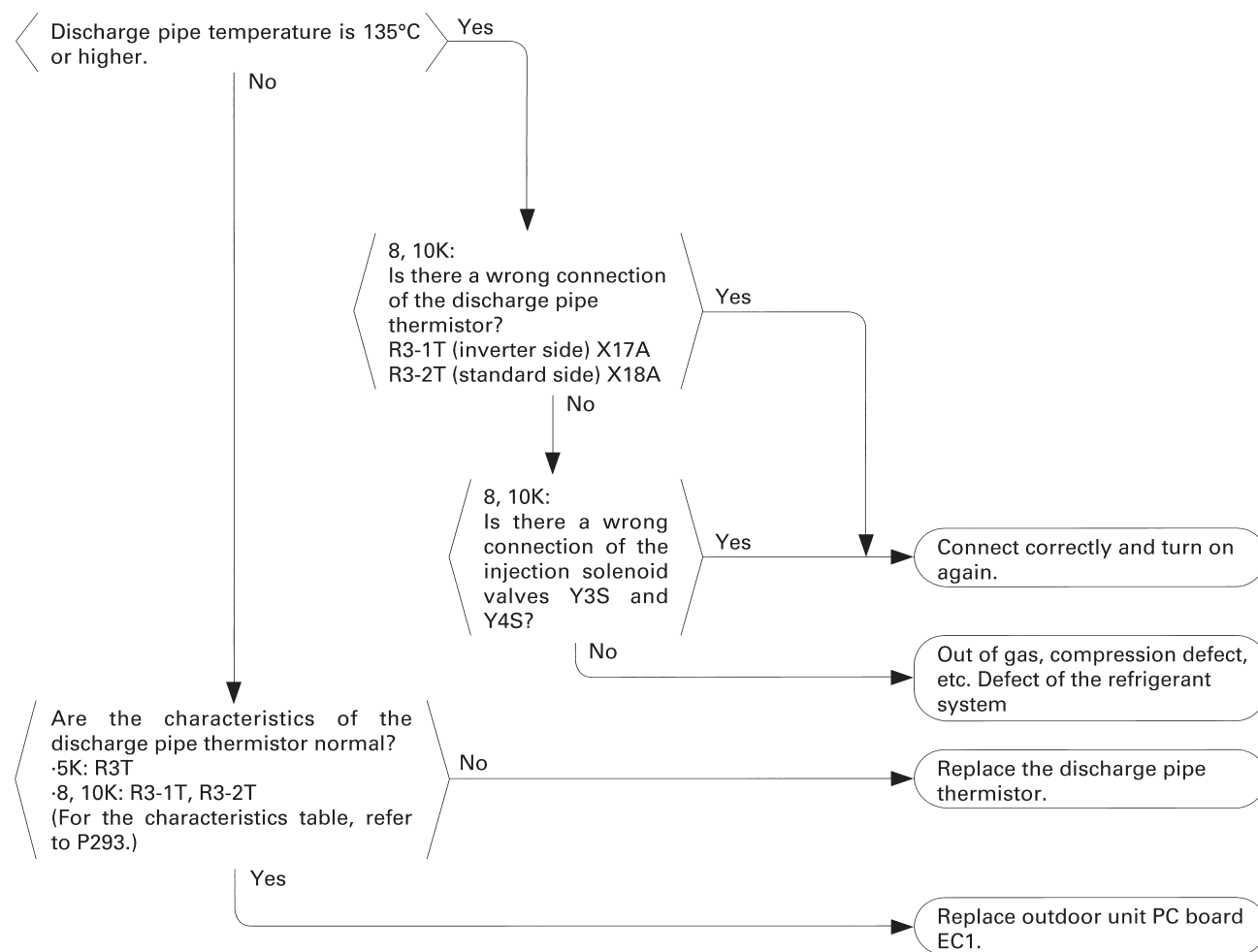



Remote controller display

Malfunction code "H9" blinks.

Cause of malfunction

- (1) Defect of thermistor (R1T) for outdoor unit outdoor air intake
- (2) Defect of outdoor unit PC board (EC1)

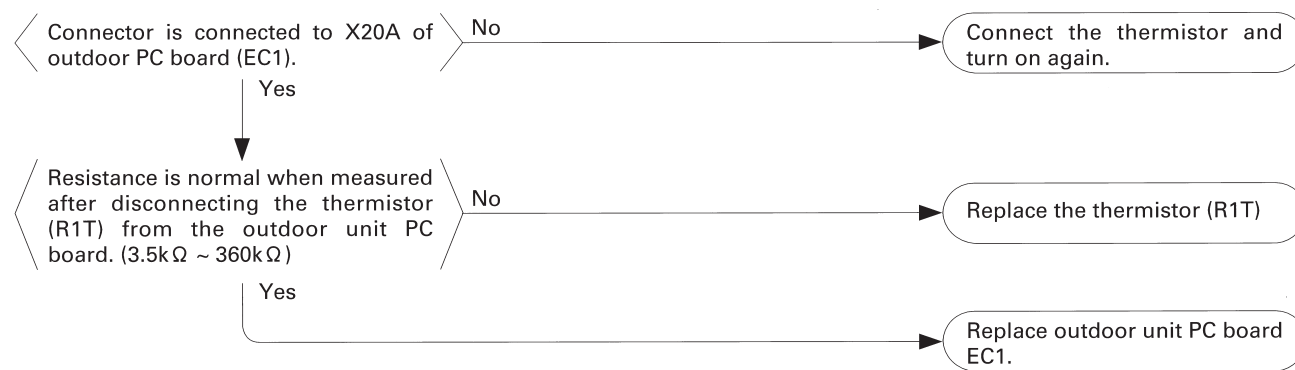

The alarm indicator is displayed when the fan is being used also.



Remote controller display

Malfunction code "J3" blinks.

Cause of malfunction

- (1) Defect of thermistor (R3T, R3-1T, R3-2T) for outdoor unit discharge pipe
- (2) Defect of outdoor unit PC board (EC1)

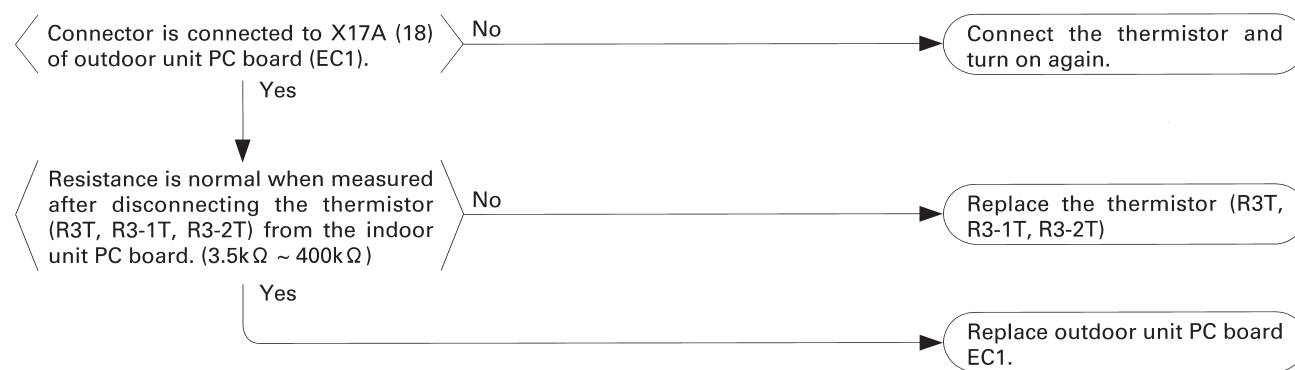

The alarm indicator is displayed when the fan is being used also.



Remote controller display

Malfunction code "J5" blinks.

Cause of malfunction

- (1) Defect of thermistor (R4T) for outdoor unit suction pipe
- (2) Defect of outdoor unit PC board (EC1)

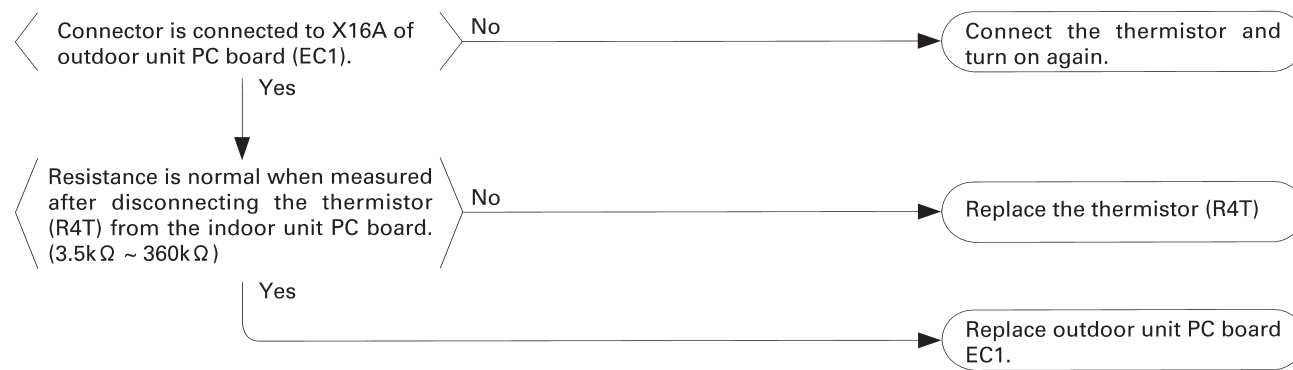

The alarm indicator is displayed when the fan is being used also.

Remote controller display

Malfunction code "J6" blinks.

Cause of malfunction

- (1) Defect of thermistor (R2T) for outdoor unit coil
- (2) Defect of outdoor unit PC board (EC1)

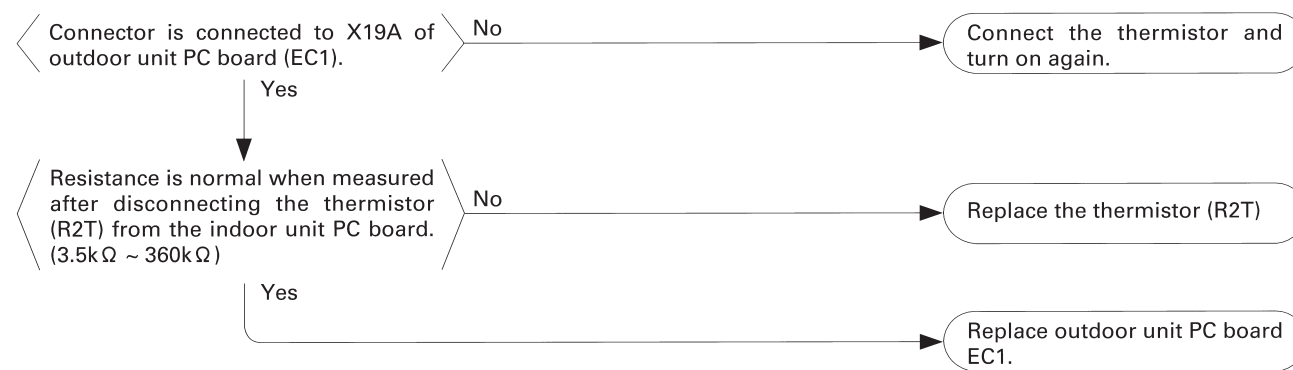

The alarm indicator is displayed when the fan is being used also.



**Remote controller display
Malfunction code "JA" blinks.**

Cause of malfunction

- (1) Defect of high pressure sensor system
- (2) Connection of low pressure sensor with wrong connection.
- (3) Defect of outdoor unit PC board.

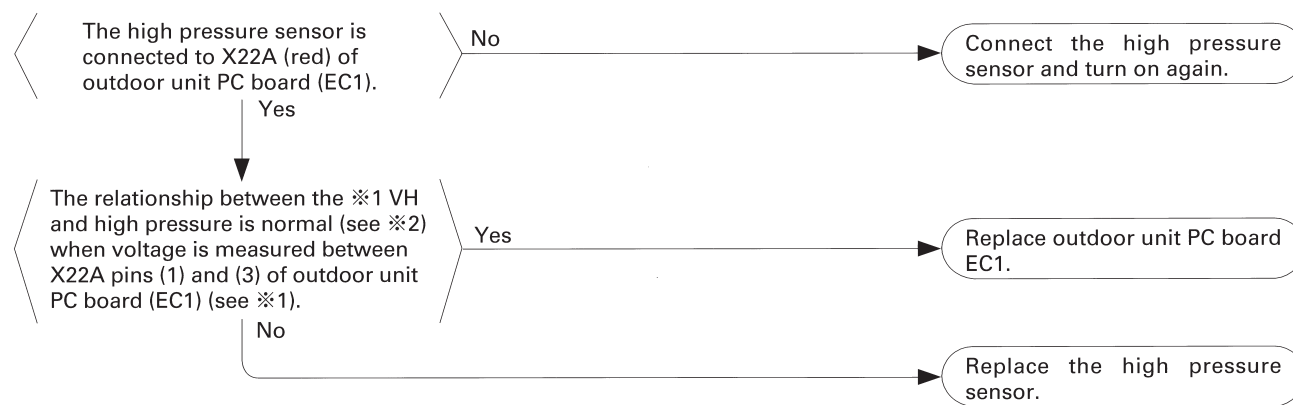

※1: Voltage measurement point

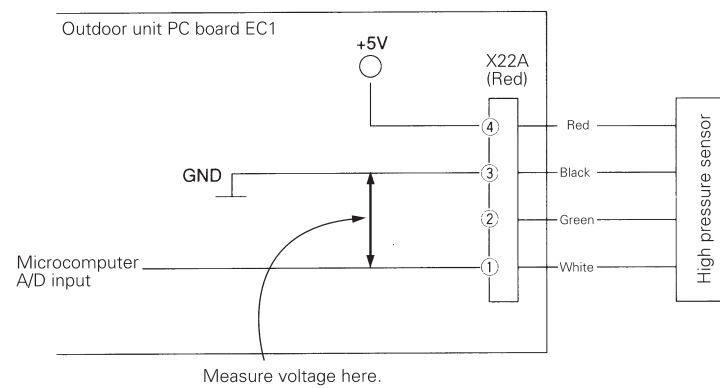

※2: Refer to pressure sensor, pressure / voltage characteristics table, P321.





Remote controller display

Malfunction code "JC" blinks.

Cause of malfunction

- (1) Defect of low pressure sensor system
- (2) Connection of high pressure sensor with wrong connection.
- (3) Defect of outdoor unit PC board.

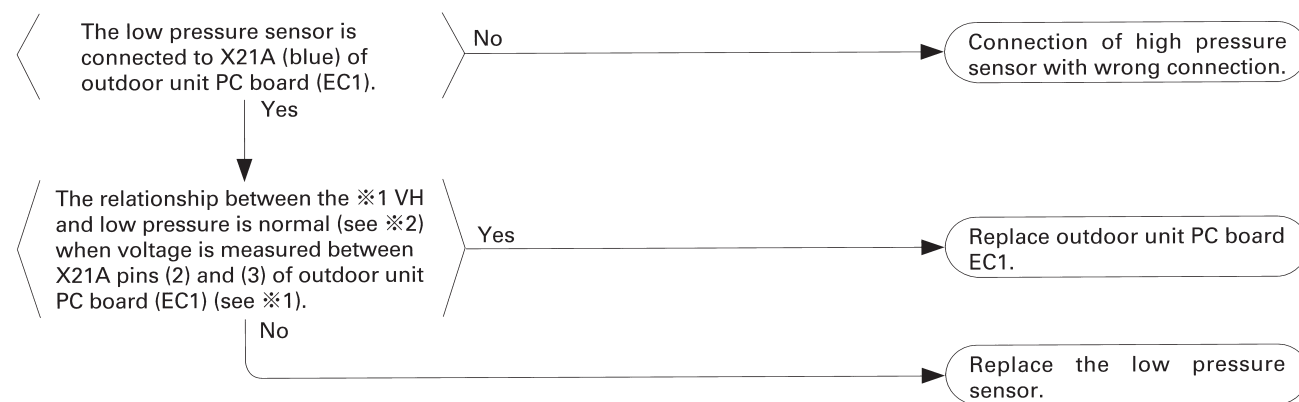

※1: Voltage measurement point

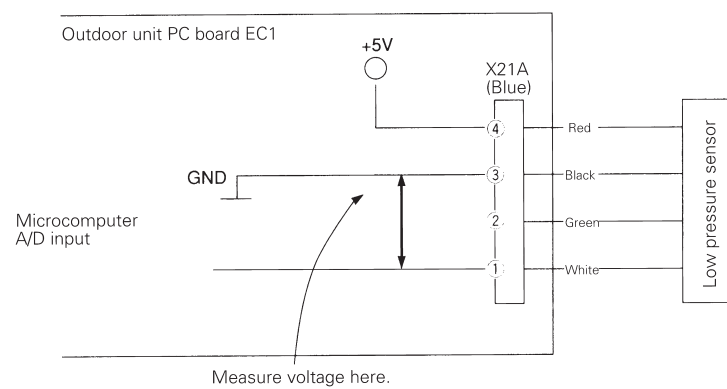

※2: Refer to pressure sensor, pressure/voltage characteristics table, P321.





Remote controller display
Malfunction code "JH" blinks.

Cause of malfunction

- (1) Defect of oil temperature thermistor (R5T)
- (2) Defect of outdoor unit PC board (EC1)

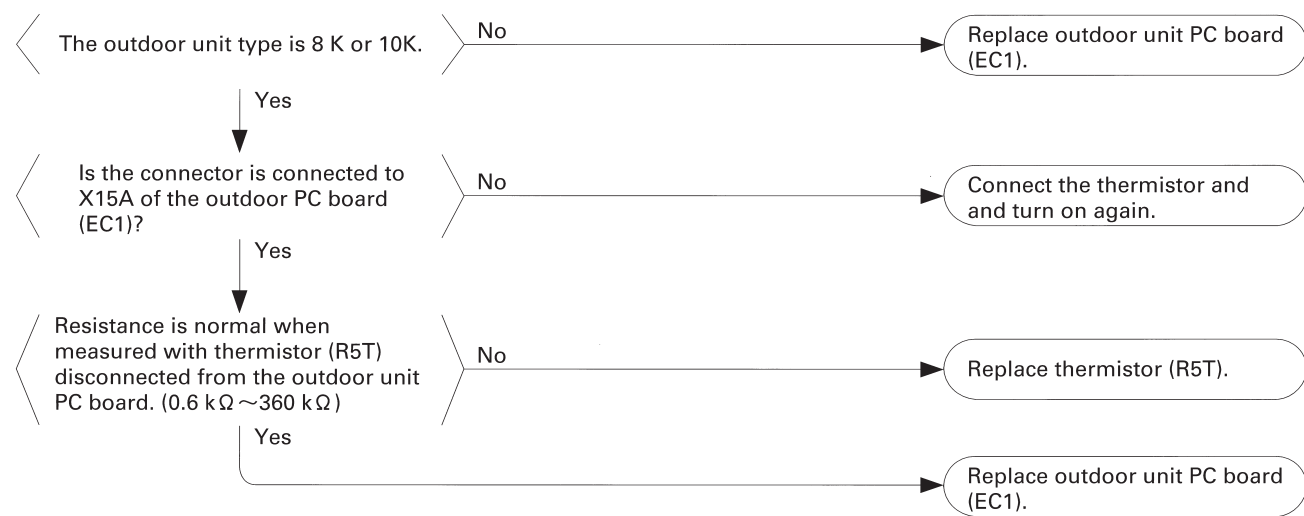

**Remote controller display
Malfunction code "U0" blinks.**

Cause of malfunction

- (1) Out of gas or refrigerant system clogging (incorrect piping)
- (2) Defect of pressure sensor
- (3) Defect of outdoor unit PC board

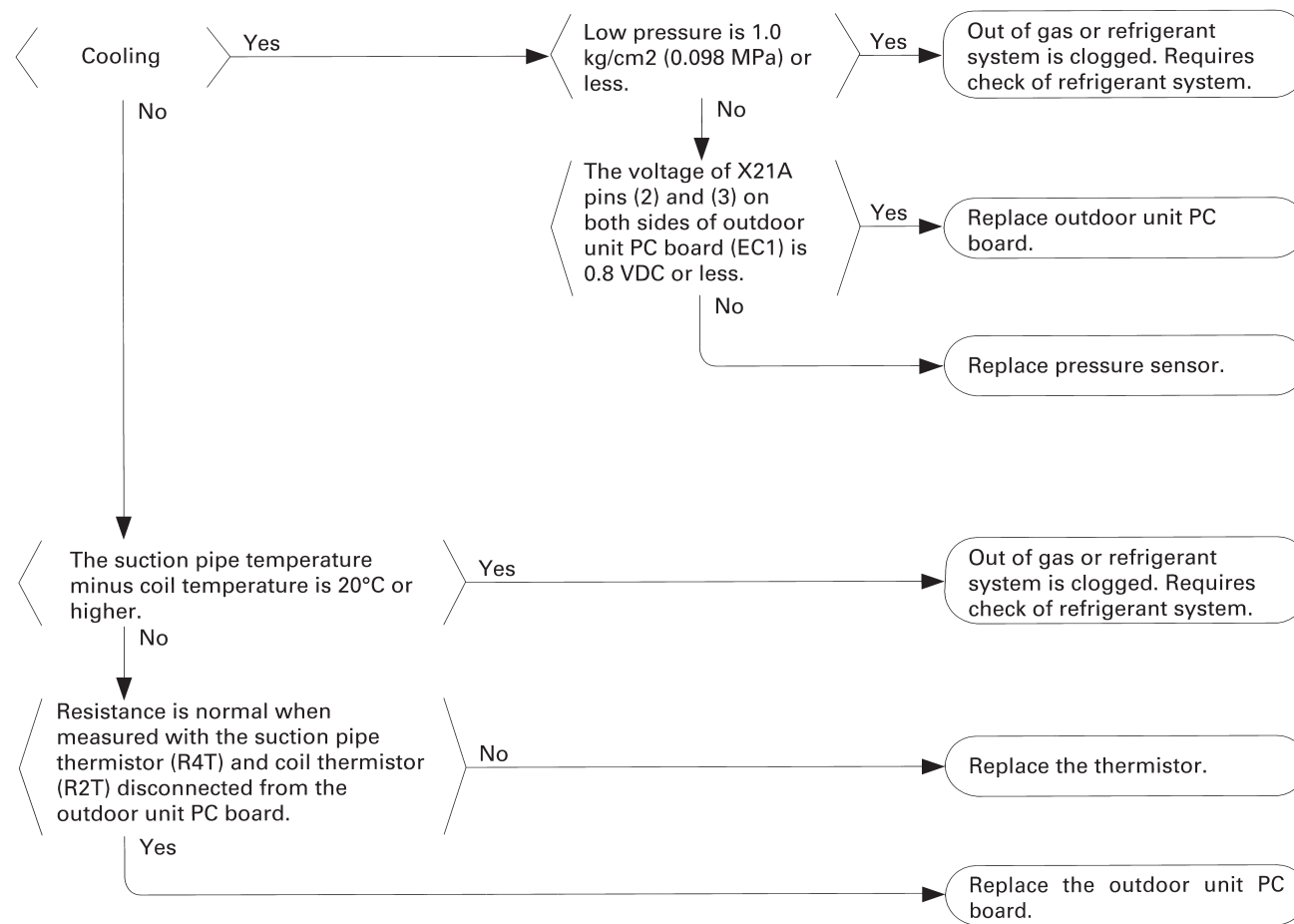



**Remote controller display
Malfunction code "U1" blinks.**

Cause of malfunction

- (1) Power supply negative phase
- (2) Power supply open phase
- (3) Defect of outdoor PC board EC1

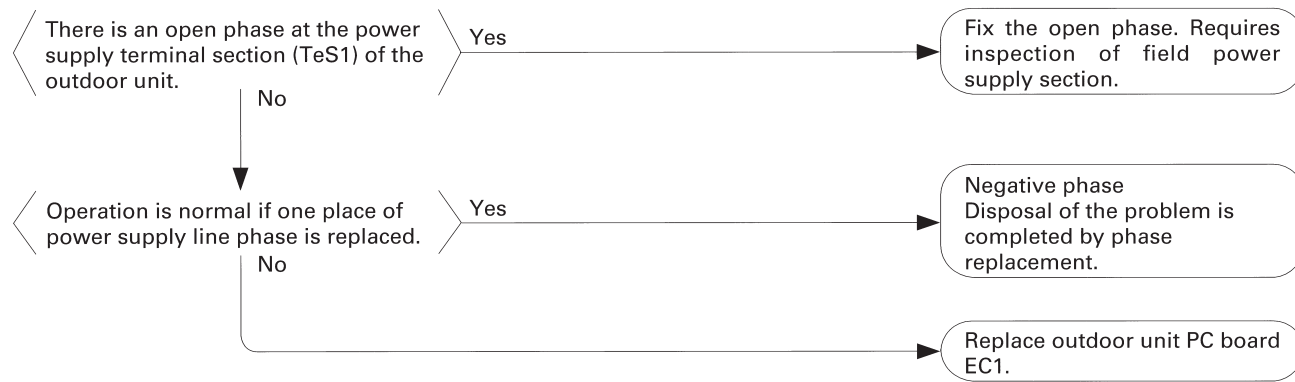



**Remote controller display
Malfunction code "U4" blinks.**

Cause of malfunction

- (1) Indoor to outdoor, outdoor to outdoor crossover wiring disconnection, short circuit or wrong check
- (2) Outdoor unit power supply is OFF
- (3) System address doesn't match
- (4) Defect of indoor unit PC board
- (5) Defect of outdoor unit PC board

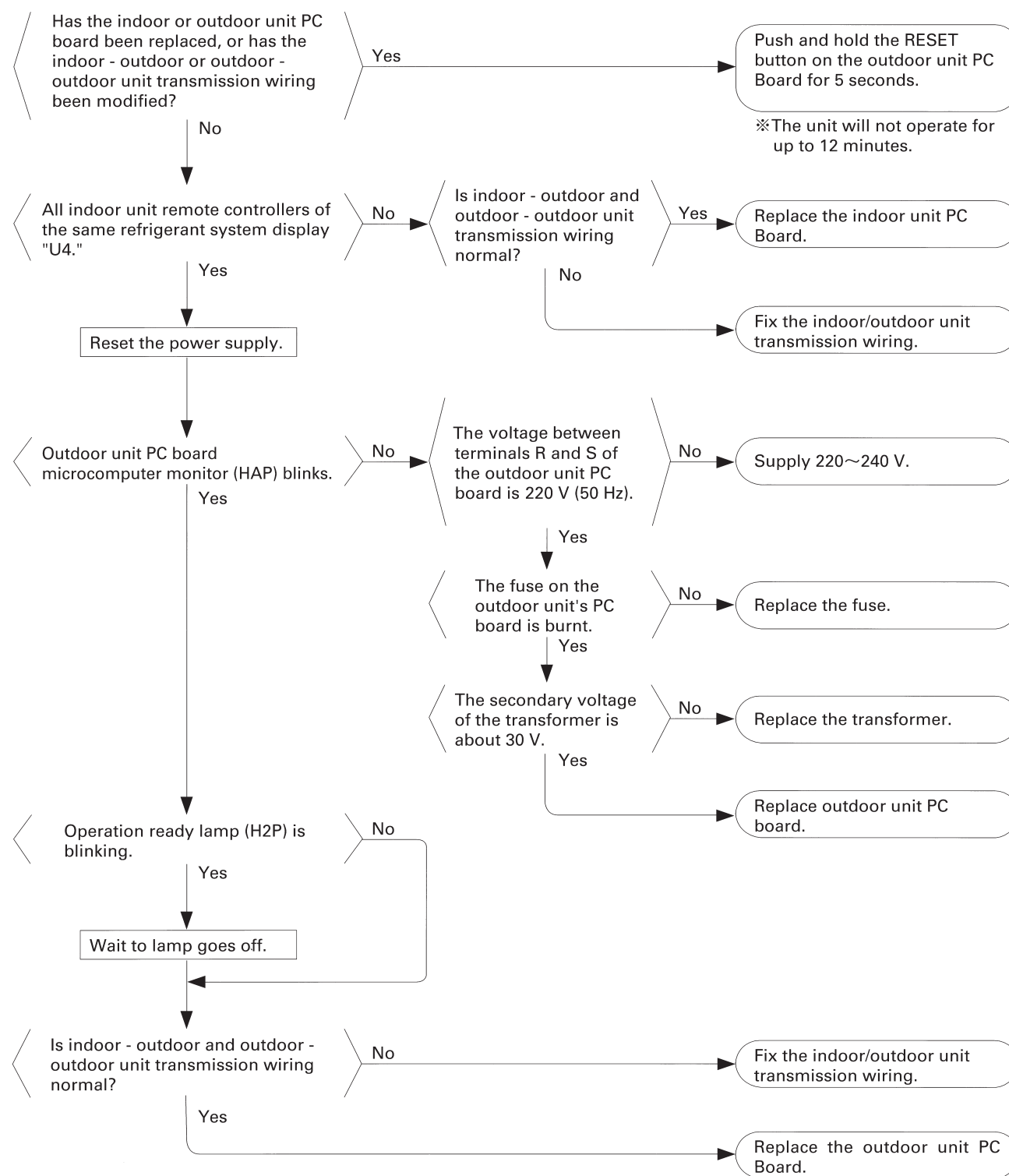



Remote controller display
Malfunction code "U5" blinks.

Cause of malfunction

- (1) Malfunction of indoor unit remote controller transmission
- (2) Connection of two main remote controllers (when using 2 remote controllers)
- (3) Defect of indoor unit PC board
- (4) Defect of remote controller PC board
- (5) Malfunction of transmission caused by noise

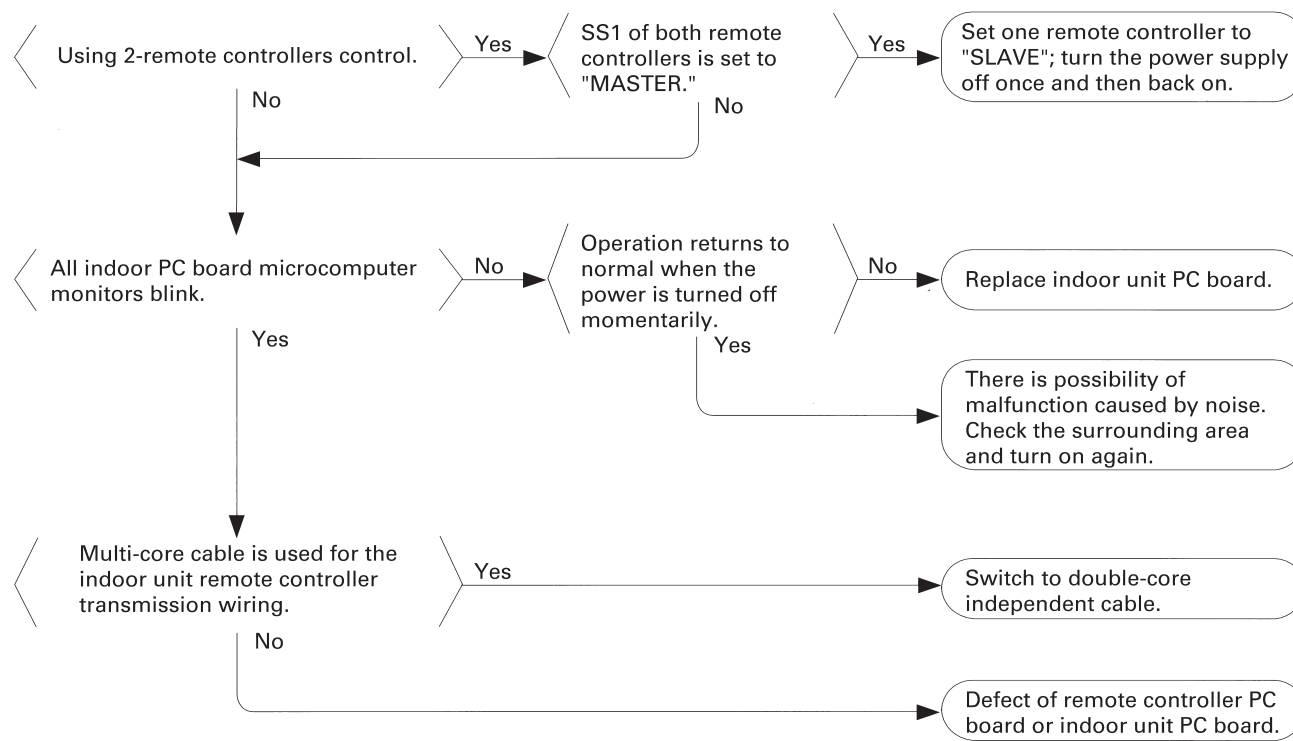



Remote controller display
Malfunction code "U7" blinks.

Cause of malfunction

- (1) Improper connection of transmission wiring between outdoor unit and outdoor unit outside control adaptor
- (2) Improper cool/heat selection
- (3) Improper cool/heat unified address (outdoor unit, external control adaptor for outdoor unit)
- (4) Defect of outdoor unit PC board (EC1)
- (5) Defect of outdoor unit outside control adaptor

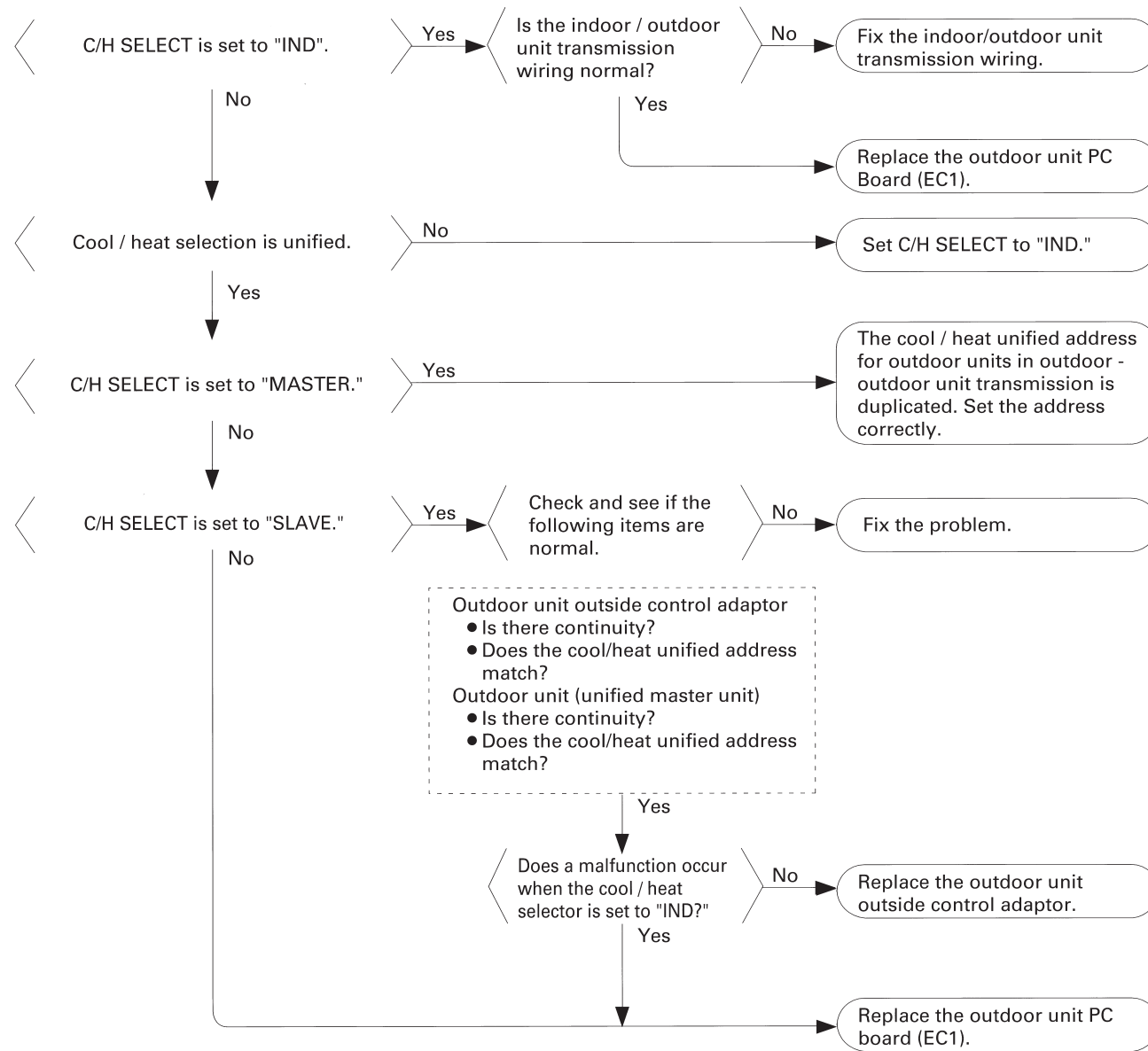



Remote controller display
Malfunction code "U8" blinks.

Cause of malfunction

- (1) Malfunction of transmission between main and sub remote controller
- (2) Connection between sub remote controllers
- (3) Defect of remote controller PC board

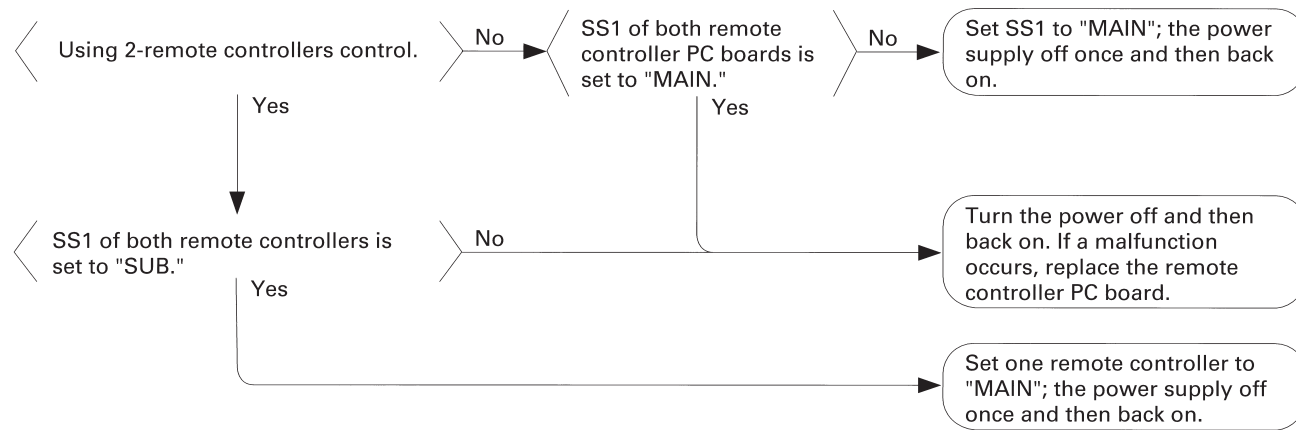

Remote controller display

Malfunction code "U9" blinks.

Cause of malfunction

- (1) Malfunction of transmission within or outside of other system
- (2) Malfunction of electronic expansion valve in indoor unit of other system
- (3) Defect of PC board of indoor unit in other system
- (4) Improper connection of transmission wiring between indoor and outdoor unit

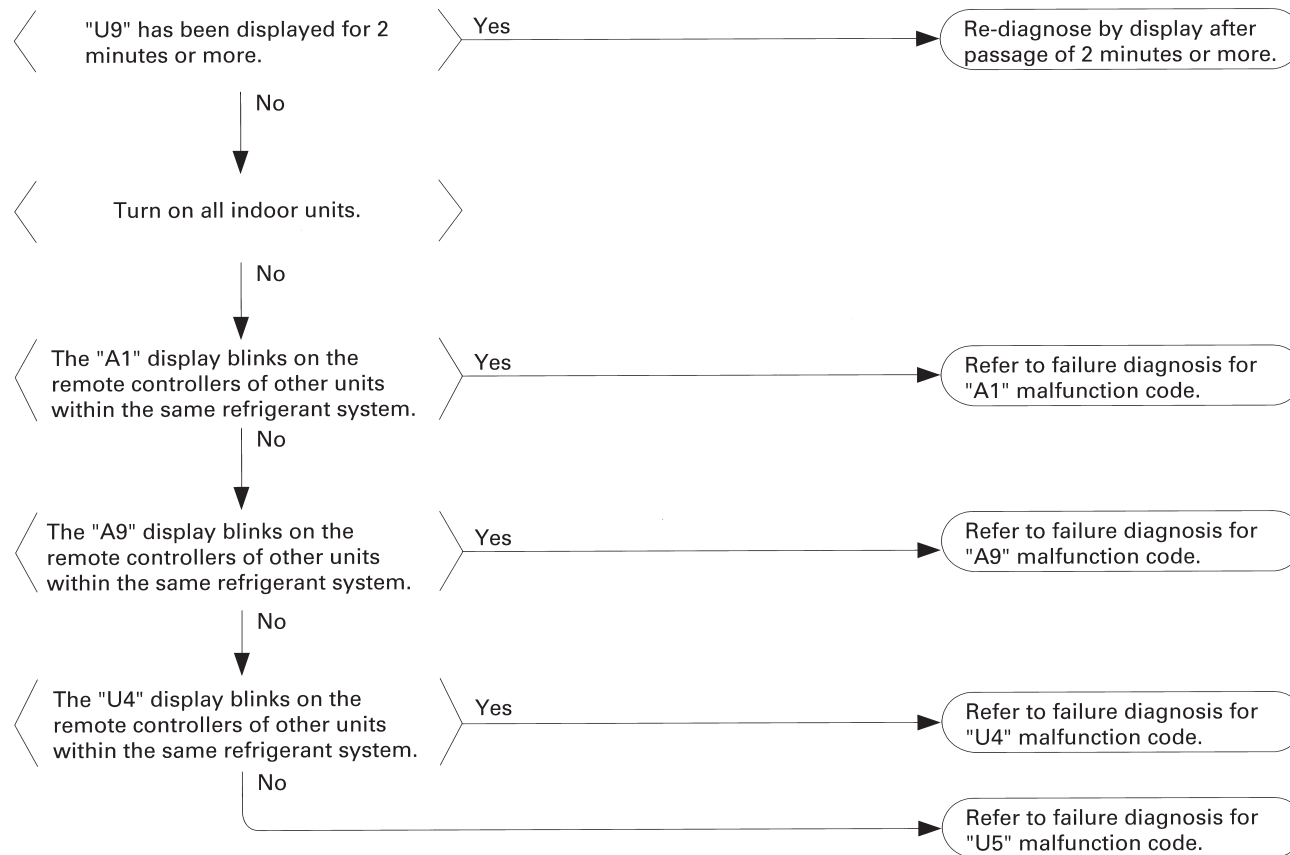



Remote controller display
Malfunction code "UA" blinks.

Cause of malfunction

- (1) Excess of connected indoor units
- (2) Defect of outdoor unit PC board (EC1)

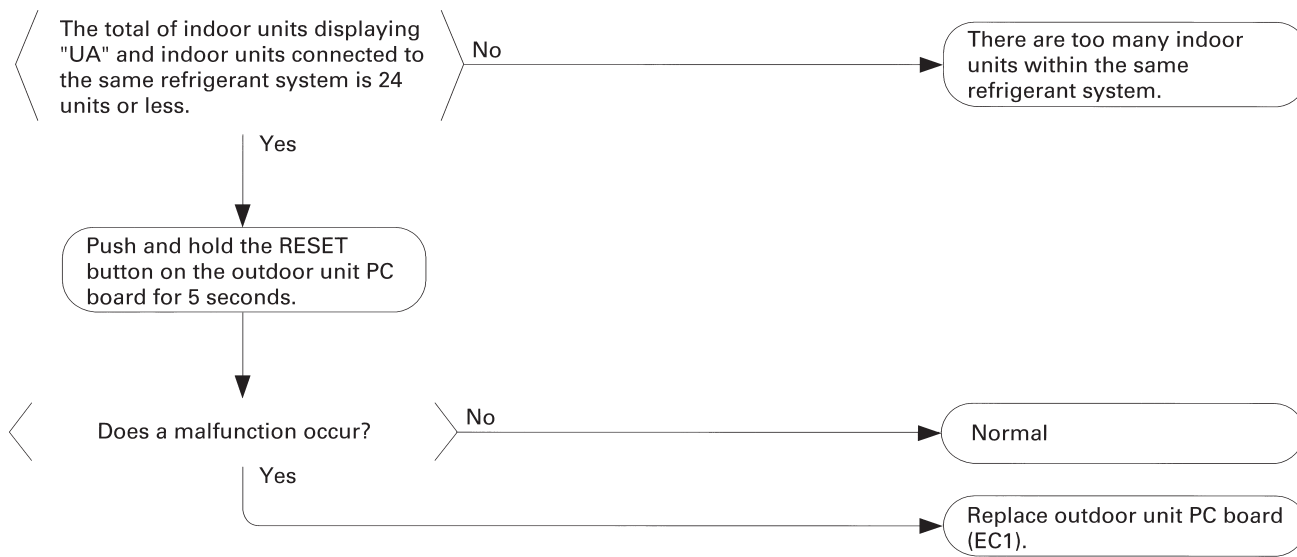

The number of indoor units that can be connected to a single outdoor unit system depends on the type of outdoor unit.

- RSXY 5K : Max. 8 units
- RSXY 8K : Max. 13 units
- RSXY10K : Max. 16 units

Remote controller display
Malfunction code "UC" blinks.

Cause of malfunction

- (1) Address duplication of central remote controller
- (2) Defect of indoor unit PC board

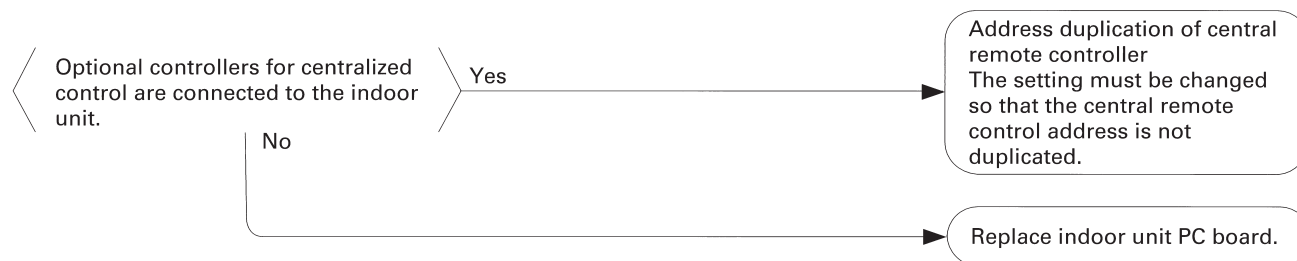



Remote controller display
Malfunction code "UF" blinks.

Cause of malfunction

- (1) Improper connection of transmission wiring between outdoor unit and outdoor unit outside control adaptor
- (2) Failure to execute wiring check operation
- (3) Defect of indoor unit PC board

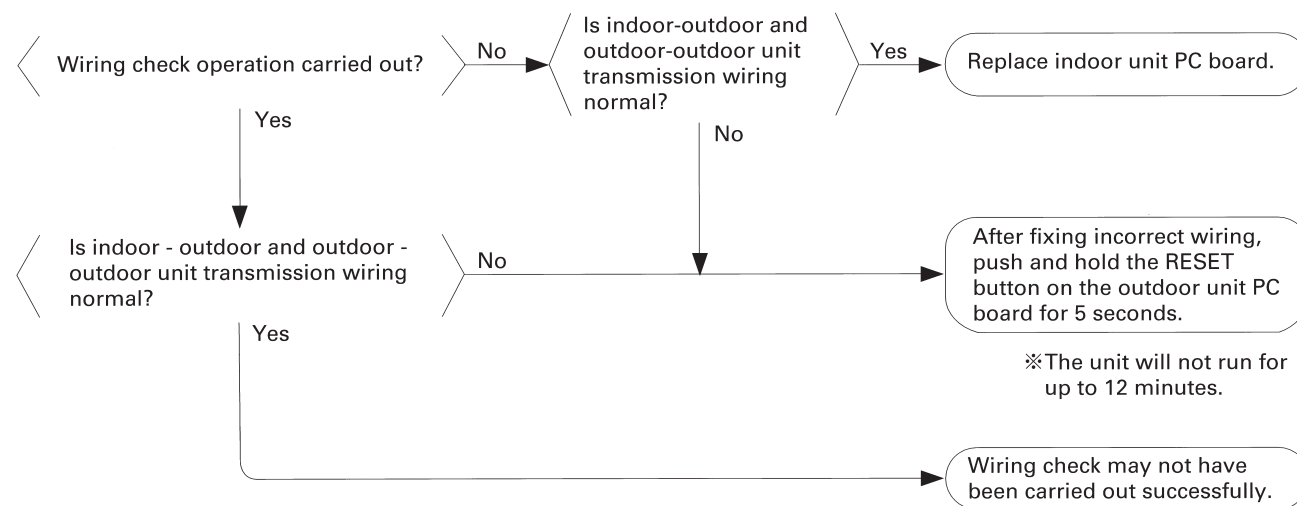

Wiring check may not be successful if carried out after the outdoor unit has been off for more than 12 hours, or if it is not carried out after running all connected indoor units in the fan mode for at least an hour.





**Remote controller display
Malfunction code "UH" blinks.**

Cause of malfunction

- (1) Improper connection of transmission wiring between outdoor unit and outdoor unit outside control adaptor
- (2) Defect of indoor unit PC board
- (3) Defect of outdoor unit PC board (EC1)

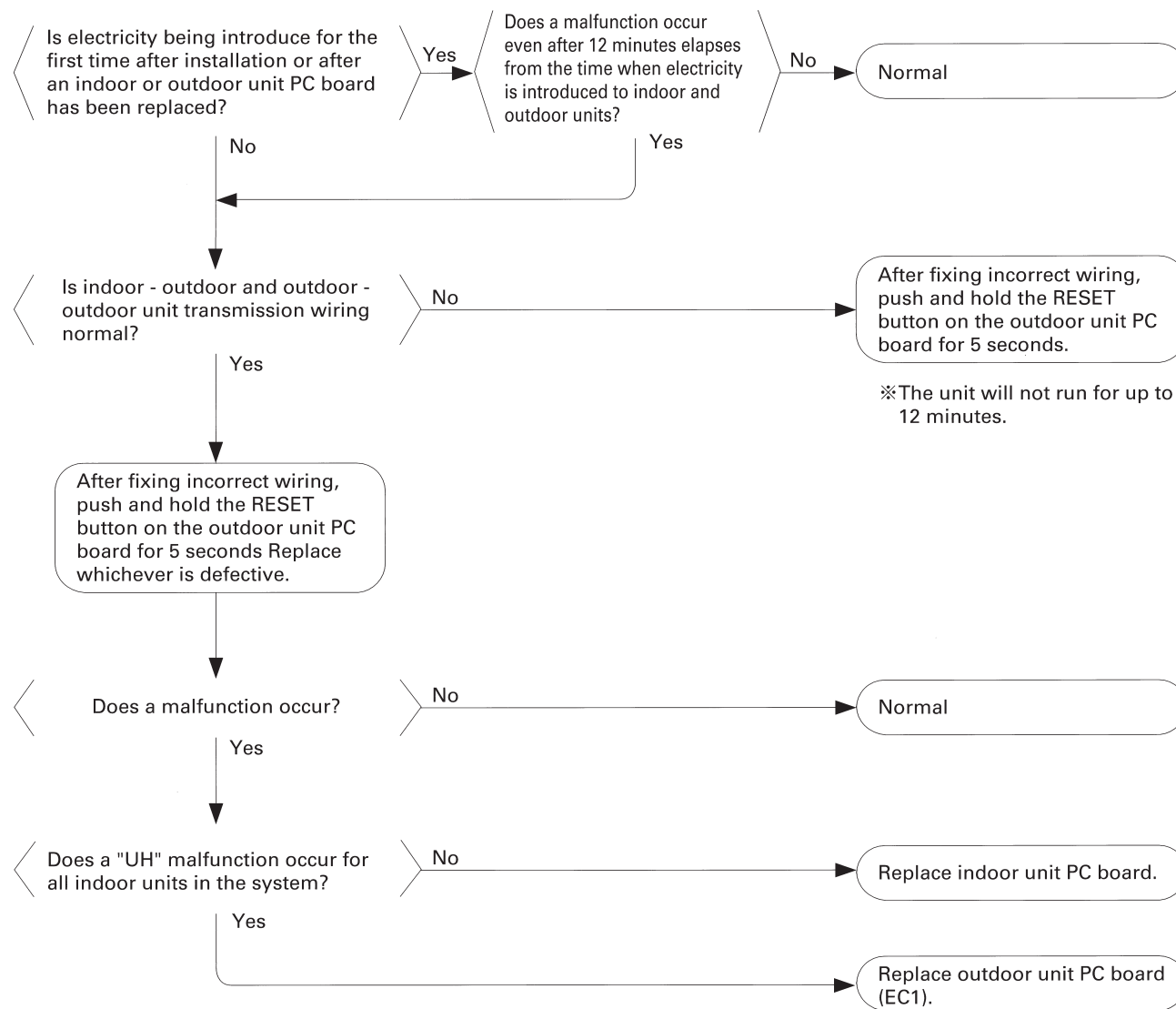

4. Failure Diagnosis for Inverter System

Points of diagnosis

The main causes for each malfunction code are given in the table below. (For details refer to the next page and those following.)

- ◎ : Failure is probable
- : Failure is possible
- △ : Failure is improbable
- : Failure is impossible

Malfunction code	Contents of malfunction	Location of failure							Point of diagnosis
		Inverter		Compressor	Refrigerant system	Outdoor unit PC board	Other	Field cause	
		PC board power unit	Other						
L4	Radiator fin temperature rise	△	◎	—	—	—	—	△	Is the intake port of the radiator fin clogged?
L5	Instantaneous over-current	○	—	◎	△	—	—	—	Inspect the compressor.
L8	Electronic thermostat	△	—	◎	○	—	—	—	Inspect the compressor and refrigerant system.
L9	Stall prevention	△	—	○	◎	—	—	—	Inspect the compressor and refrigerant system.
LC	Malfunction of transmission between inverter PC board and outdoor unit PC board	○	◎	—	—	△	—	—	Inspect the connection between the inverter PC board and outdoor unit PC board. Next, inspect the inverter PC board.
U2	Insufficient current/voltage	○	○	—	—	—	△	◎	<ul style="list-style-type: none"> ● Inspect the fuse on the inverter PC board. ● Check the DC voltage.
P1	Over-ripple protection	○	○	—	—	—	—	○	<ul style="list-style-type: none"> ● Open phase ● Current/voltage imbalance ● Defect of main circuit wiring
P4	Defect of radiator fin temperature sensor	○	△	—	—	—	—	—	Inspect the radiator fin thermistor.



5. How to use the Monitor switch on the Inverter PC Board

The monitor lets you know the contents of the latest stop due to malfunction by LED display on the inverter PC Board. The inverter is equipped with a retry function that retries operation each time stop due to malfunction occurs, and malfunction is therefore not ascertained by merely entering the five minutes standby while retry is attempted the prescribed number of times. If the number of retry times is exceeded within 60 minutes, malfunction is ascertained, and the corresponding malfunction code is displayed on the indoor unit remote controller.

LED	A	1	2	3	4	Malfunction contents	Retry times
	◐	●	●	●	●	Normal	
	◐	●	●	●	○	Malfunction of fin thermistor	3
	◐	○	○	●	●	Sensor malfunction	0
	◐	○	●	●	○	Insufficient voltage	3
	◐	●	●	○	●	Instantaneous over-current	3
	◐	●	○	○	○	Electronic thermistor	3
	◐	○	○	○	○	Stall prevention	3
	◐	●	○	●	●	Open phase detection	3
	●	●	●	●	●	Malfunction of microcomputer	Unlimited

- ◐ : Blink
- : On
- : Off



Remote controller display

Malfunction code "L4" blinks.

Cause of malfunction

- (1) Actuation of fin thermal (Actuates at min. 90°C and resets at max. 80°C)
- (2) Defect of inverter PC board
- (3) Defect of fin thermistor

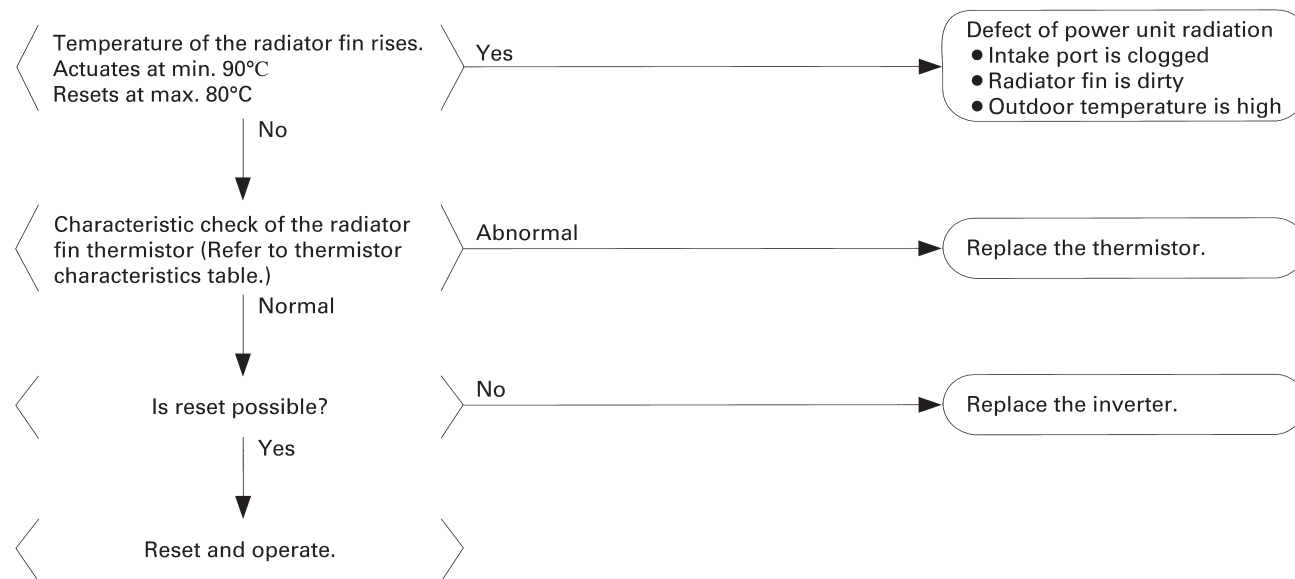



**Remote controller display
Malfunction code "L5" blinks.**

Cause of malfunction

- (1) Defect of compressor coil (disconnected, defective insulation)
- (2) Compressor start-up malfunction (mechanical lock)
- (3) Defect of inverter unit

Compressor inspection

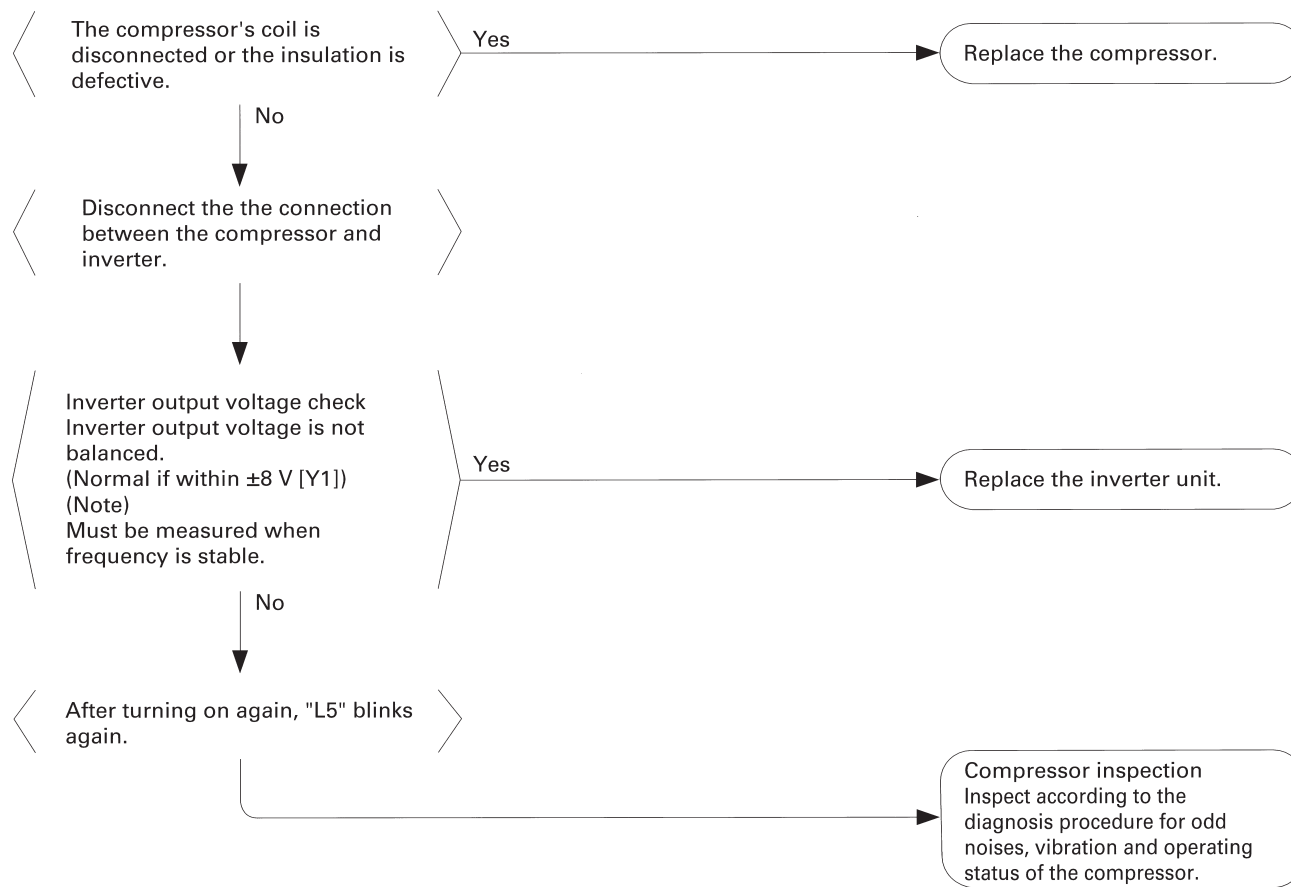



**Remote controller display
Malfunction code "L8" blinks.**

Cause of malfunction

- (1) Compressor overload
- (2) Compressor coil disconnected
- (3) Defect of inverter unit

Output current check

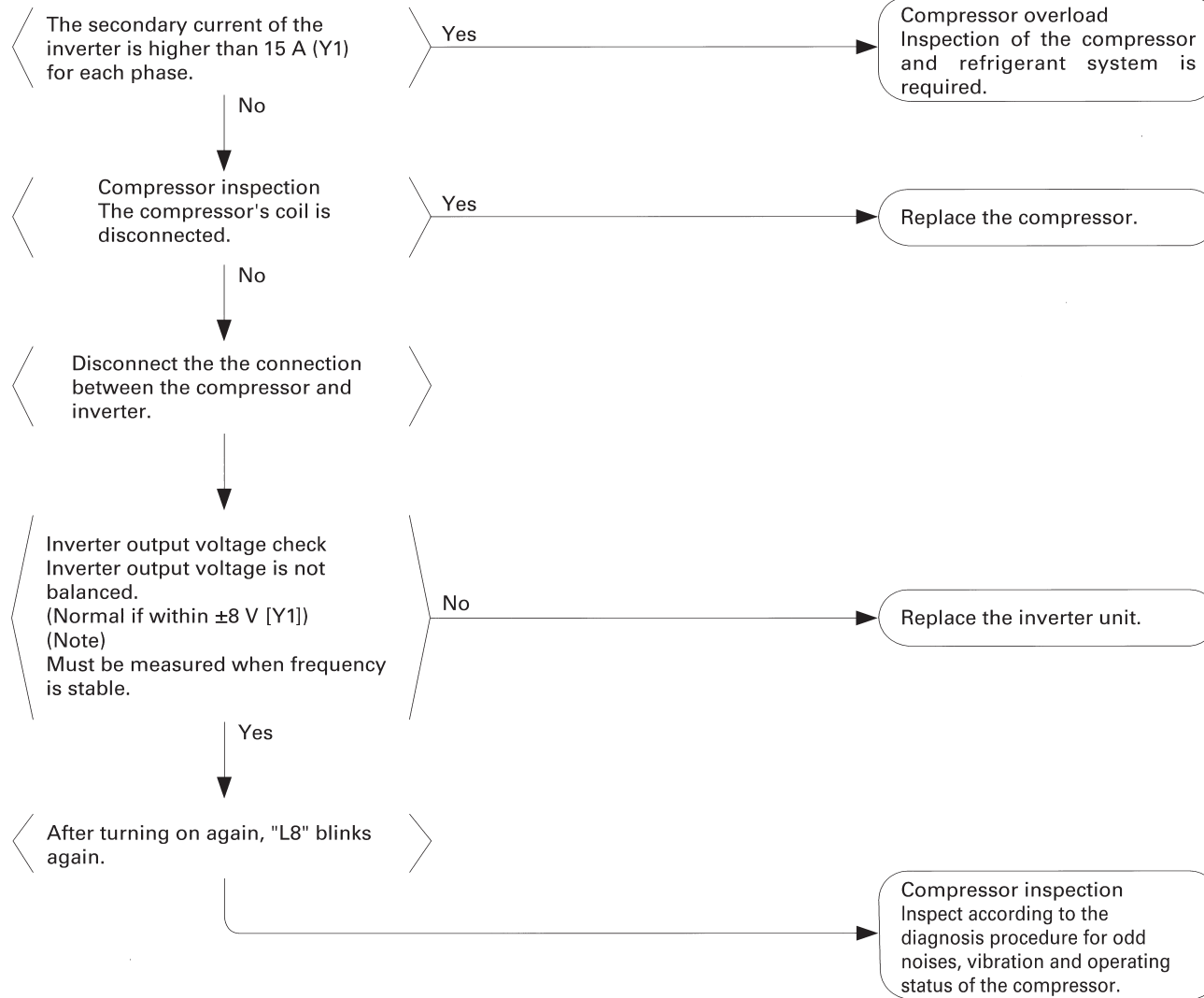



**Remote controller display
Malfunction code "L9" blinks.**

Cause of malfunction

- (1) Defect of compressor
- (2) Pressure differential start
- (3) Defect of inverter unit

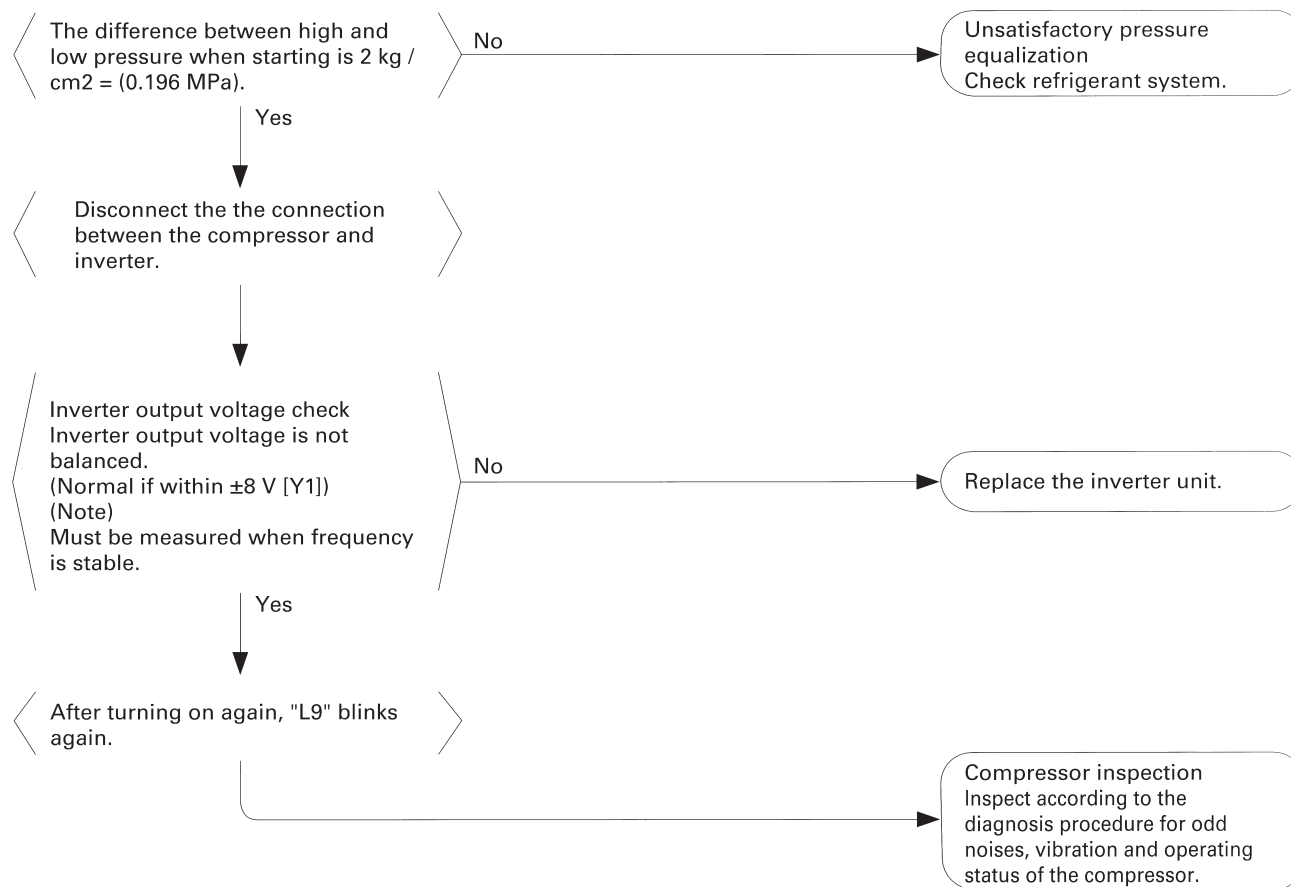



Remote controller display

Malfunction code "LC" blinks.

Cause of malfunction

- (1) Malfunction of connection between the inverter unit and outdoor unit PC board
- (2) Defect of outdoor unit PC board (transmission section)
- (3) Defect of inverter unit
- (4) Defect of noise filter (NF1)

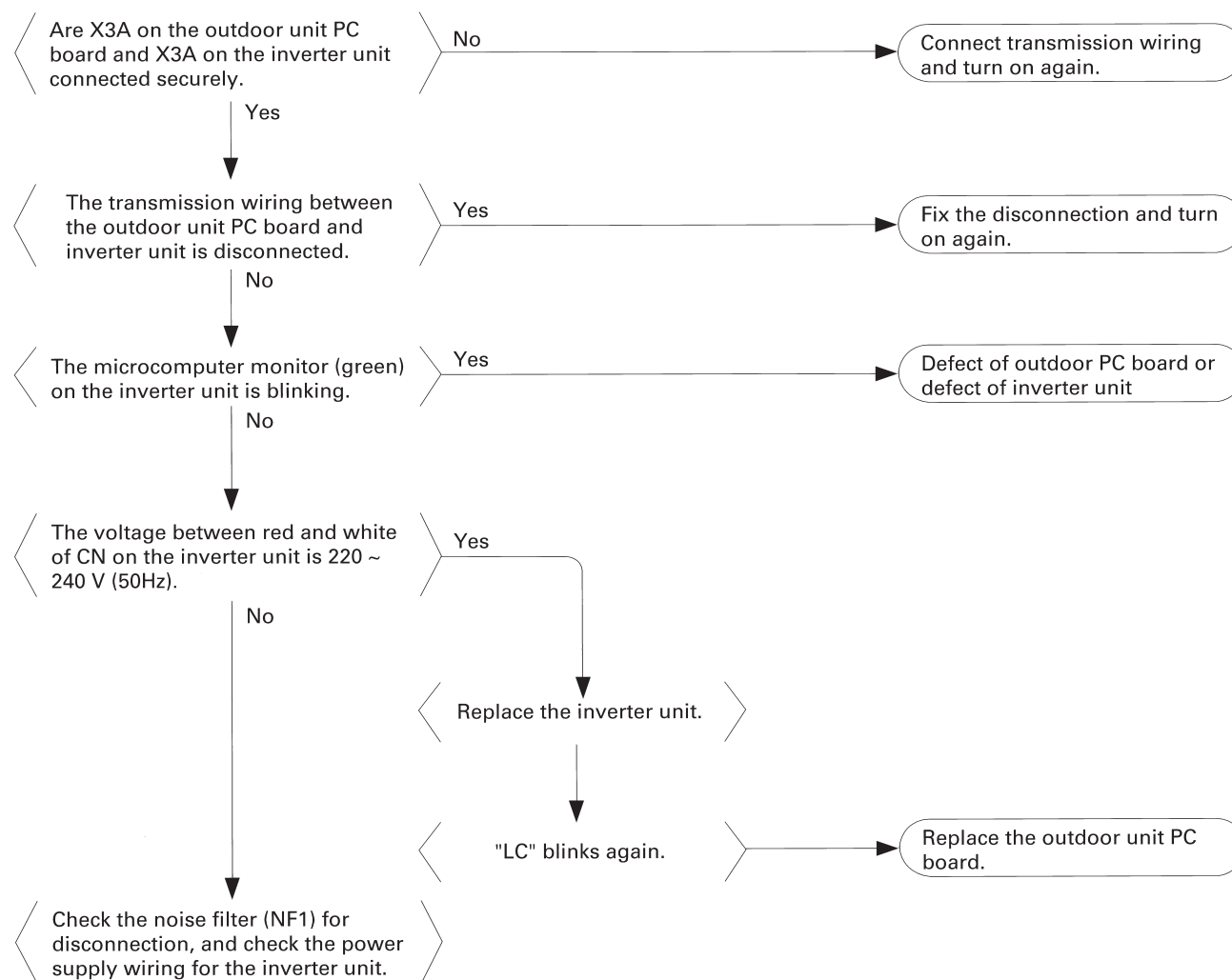

**Remote controller display
Malfunction code "U2" blinks.**

Cause of malfunction

- (1) Power supply insufficient
- (2) Instantaneous failure
- (3) Open phase
- (4) Defect of inverter unit
- (5) Defect of outdoor PC board
- (6) Defect of K1M.
- (7) Main circuit wiring defect

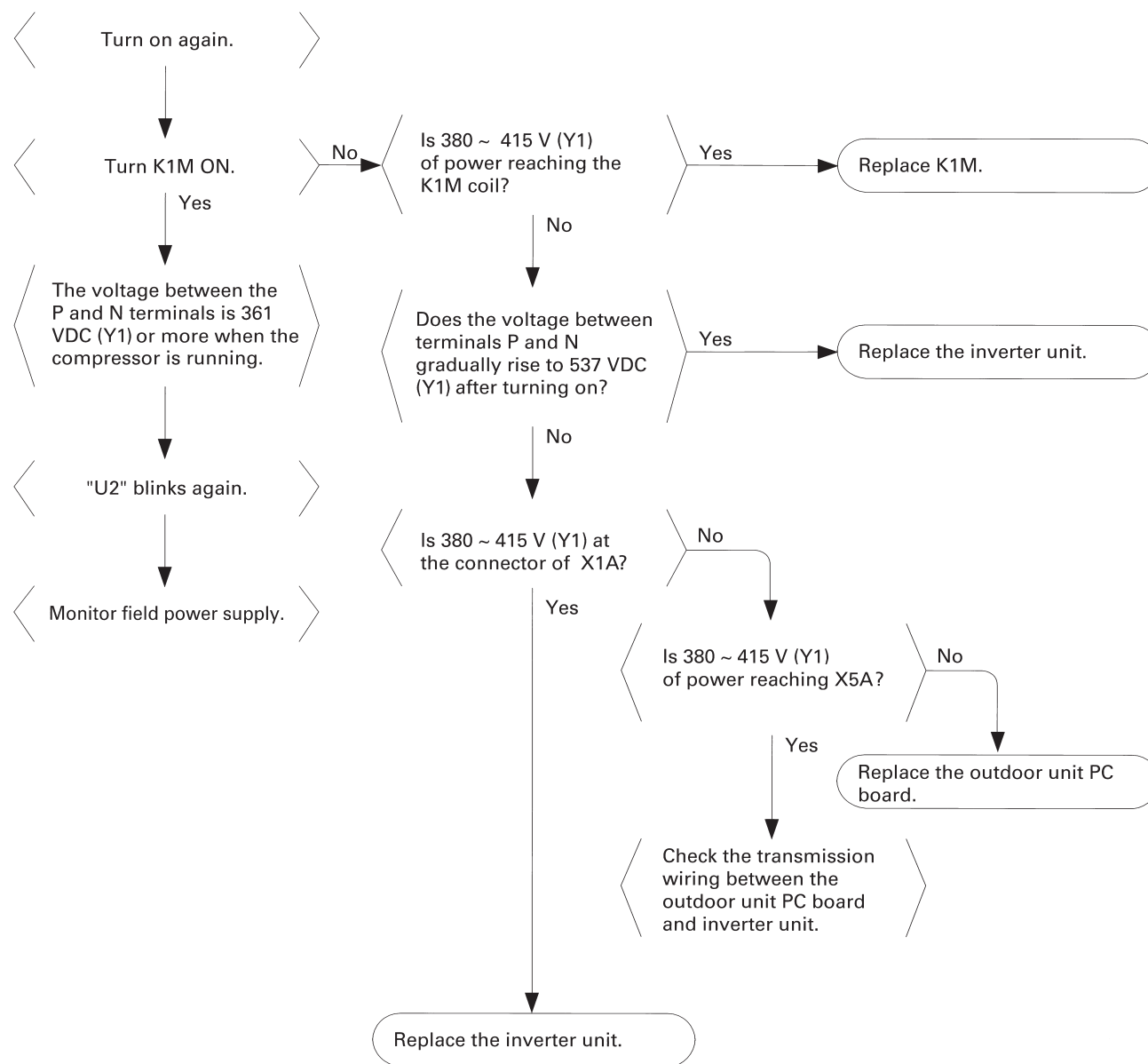

**Remote controller display
Malfunction code "P1" blinks.**

Cause of malfunction

- (1) Open phase
- (2) Voltage imbalance between phases
- (3) Defect of main circuit capacitor
- (4) Defect of inverter unit
- (5) Defect of K1M
- (6) Improper main circuit wiring

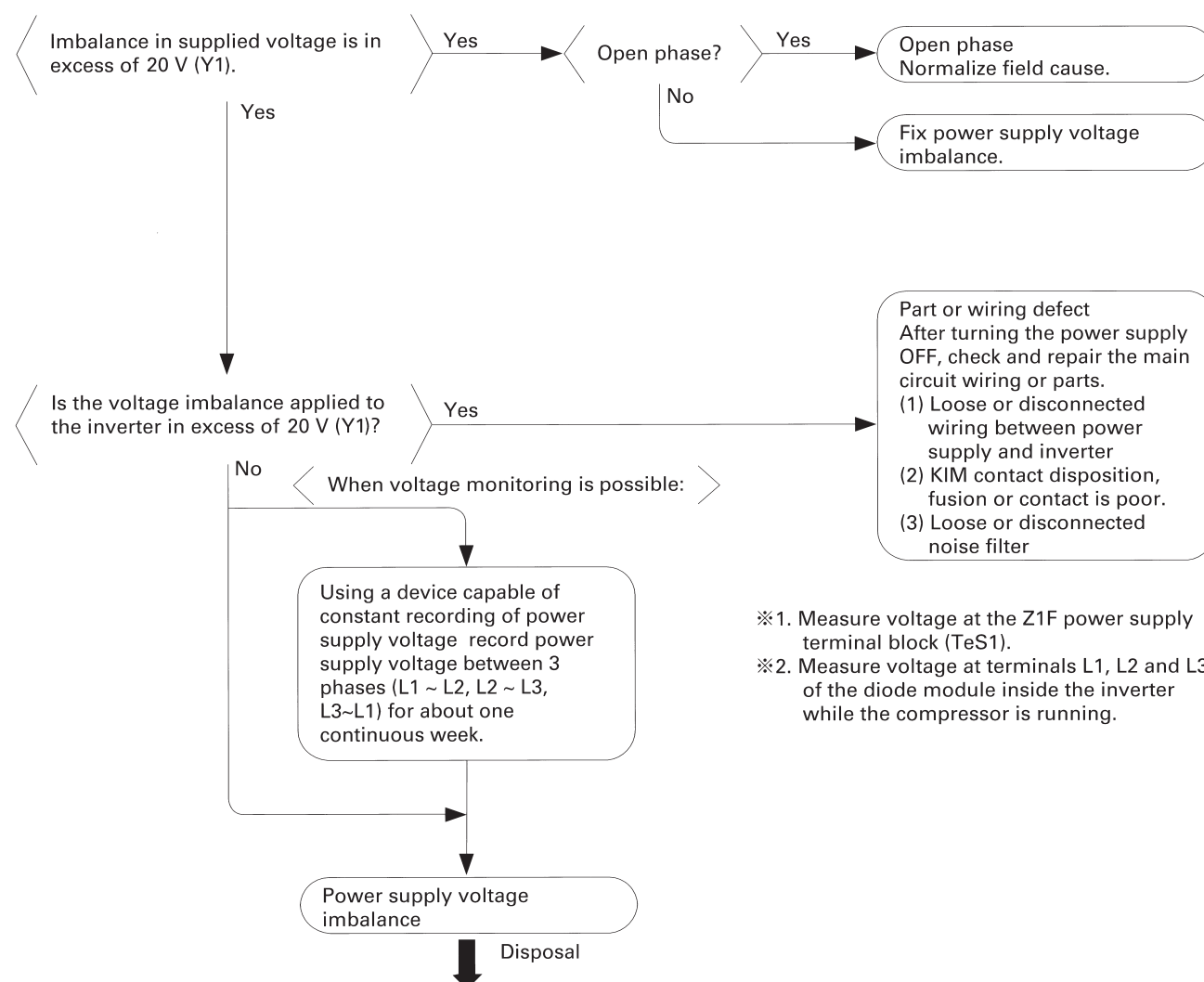

- ※1. Measure voltage at the Z1F power supply terminal block (TeS1).
- ※2. Measure voltage at terminals L1, L2 and L3 of the diode module inside the inverter while the compressor is running.

Explanation for users ※In accordance with "notification of inspection results" accompanying spare parts.

Give the user a copy of "notification of inspection results" and leave it up to him to improve the imbalance.

Be sure to explain to the user that there is a "power supply imbalance" for which DAIKIN is not responsible.

Contact QC div.

Be sure to send a product report of the imbalance.



Remote controller display
Malfunction code "P4" blinks.

Cause of malfunction

- (1) Defect of radiator fin temperature sensor
- (2) Defect of inverter unit

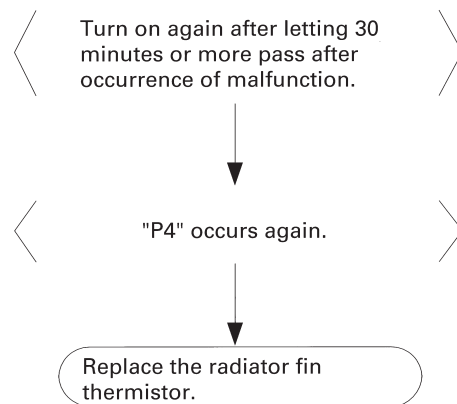

6. Failure Diagnosis for Central Remote Controller (1/4)

Malfunction 1: Liquid crystal operation monitor and "UE" blink.

Cause of malfunction

- (1) Malfunction of transmission between optional controllers for centralized control and indoor unit
- (2) Connector for setting master controller is disconnected.
- (3) Failure of PC board for central remote controller
- (4) Defect of indoor unit PC board

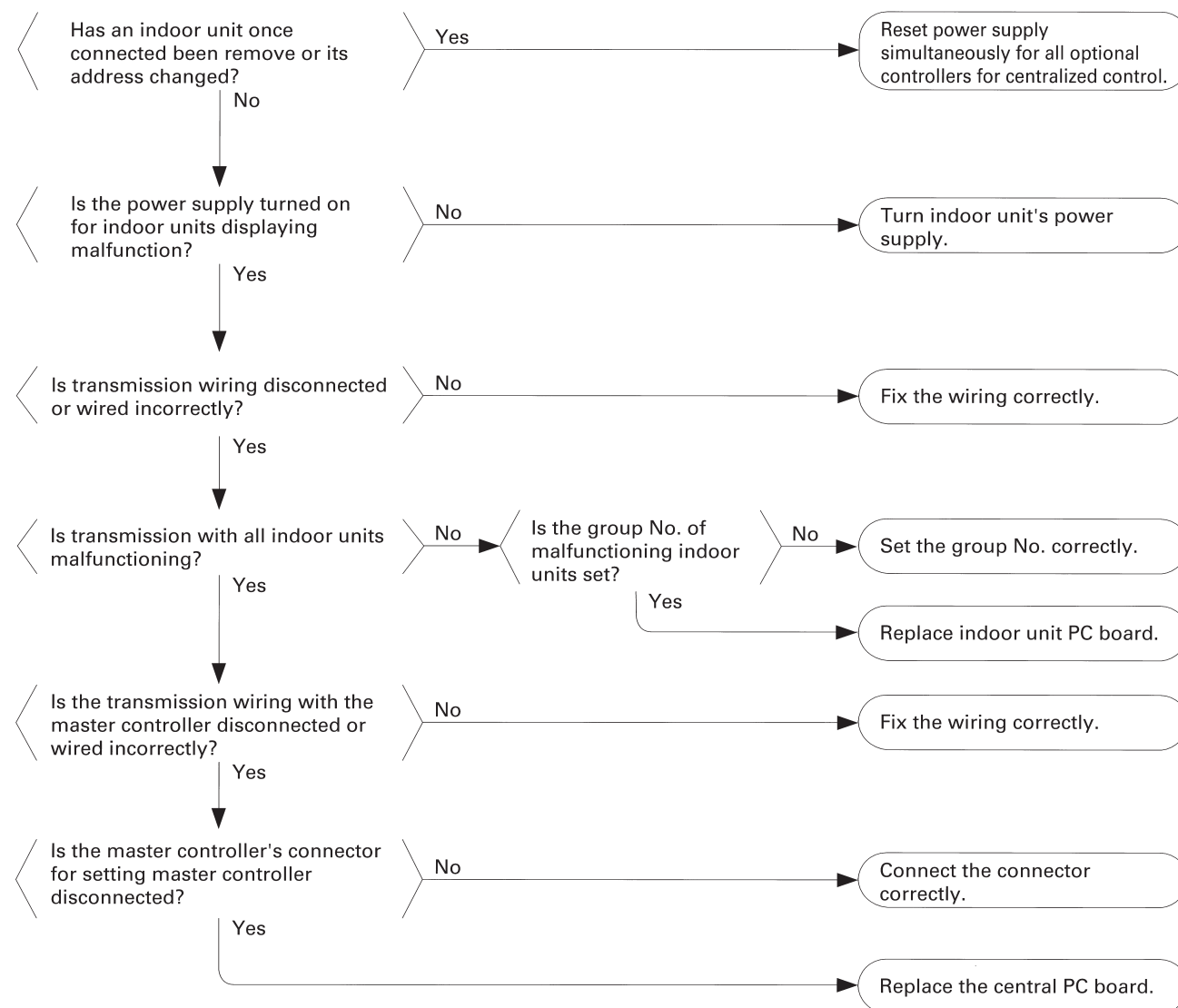



Failure Diagnosis for Central Remote Controller (2/4)

Malfunction 2: Malfunction code "M1" blinks

Cause of malfunction

(1) Defect of central remote controller PC board

Replace the central remote controller PC board.

Malfunction 3: Malfunction code "M8" blinks.

Cause of malfunction

(1) Malfunction of transmission between optional controllers for centralized control

(2) Defect of PC board of optional controllers for centralized control

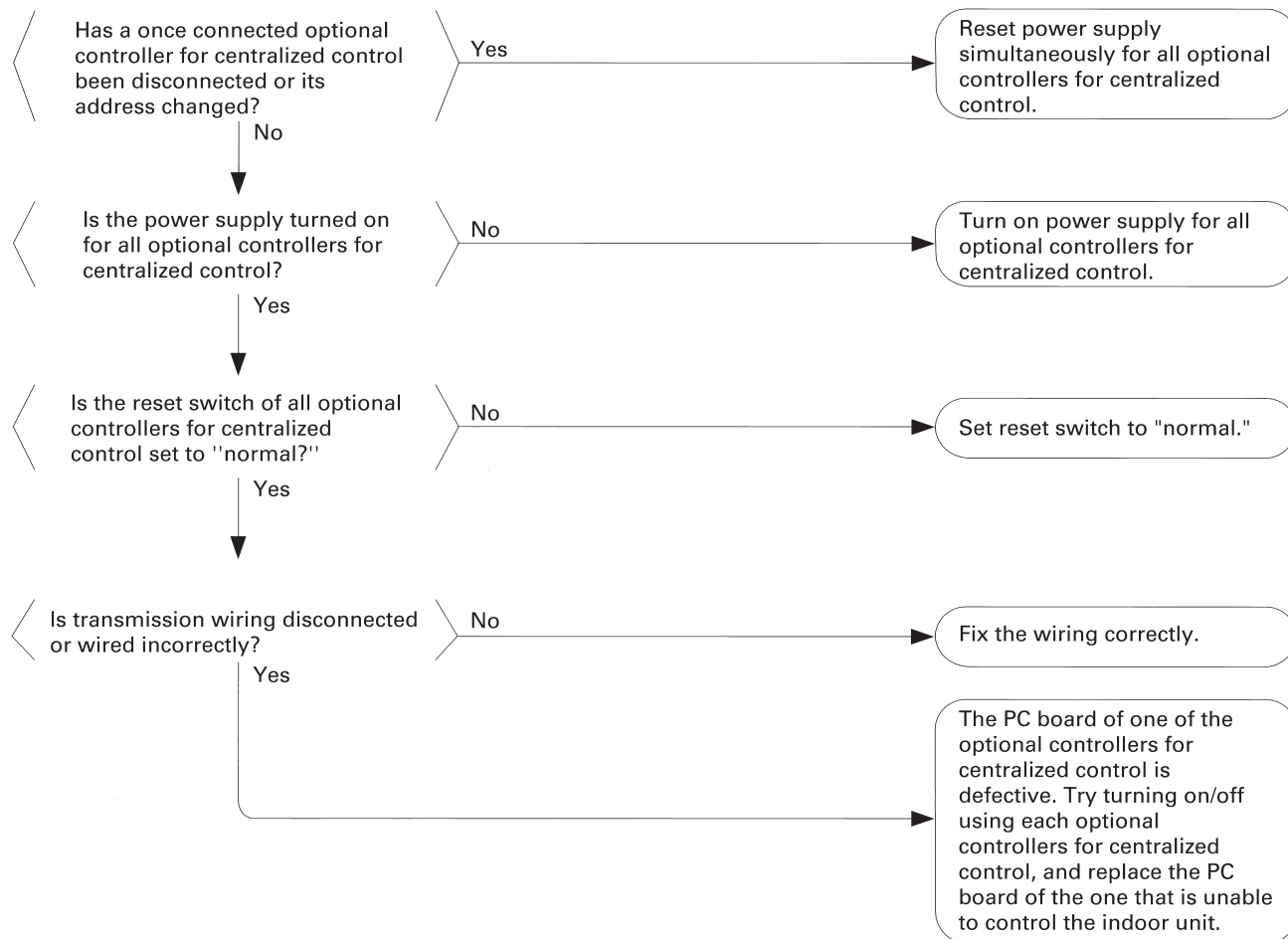

Failure Diagnosis for Central Remote Controller (3/4)

Malfunction 4: Malfunction code "MA" blinks.

Cause of malfunction

- (1) Improper combination of optional controllers for centralized control
- (2) More than one master controller is connected
- (3) Defect of PC board of optional controller for centralized control

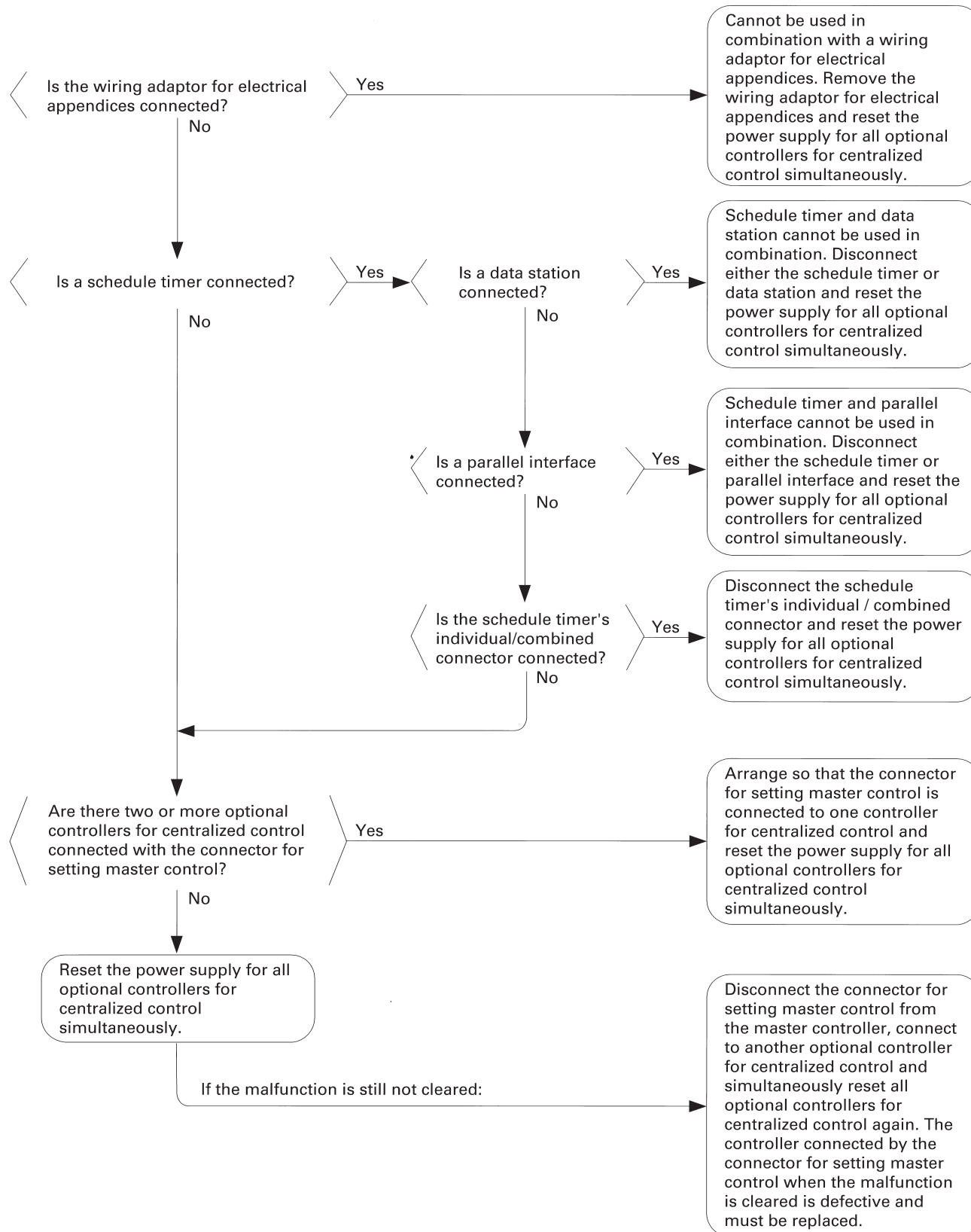



Failure Diagnosis for Central Remote Controller (4/4) Malfunction 5: Malfunction code "MC" blinks.

Cause of malfunction

(1) Address duplication of central remote controller

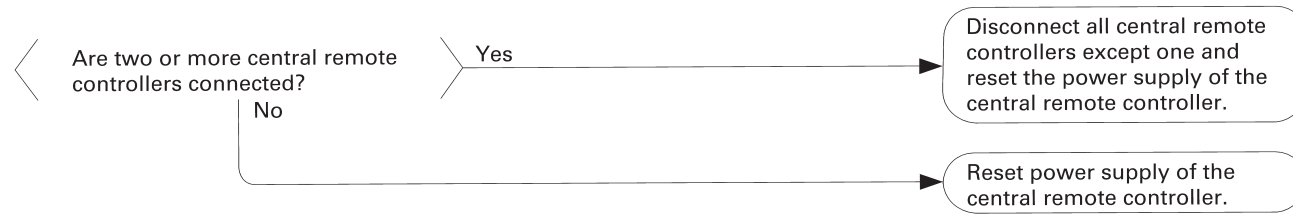

7. Failure Diagnosis for Schedule Timer (1/4)

Malfunction 1: Operation lamp and "UE" blinks.

Cause of malfunction

- (1) Malfunction of transmission between central remote controller and indoor unit
- (2) Disconnection of connector for setting master controller (or individual/combined switching connector)
- (3) Defect of schedule timer PC board
- (4) Defect of indoor unit PC board

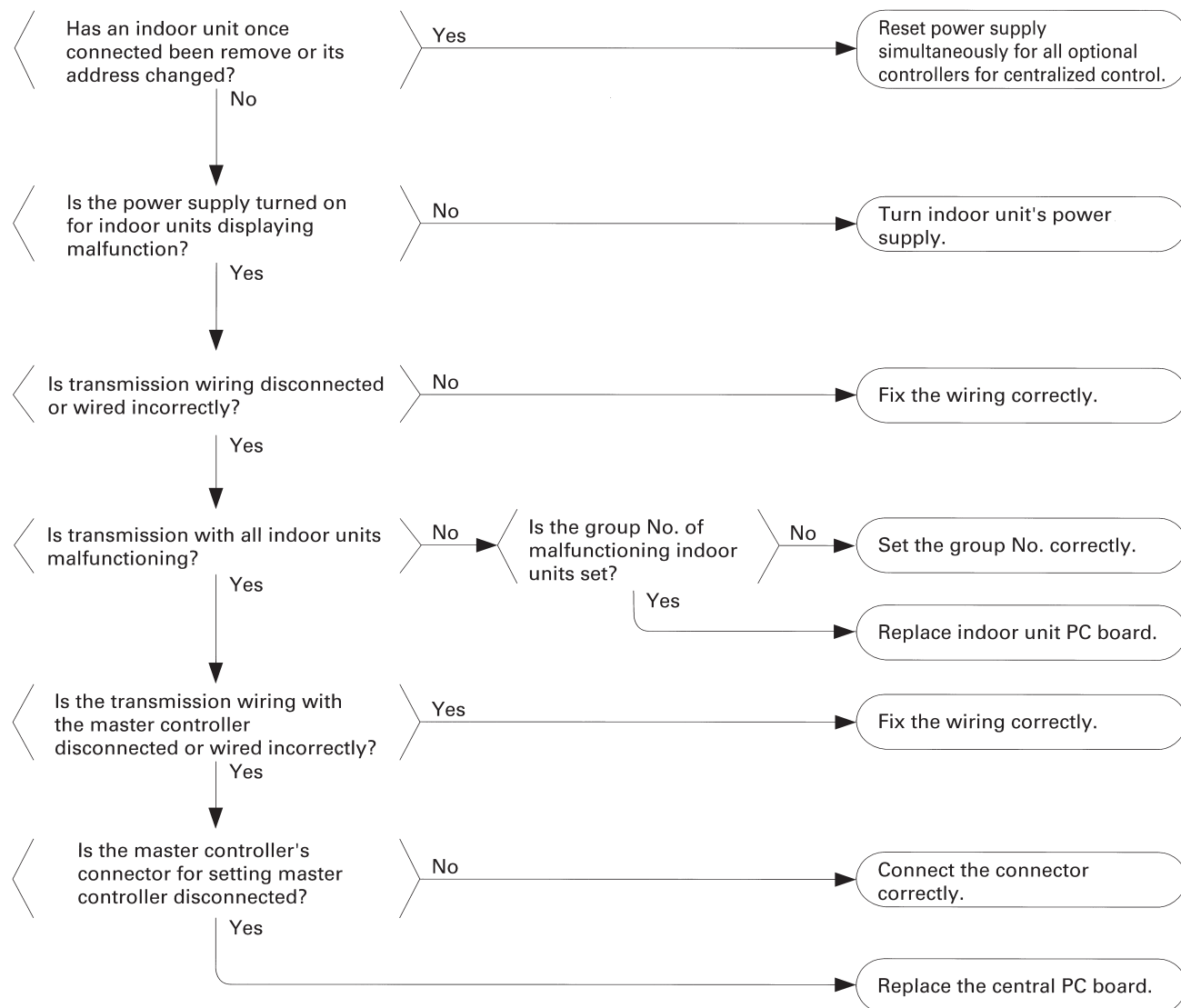



Failure Diagnosis for Schedule Timer (2/4) Malfunction 2: Operation lamp and "M1" blinks.

Cause of malfunction

(1) Defect of schedule timer PC board

Replace the schedule timer PC board.

Malfunction 3: Malfunction code "M8" blinks.

Cause of malfunction

(1) Malfunction of transmission between optional controllers for centralized control

(2) Defect of PC board of optional controllers for centralized control

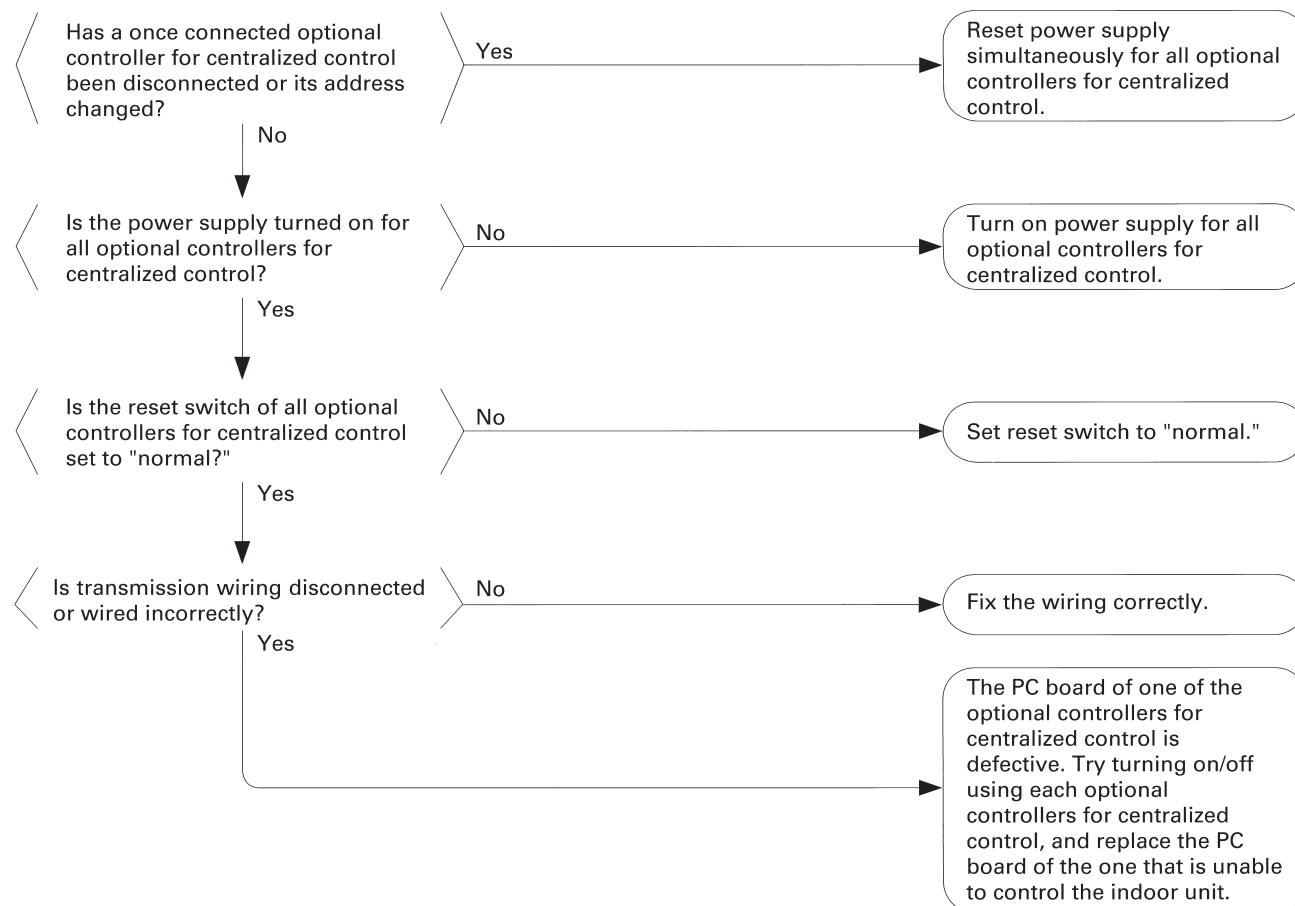

Failure Diagnosis for Schedule Timer (3/4)

Malfunction 4: Malfunction code "MA" blinks.

Cause of malfunction

- (1) Improper combination of optional controllers for centralized control
- (2) More than one master controller is connected.
- (3) Defect of PC board of optional controller for centralized control

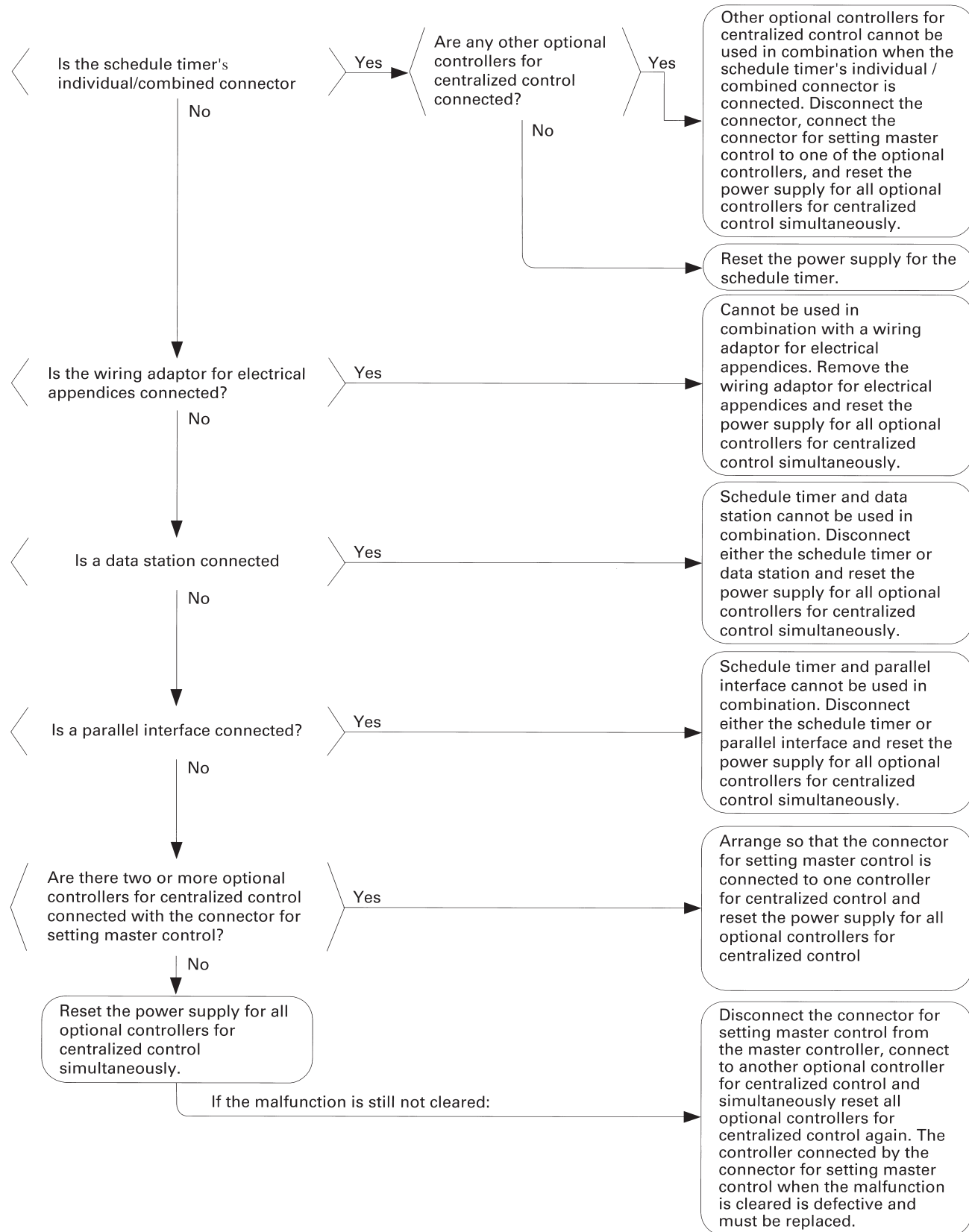



Failure Diagnosis for Schedule Timer (4/4) Malfunction 4: Malfunction code "MC" blinks.

Cause of malfunction

(1) Address duplication of optional controller for centralized control

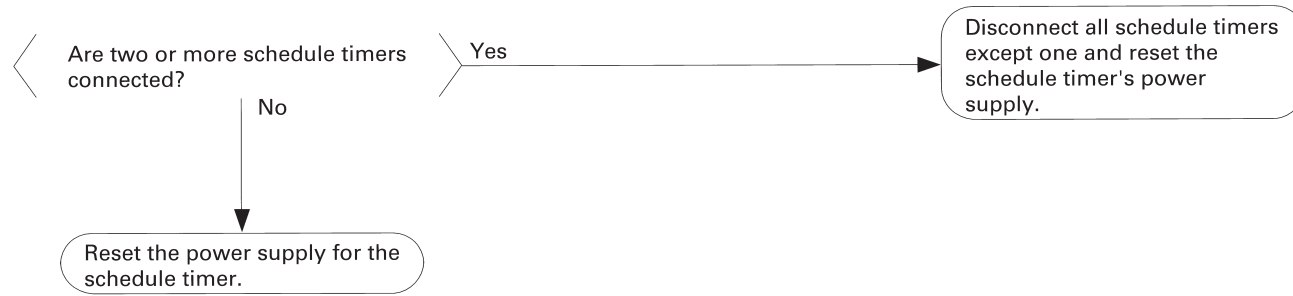

8. Failure Diagnosis for Unified ON/OFF Controller (1/3)

Malfunction 1: Operation lamp blinks

Cause of malfunction

- (1) Malfunction of transmission between optional controller and indoor unit
- (2) Connector for setting master controller is disconnected
- (3) Defect of unified ON/OFF controller
- (4) Defect of indoor unit PC board
- (5) Malfunction of air conditioner

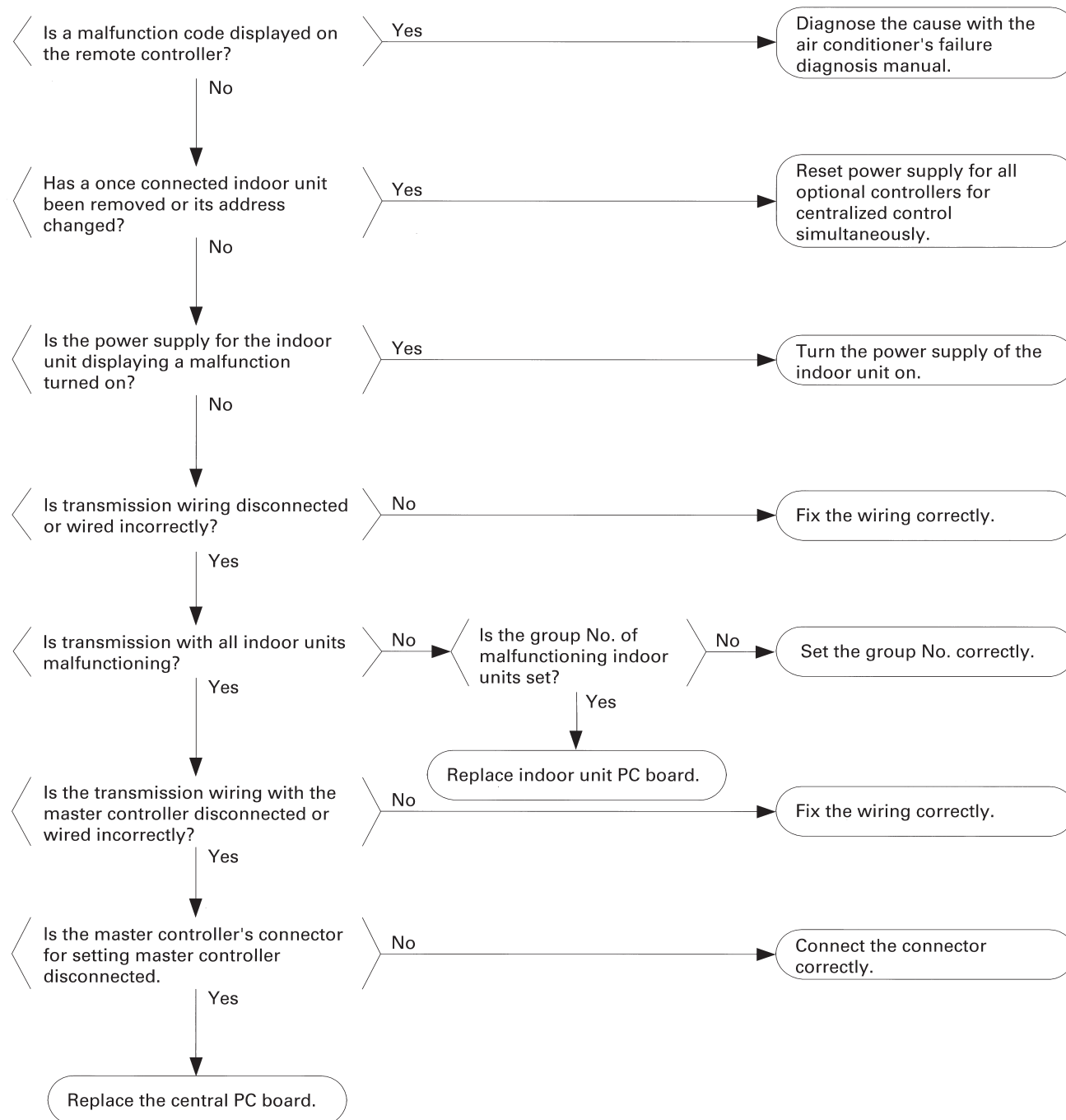



Failure Diagnosis for Unified ON/OFF Controller (2/3)

Malfunction 2: Display "under host computer integrated control" blinks (Repeats single blink)

Cause of malfunction

- (1) Address duplication of central remote controller
- (2) Improper combination of optional controllers for centralized control
- (3) Connection of more than one master controller
- (4) Malfunction of transmission between optional controllers for centralized control
- (5) Defect of PC board of optional controllers for centralized control

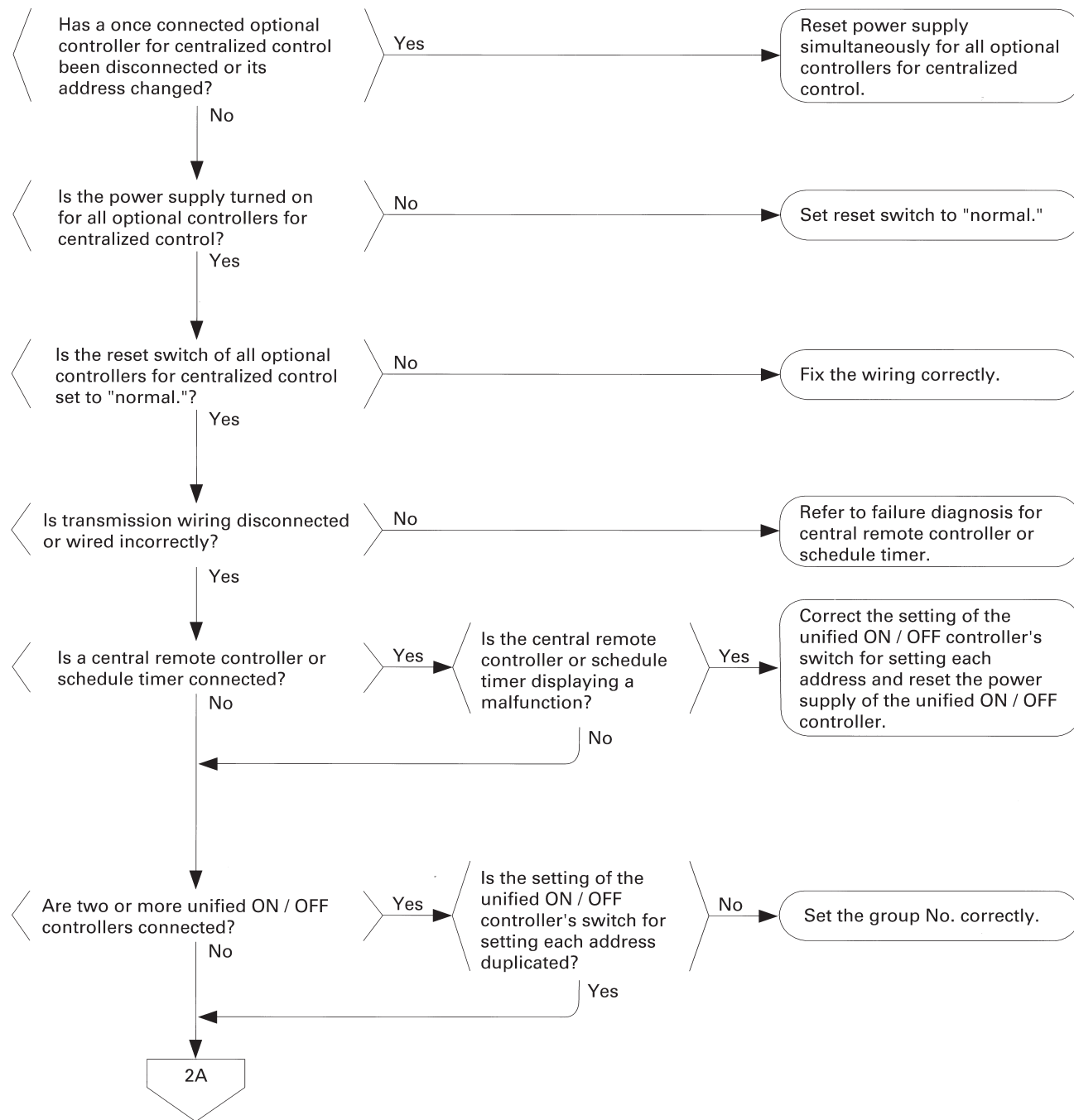

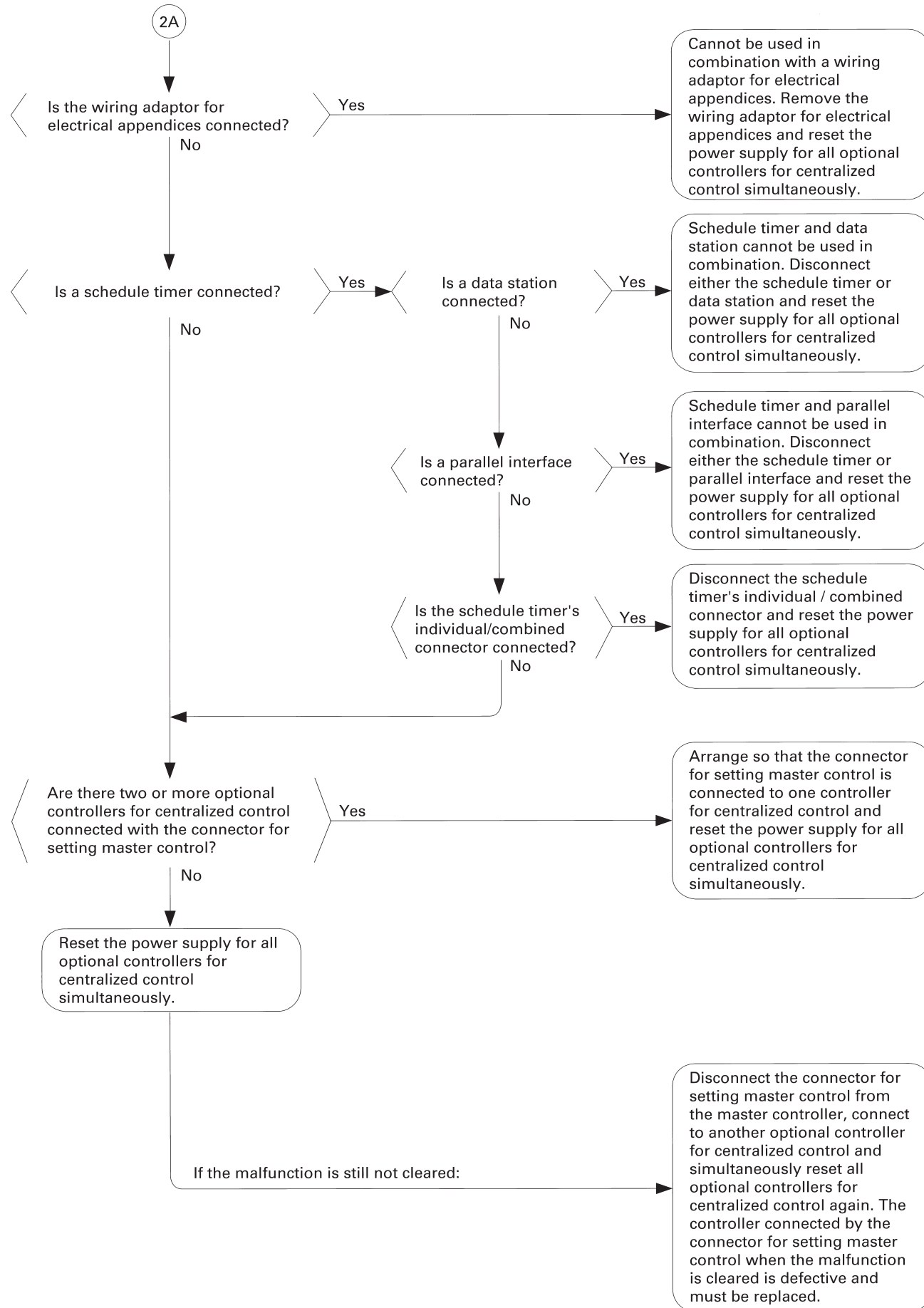



Failure Diagnosis for Unified ON/OFF Controller (3/3)

Malfunction 3: Display "under host computer integrated control" blinks (Repeats double blink)

Cause of malfunction

- (1) Central control address (group No.) is not set for indoor unit.
- (2) Improper address setting
- (3) Improper wiring of transmission wiring

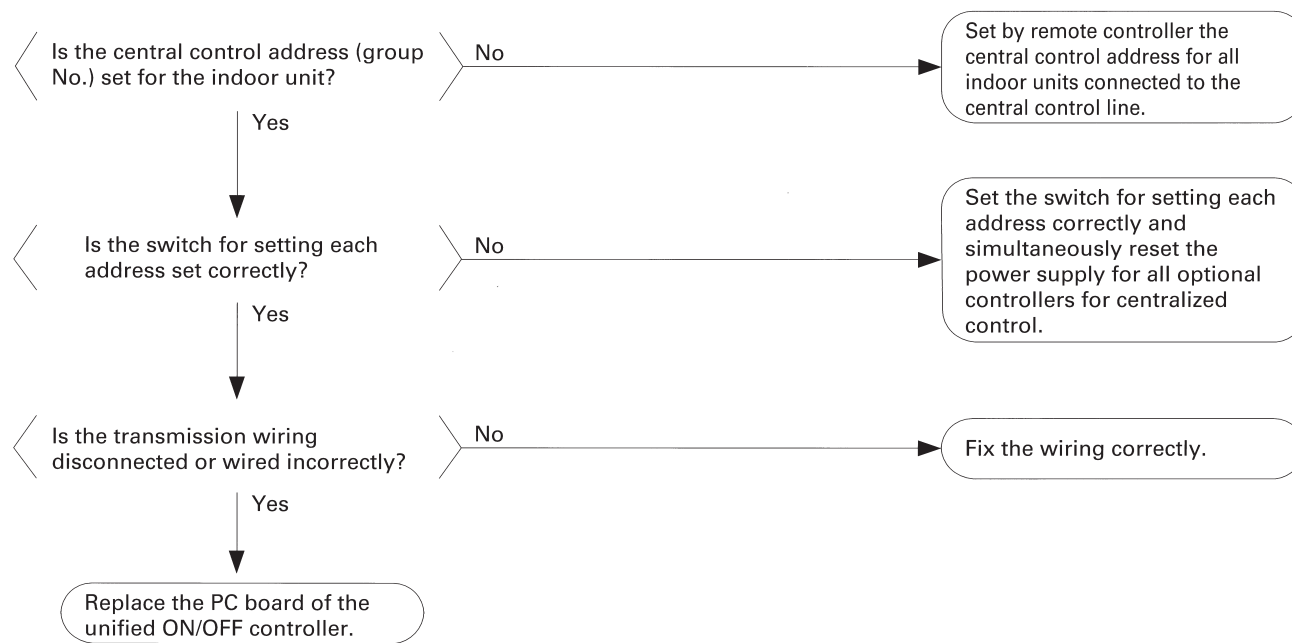



9. Appendix

(1) Precautions When Replacing K Series PC Boards

If you replace the indoor or outside unit PC board, push and hold the RESET button on the outdoor unit PC Board for 5 seconds.

■ In this case, the unit will not run for up to 12 minutes.

Precautions when replacing indoor unit PC board

When replacing the indoor unit PC board, the following contents are factory set. Change the settings if necessary.

1. Field set contents (dirty filter, stop input from outside, etc.)

- Change settings with the remote controller.
- When using group control or setting by individual indoor units, the "indoor unit No." before and after changing the PC board may differ.

Set after checking the indoor unit No.

2. Central address

Change setting with the remote controller.

3. Capacity display

A capacity setting adaptor must be installed for all models.

※ Fan phase control is for FXYF, FXYH, FXYA only.

■ Precautions when replacing outdoor unit PC board

When replacing the outdoor unit PC board, set the following settings again.

1. Field set contents (setting mode 1)

Set cool/heat selection, low noise and sequential start again.

2. Setting mode 2

Change the TC setting, TE setting and defrost setting as required.

(2) Precautions Concerning the Remote Controller's Mode No.

Mode numbers that are not in the list but can be set may be displayed by the remote controller. Do not change settings not included in the list. If so, we may not be able to guarantee operation.





(3) Typical Wiring Mistakes

(1) One of the indoor units is connected to outdoor-to-outdoor transmission terminals

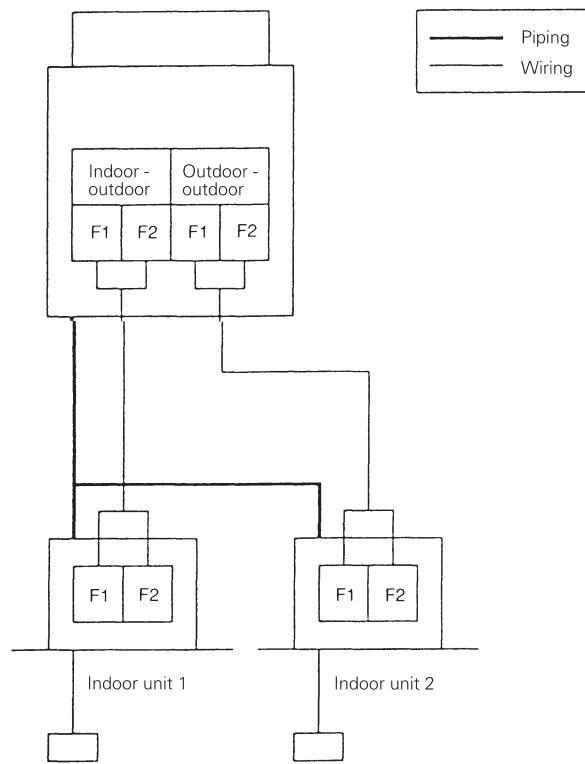

Installation / test operation

Indoor unit 1	Normal
Indoor unit 2	UF malfunction

Other

Indoor unit 1	Normal
Indoor unit 2	U4 malfunction or no malfunction display

(2) All indoor units connected to the outdoor-to-outdoor unit terminal

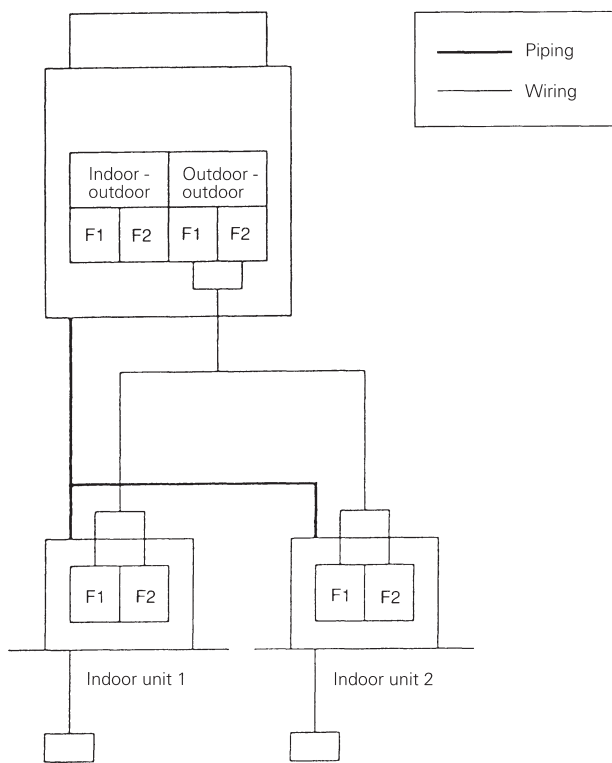

Installation / test operation

Indoor unit 1	UF malfunction
Indoor unit 2	

Other

Indoor unit 1	U4 malfunction or no malfunction display
Indoor unit 2	





(3) All indoor units connected to Indoor-to-outdoor and outdoor-to-outdoor unit terminals

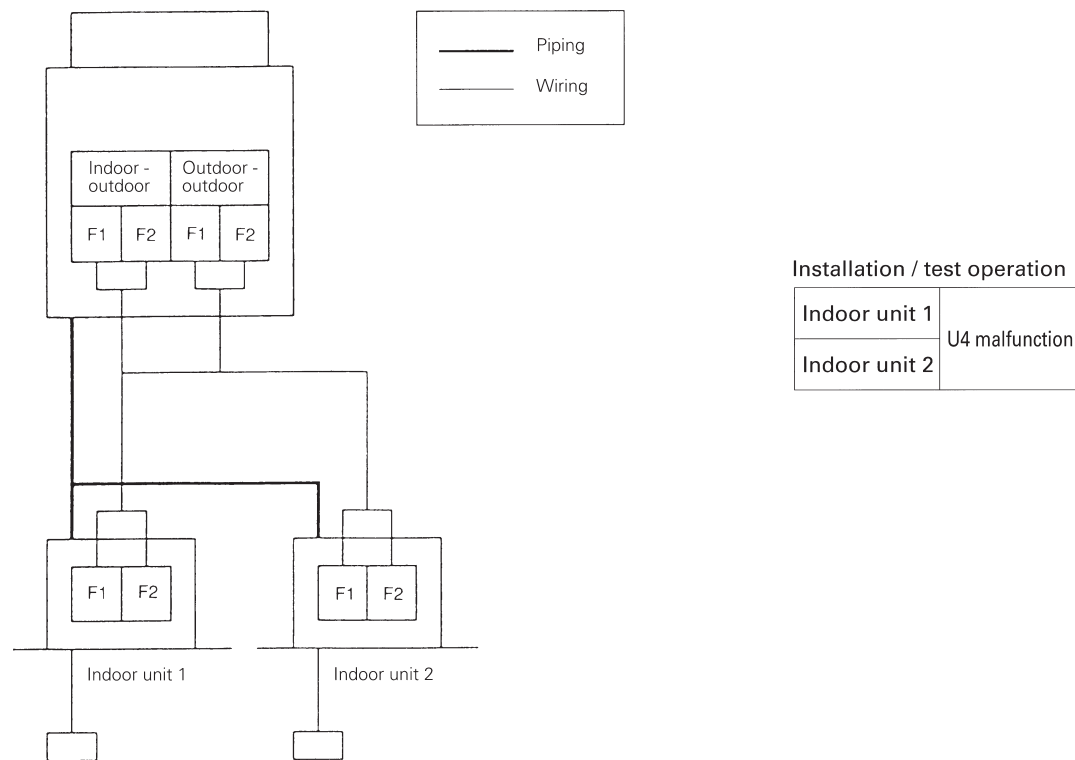

(4) Extended indoor unit

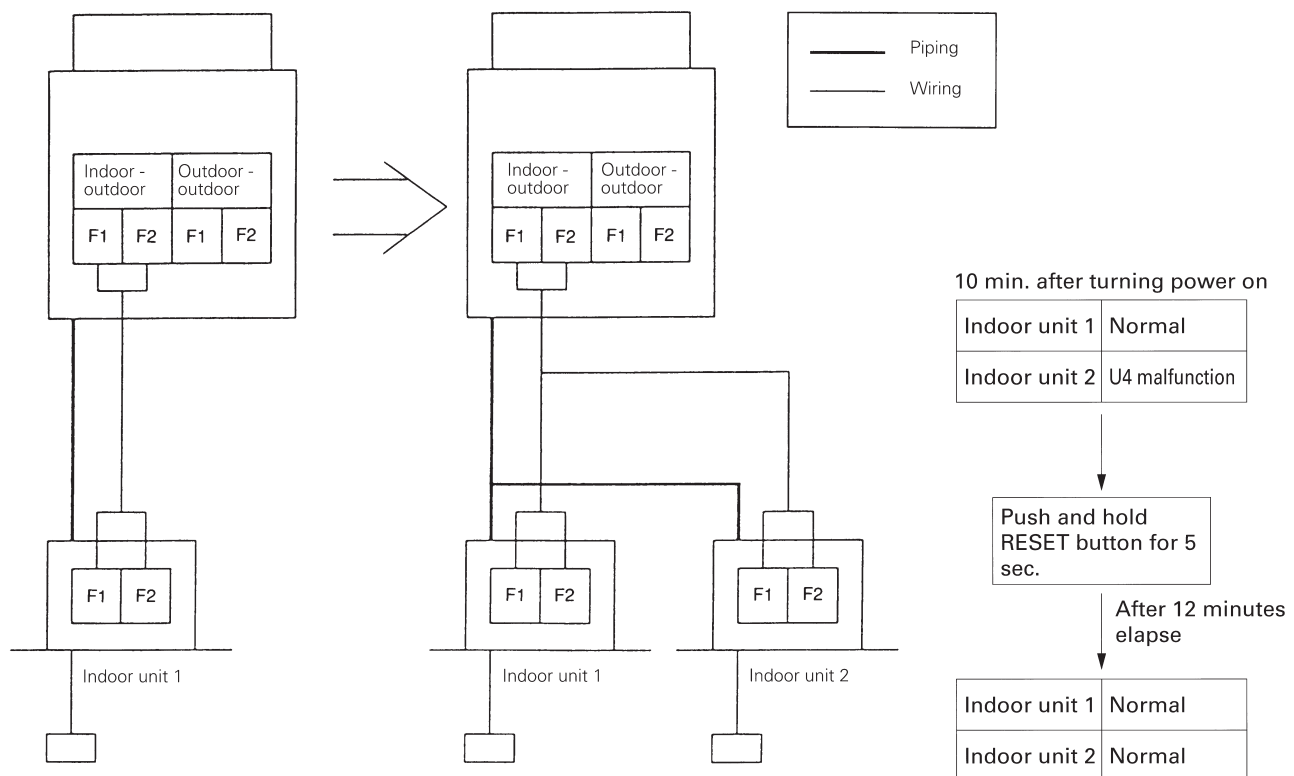



(5) One of the indoor units of outdoor unit 1 is connected to outdoor-to-outdoor transmission terminals

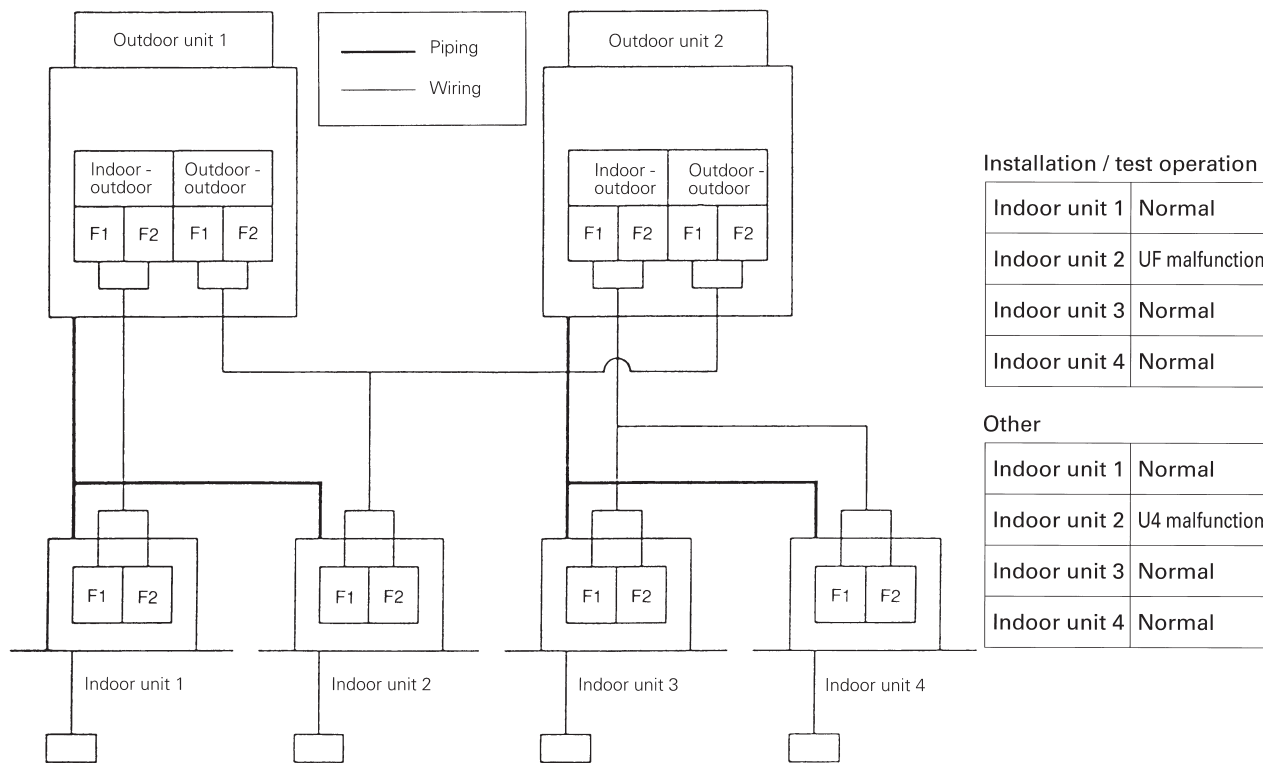

(6) The indoor-to-outdoor terminal of outdoor unit 1 and the outdoor-to-outdoor terminal of outdoor unit 2 are connected

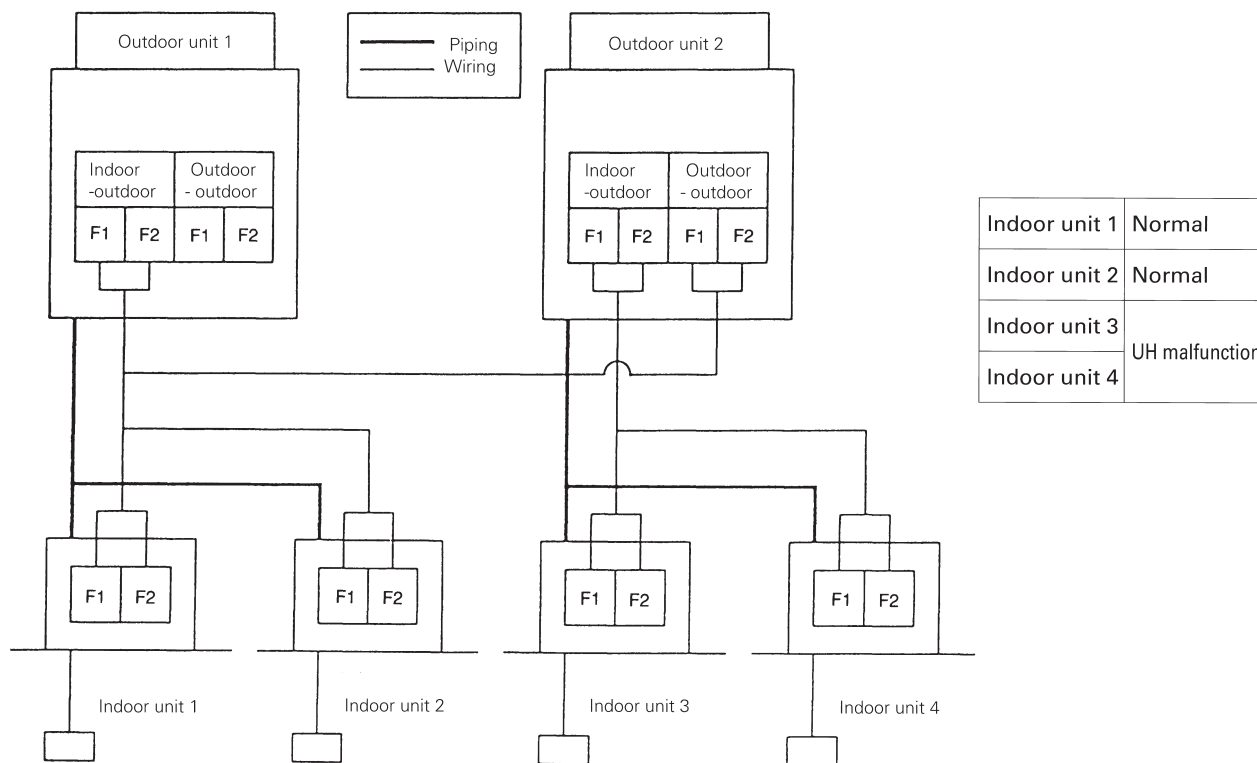



(7) The indoor-to-outdoor terminals of outdoor units 1 and 2 are connected

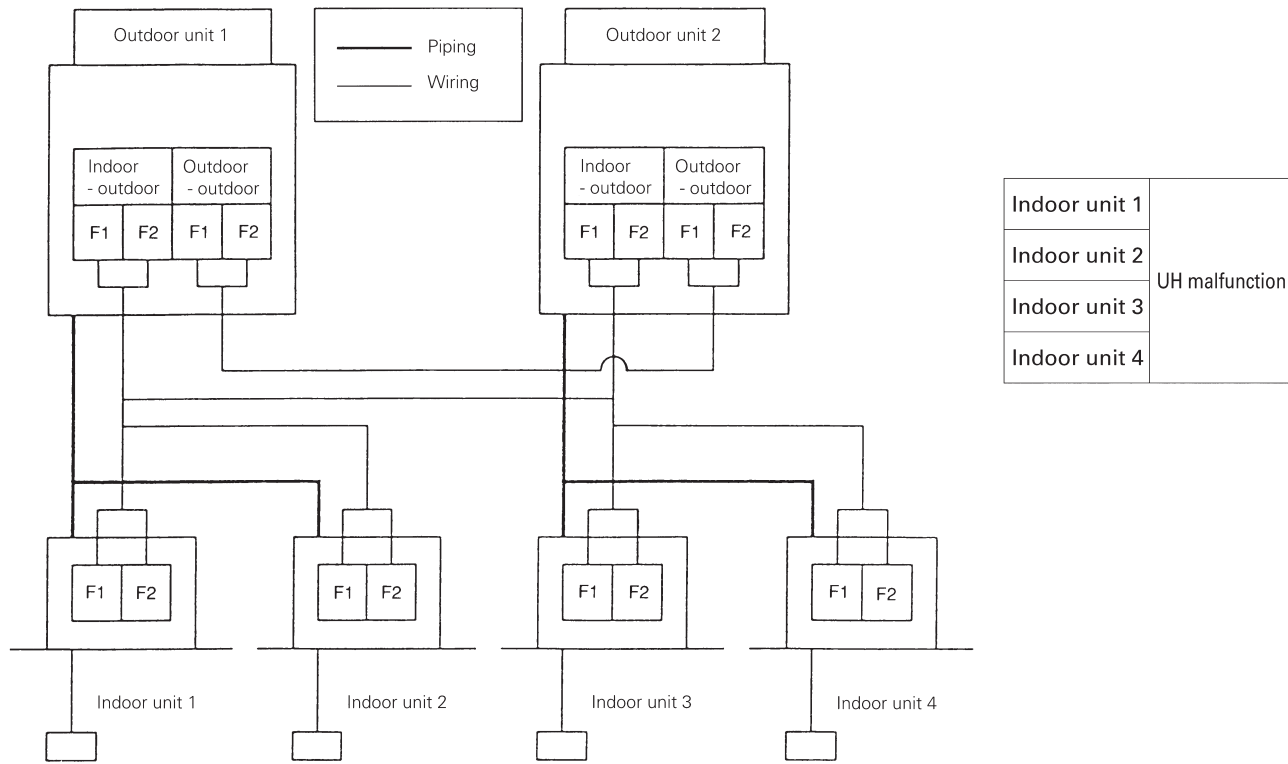



(4) Wiring diagrams

(1) Inverter Series (Heat pump) [50Hz 380~415V]

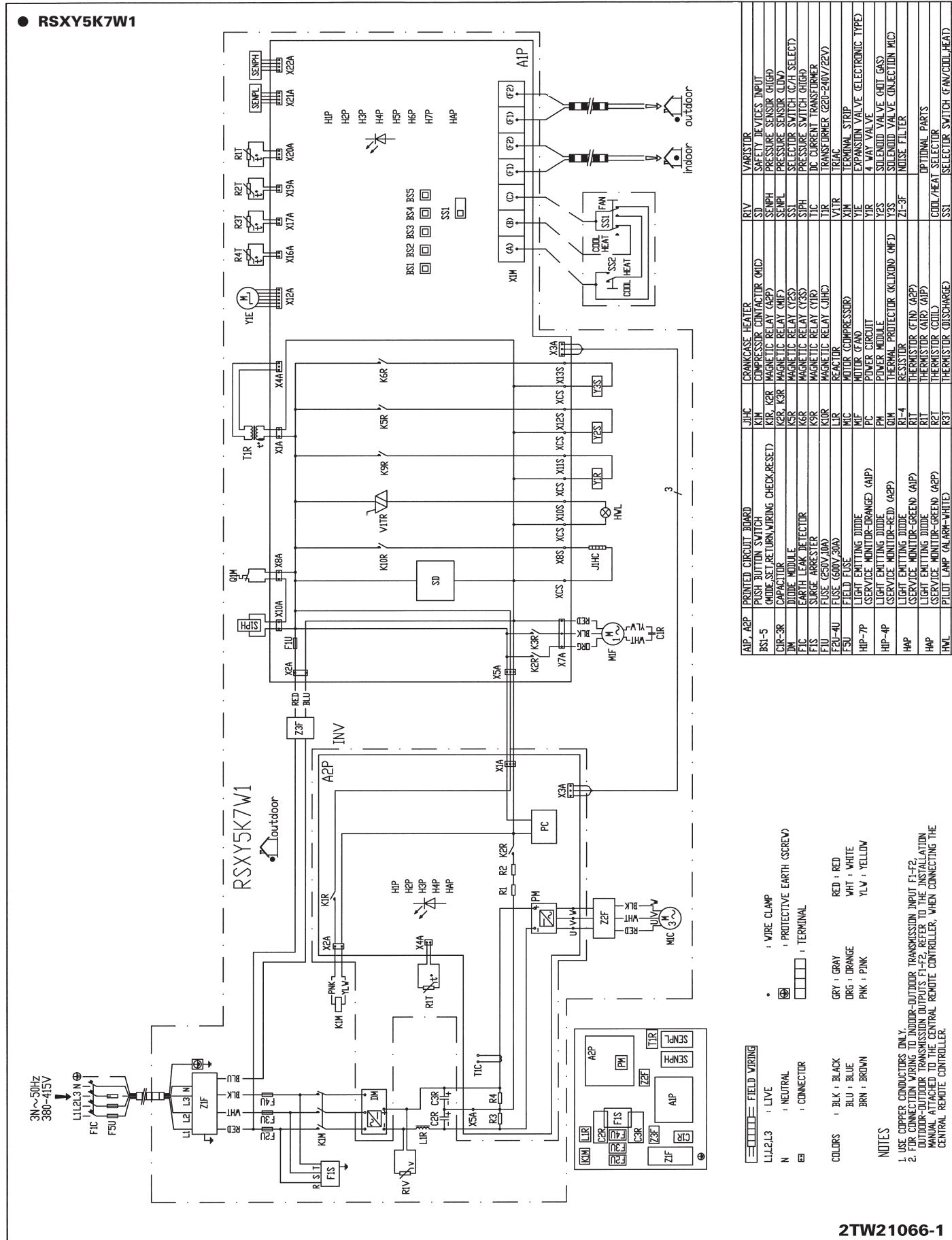



[50Hz 380~415V]

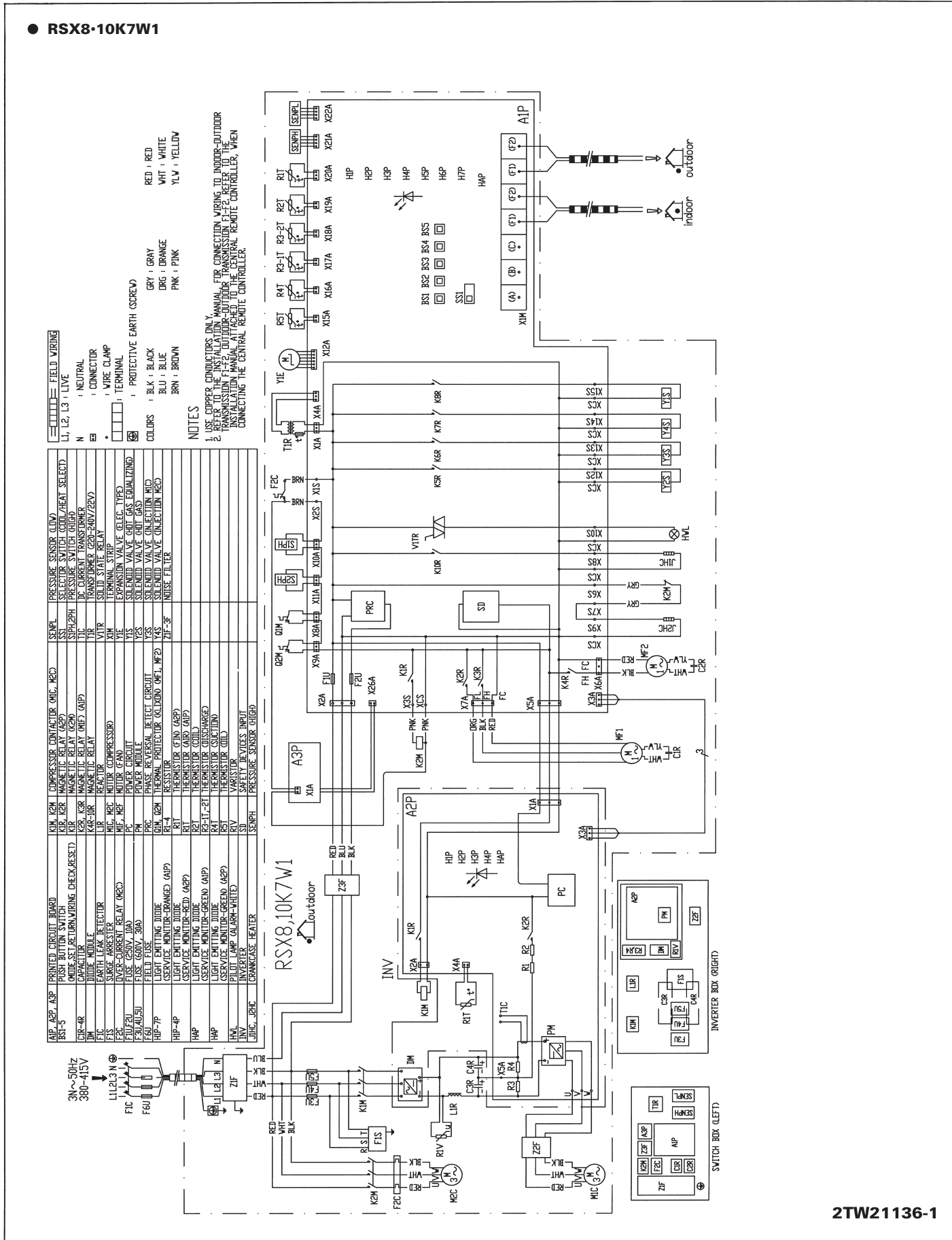

2TW21136-1

Все каталоги и инструкции здесь: <https://splitsystema48.ru/instrukcii-po-ekspluatatsii-kondicionerov.html>





■ Ceiling mounted cassette type (Multi-flow)

• FXYC20K/25K/32K/63K7V1

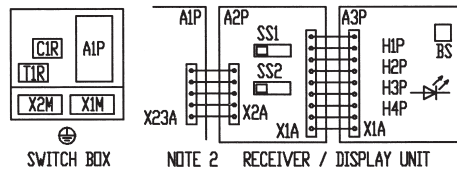
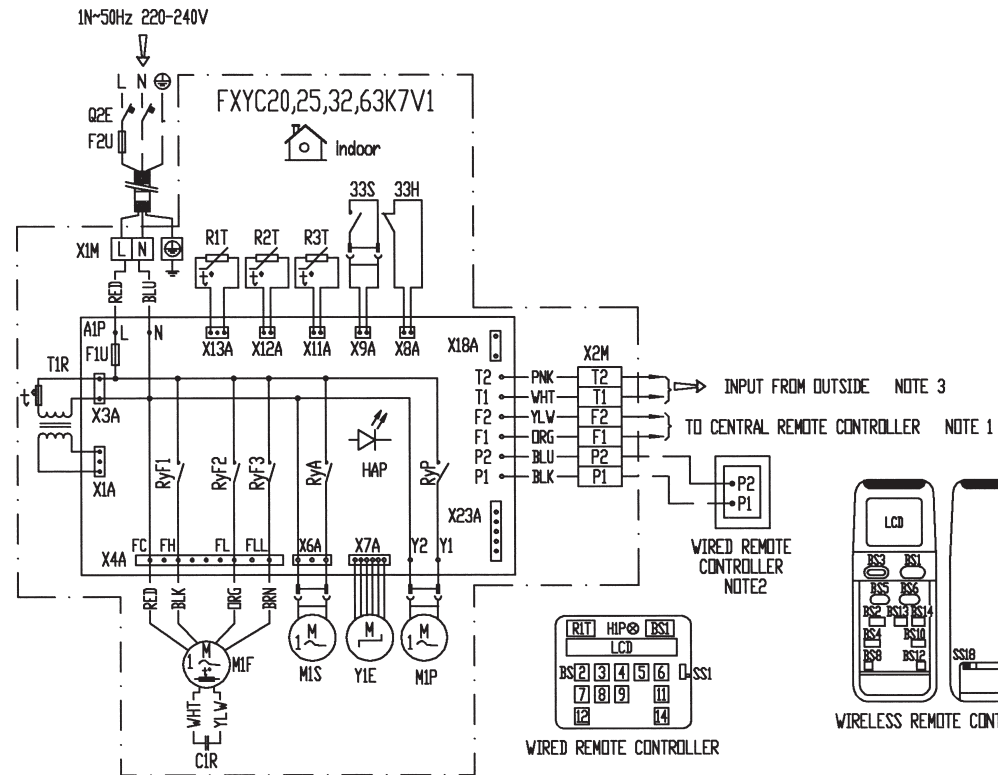

FIELD WIRING

- L : LIVE
N : NEUTRAL
CIR → : CONNECTOR
• : WIRE CLAMP
⊕ : PROTECTIVE EARTH (SCREW)
- COLORS :
BLK : BLACK
BLU : BLUE
BRN : BROWN
DRG : ORANGE
- PNK : PINK
RED : RED
WHT : WHITE
YLW : YELLOW

NOTES :

1. WHEN USING A CENTRAL REMOTE CONTROLLER, SEE MANUAL FOR CONNECTION TO THE UNIT.
2. X23A IS CONNECTED WHEN THE WIRELESS REMOTE CONTROLLER KIT IS USED.
3. WHEN CONNECTING THE INPUT WIRES FROM THE OUTDOOR UNIT, "FORCED OFF" OR "ON/OFF" OPERATION CAN BE SELECTED BY THE REMOTE CONTROLLER. FOR MORE DETAILS SEE INSTALLATION MANUAL.
4. USE COPPER CONDUCTORS ONLY.

2TW21386-1

33H	FLOAT SWITCH	SS1	SELECTOR SWITCH (MAIN/SUB)
33S	LIMIT SWITCH (SWING FLAP)		WIRELESS REMOTE CONTROLLER
AIP	PRINTED CIRCUIT BOARD	BS1	ON/OFF BUTTON
CIR	CAPACITOR (MIF)	BS2	TIMER MODE START/STOP BUTTON
FLT	THERMAL FUSE (152°C) (MIF EMBEDDED)	BS3	FAN SPEED CONTROL BUTTON
F1U	FUSE (250V, 5A)	BS4	ADJUSTEMENT OF AIR FLOW DIRECTION
F2U	FIELD FUSE	BS5, BS6	TIME/TEMPERATURE SET BUTTON
HAP	LIGHT EMITTING DIODE (SERVICE MONITOR-GREEN)	BS8	INSPECTION/TEST OPERATION BUTTON
MIF	MOTOR (INDOOR FAN)	BS10	OPERATION MODE SELECTOR BUTTON
MIS	MOTOR (SWING FLAP)	BS12	FILTER SIGN RESET BUTTON
MIP	MOTOR (DRAIN PUMP)	BS13	TIMER ON BUTTON
R1T	THERMISTOR (AIR)	BS14	TIMER OFF BUTTON
R2T, R3T	THERMISTOR (COIL)	LCD	LIQUID CRYSTAL DISPLAY
Q2E	EARTH LEAK DETECTOR	SS18	SELECTOR SWITCH (WIRELESS ADDRESS SET)
RvA	MAGNETIC RELAY (ONS)		RECEIVER/DISPLAY UNIT (ATTACHED TO WIRELESS REMOTE CONTROLLER)
RvF1-3	MAGNETIC RELAY (MIF)	A2P, A3P	PRINTED CIRCUIT BOARD
RyP	MAGNETIC RELAY (MIF)	BS	ON/OFF BUTTON
T1R	TRANSFORMER (220-240V/22V)	H1P	LIGHT EMITTING DIODE (ON-RED)
X1M	TERMINAL STRIP (POWER)	H2P	LIGHT EMITTING DIODE (TIMER-GREEN)
X2M	TERMINAL STRIP (CONTROL)	H3P	LIGHT EMITTING DIODE (FILTER SIGN-RED)
Y1E	ELECTRONIC EXPANSION VALVE	H4P	LIGHT EMITTING DIODE (DEFROST-ORANGE)
	WIRELESS REMOTE CONTROLLER	SS1	SELECTOR SWITCH (MAIN/SUB)
BS1	ON/OFF BUTTON	SS2	SELECTOR SWITCH (WIRELESS ADDRESS SET)
BS2	TIMER MODE START/STOP BUTTON		CONNECTOR FOR OPTIONAL PARTS
BS3, BS8	PROGRAMMING TIME BUTTON	X18A	CONNECTOR (WIRING, ADAPTOR FOR ELECTRICAL APPENDICES)
BS4, BS9	TEMPERATURE SETTING BUTTON	X23A	CONNECTOR (WIRELESS REMOTE CONTROLLER)
BS5	ADJUSTEMENT OF AIR FLOW DIRECTION		
BS6	OPERATION MODE SELECTOR BUTTON		
BS7	TIMER ON/OFF BUTTON		
BS11	FAN SPEED CONTROL BUTTON		
BS12	INSPECTION/TEST OPERATION BUTTON		
BS14	FILTER SIGN RESET BUTTON		
H1P	LIGHT EMITTING DIODE (ON-RED)		
LCD	LIQUID CRYSTAL DISPLAY		
R1T	THERMISTOR (AIR)		

Все каталоги и инструкции здесь: <https://splitssystema48.ru/instrukcii-po-ekspluatatsii-kondicionerov.html>





• FXYC40K/50K/80K/125K7V1

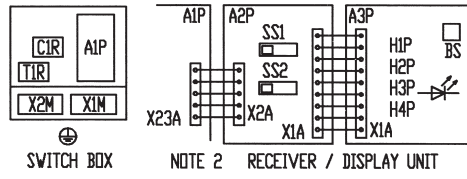
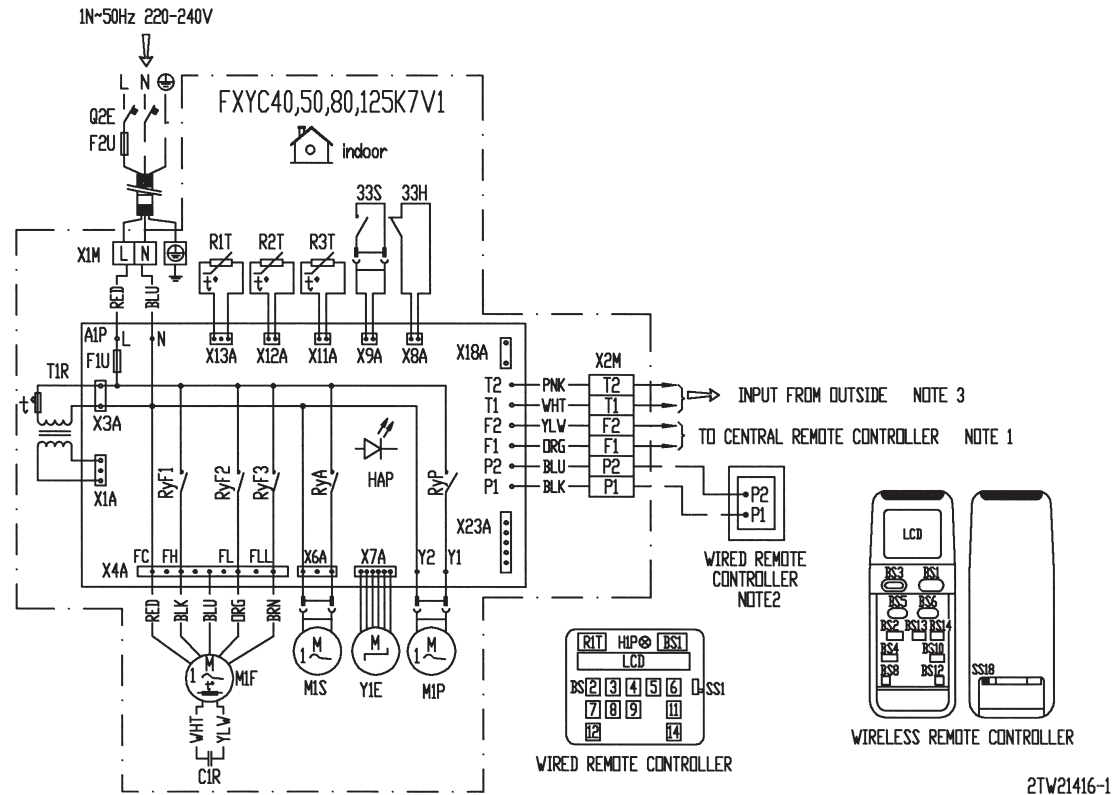

FIELD WIRING		COLORS :	
L	: LIVE	BLK	: BLACK
N	: NEUTRAL	BLU	: BLUE
⊠	: CONNECTOR	BRN	: BROWN
⊙	: WIRE CLAMP	DRG	: DRANGE
⊕	: PROTECTIVE EARTH (SCREW)	PNK	: PINK
		RED	: RED
		WHT	: WHITE
		YLW	: YELLOW

- NOTES :
1. WHEN USING A CENTRAL REMOTE CONTROLLER, SEE MANUAL FOR CONNECTION TO THE UNIT.
 2. X23A IS CONNECTED WHEN THE WIRELESS REMOTE CONTROLLER KIT IS USED.
 3. WHEN CONNECTING THE INPUT WIRES FROM THE OUTDOOR UNIT, "FORCED OFF" OR "ON/OFF" OPERATION CAN BE SELECTED BY THE REMOTE CONTROLLER. FOR MORE DETAILS SEE INSTALLATION MANUAL.
 4. USE COPPER CONDUCTORS ONLY.

2TW21416-1

33H	FLOAT SWITCH	SS1	SELECTOR SWITCH (MAIN/SUB)
33S	LIMIT SWITCH (SWING FLAP)		WIRELESS REMOTE CONTROLLER
AIP	PRINTED CIRCUIT BOARD	BS1	ON/OFF BUTTON
CIR	CAPACITOR (MIF)	BS2	TIMER MODE START/STOP BUTTON
FLT	THERMAL FUSE (152°C) (MIF EMBEDDED)	BS3	FAN SPEED CONTROL BUTTON
FIU	FUSE (250V, 5A)	BS4	ADJUSTEMENT OF AIR FLOW DIRECTION
F2U	FIELD FUSE	BS5, BS6	TIME/TEMPERATURE SET BUTTON
HAP	LIGHT EMITTING DIODE (SERVICE MONITOR-GREEN)	BS8	INSPECTION/TEST OPERATION BUTTON
MIF	MOTOR (INDOOR FAN)	BS10	OPERATION MODE SELECTOR BUTTON
MIS	MOTOR (SWING FLAP)	BS12	FILTER SIGN RESET BUTTON
MIP	MOTOR (DRAIN PUMP)	BS13	TIMER ON BUTTON
R1T	THERMISTOR (AIR)	BS14	TIMER OFF BUTTON
R2T, R3T	THERMISTOR (COIL)	LCD	LIQUID CRYSTAL DISPLAY
Q2E	EARTH LEAK DETECTOR	SS18	SELECTOR SWITCH (WIRELESS ADDRESS SET)
RyA	MAGNETIC RELAY (MIS)		RECEIVER/DISPLAY UNIT (ATTACHED TO WIRELESS REMOTE CONTROLLER)
RyF1-3	MAGNETIC RELAY (MIF)	A2P, A3P	PRINTED CIRCUIT BOARD
RyP	MAGNETIC RELAY (MIP)	BS	ON/OFF BUTTON
TIR	TRANSFORMER (220-240V/22V)	HIP	LIGHT EMITTING DIODE (ON-RED)
X1M	TERMINAL STRIP (POWER)	H2P	LIGHT EMITTING DIODE (TIMER-GREEN)
X2M	TERMINAL STRIP (CONTROL)	H3P	LIGHT EMITTING DIODE (FILTER SIGN-RED)
Y1E	ELECTRONIC EXPANSION VALVE	H4P	LIGHT EMITTING DIODE (DEFROST-ORANGE)
	WIRELESS REMOTE CONTROLLER	SS1	SELECTOR SWITCH (MAIN/SUB)
BS1	ON/OFF BUTTON	SS2	SELECTOR SWITCH (WIRELESS ADDRESS SET)
BS2	TIMER MODE START/STOP BUTTON		CONNECTOR FOR OPTIONAL PARTS
BS3, BS8	PROGRAMMING TIME BUTTON	X18A	CONNECTOR (WIRING, ADAPTOR FOR ELECTRICAL APPENDICES)
BS4, BS9	TEMPERATURE SETTING BUTTON	X23A	CONNECTOR (WIRELESS REMOTE CONTROLLER)
BS5	ADJUSTEMENT OF AIR FLOW DIRECTION		
BS6	OPERATION MODE SELECTOR BUTTON		
BS7	TIMER ON/OFF BUTTON		
BS11	FAN SPEED CONTROL BUTTON		
BS12	INSPECTION/TEST OPERATION BUTTON		
BS14	FILTER SIGN RESET BUTTON		
HIP	LIGHT EMITTING DIODE (ON-RED)		
LCD	LIQUID CRYSTAL DISPLAY		
R1T	THERMISTOR (AIR)		

2TW21416-1

Все каталоги и инструкции здесь: <https://splitssystema48.ru/instrukcii-po-ekspluatatsii-kondicionerov.html>



■ Ceiling mounted cassette type (Multi-flow)

● FXYP 20K / 25K / 32K / 40K / 50K / 63K / 80K / 100K / 125K

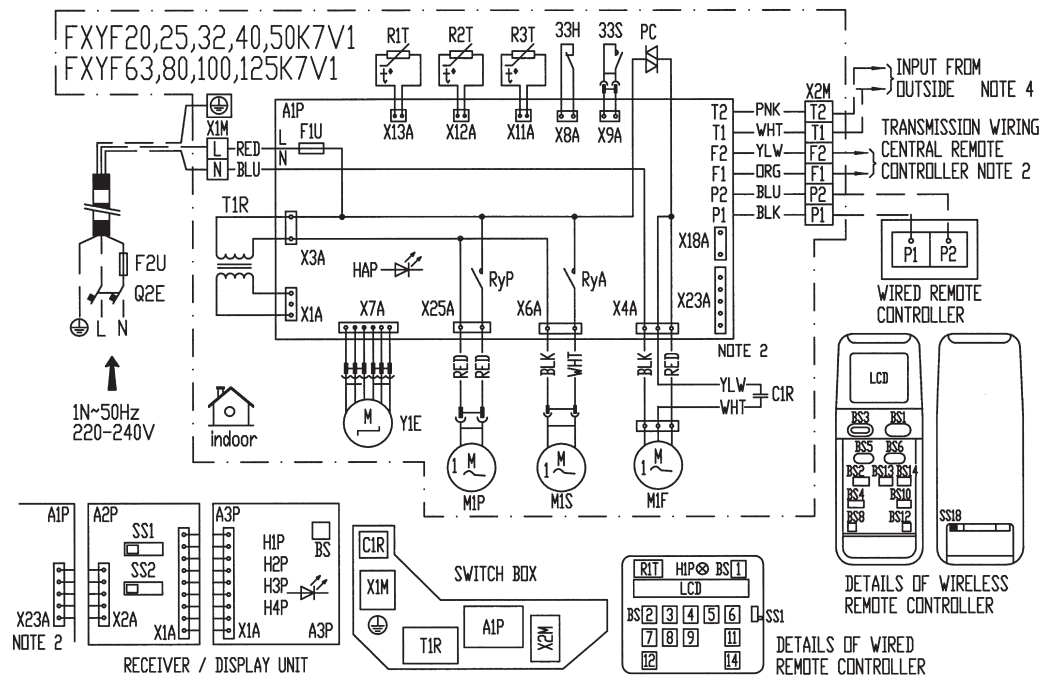

33H	FLOAT SWITCH	BS2	TIMER MODE START/STOP BUTTON	LCD	LIQUID CRYSTAL DISPLAY
33S	LIMIT SWITCH (SWING FLAP)	BS3, BS8	PROGRAMMING TIME BUTTON	SS1B	SELECTOR SWITCH (WIRELESS ADDRESS SET)
AIP	PRINTED CIRCUIT BOARD	BS4, BS9	TEMPERATURE SETTING BUTTON	RECEIVER/DISPLAY UNIT (ATTACHED TO WIRELESS REMOTE CONTROLLER)	
CIR	CAPACITOR (MIF)	BS5	AIR FLOW DIRECTION ADJUST BUTTON		
F1U	FUSE (250V, 5A)	BS6	OPERATION MODE SELECTOR BUTTON		
F2U	FIELD FUSE	BS7	TIMER ON/OFF BUTTON	A2P, A3P	PRINTED CIRCUIT BOARD
HAP	LIGHT EMITTING DIODE (SERVICE MONITOR-GREEN)	BS11	FAN SPEED BUTTON	BS	ON/OFF BUTTON
MIF	MOTOR (INDOOR FAN)	BS12	INSPECTION/TEST BUTTON	HIP	LIGHT EMITTING DIODE (ON-RED)
MIP	MOTOR (DRAIN PUMP)	BS14	FILTER SIGN RESET BUTTON	H2P	LIGHT EMITTING DIODE (TIMER-GREEN)
MIS	MOTOR (SWING FLAP)	HIP	LIGHT EMITTING DIODE (SERVICE MONITOR-RED)	H3P	LIGHT EMITTING DIODE (FILTER SIGN-RED)
QIF	THERMIST SWITCH (MIF EMBEDDED)	LCD	LIQUID CRYSTAL DISPLAY	H4P	LIGHT EMITTING DIODE (DEFROST-ORANGE)
Q2E	EARTH LEAK DETECTOR	SS1	SELECTOR SWITCH (MAIN/SUB)	SS1	SELECTOR SWITCH (MAIN/SUB)
R1T	THERMISTOR (AIR)	WIRELESS REMOTE CONTROLLER			
R2T, R3T	THERMISTOR (COIL)	BS1	ON/OFF BUTTON	SS2	SELECTOR SWITCH (WIRELESS ADDRESS SET)
RyA	MAGNETIC RELAY (MIS)	BS2	TIMER MODE START/STOP BUTTON		
RyP	MAGNETIC RELAY (MIP)	BS3	PUSH BUTTON (FAN SPEED)		
T1R	TRANSFORMER (220V-240V/27V)	BS4	AIR FLOW DIRECTION ADJUST BUTTON		
X1M	TERMINAL STRIP (POWER)	BS5, BS6	TIME/TEMPERATURE SET BUTTON	CONNECTOR FOR OPTIONAL PARTS	
X2M	TERMINAL STRIP (CONTROL)	BS8	INSPECTION/TEST BUTTON	X18A	CONNECTOR (WIRING ADAPTOR FOR ELECTRICAL APPENDICES)
PC	PHASE CONTROL CIRCUIT	BS10	OPERATION MODE SELECTOR BUTTON	X23A	CONNECTOR (WIRELESS REMOTE CONTROLLER)
Y1E	ELECTRONIC EXPANSION VALVE	BS12	FILTER SIGN RESET BUTTON		
WIRED REMOTE CONTROLLER		BS13	TIMER ON BUTTON		
BS1	ON/OFF BUTTON	BS14	TIMER OFF BUTTON		

	FIELD WIRING		WIRE CLAMP	COLORS :	BLU : BLUE	PNK : PINK
	CONNECTOR		PROTECTIVE EARTH (SCREW)		BLK : BLACK	RED : RED
	TERMINAL				GRN : GREEN	WHT : WHITE
					DRG : ORANGE	YLW : YELLOW

- NOTES
1. USE COPPER CONDUCTORS ONLY.
 2. WHEN USING THE CENTRAL REMOTE CONTROLLER, SEE MANUAL FOR CONNECTION TO THE UNIT.
 3. X23A IS CONNECTED WHEN THE WIRELESS REMOTE CONTROLLER KIT IS USED.
 4. WHEN CONNECTING THE INPUT WIRES FROM OUTSIDE, FORCED OFF OR ON/OFF CONTROL OPERATION CAN BE SELECTED BY THE REMOTE CONTROLLER MANUAL. SEE INSTALLATION MANUAL FOR MORE DETAILS.

2TW 21266-1

Все каталоги и инструкции здесь: <https://splitssystema48.ru/instrukcii-po-ekspluatatsii-kondicionerov.html>



■ Ceiling mounted cassette corner type

● FXYK25K/32K/40K/63KV1

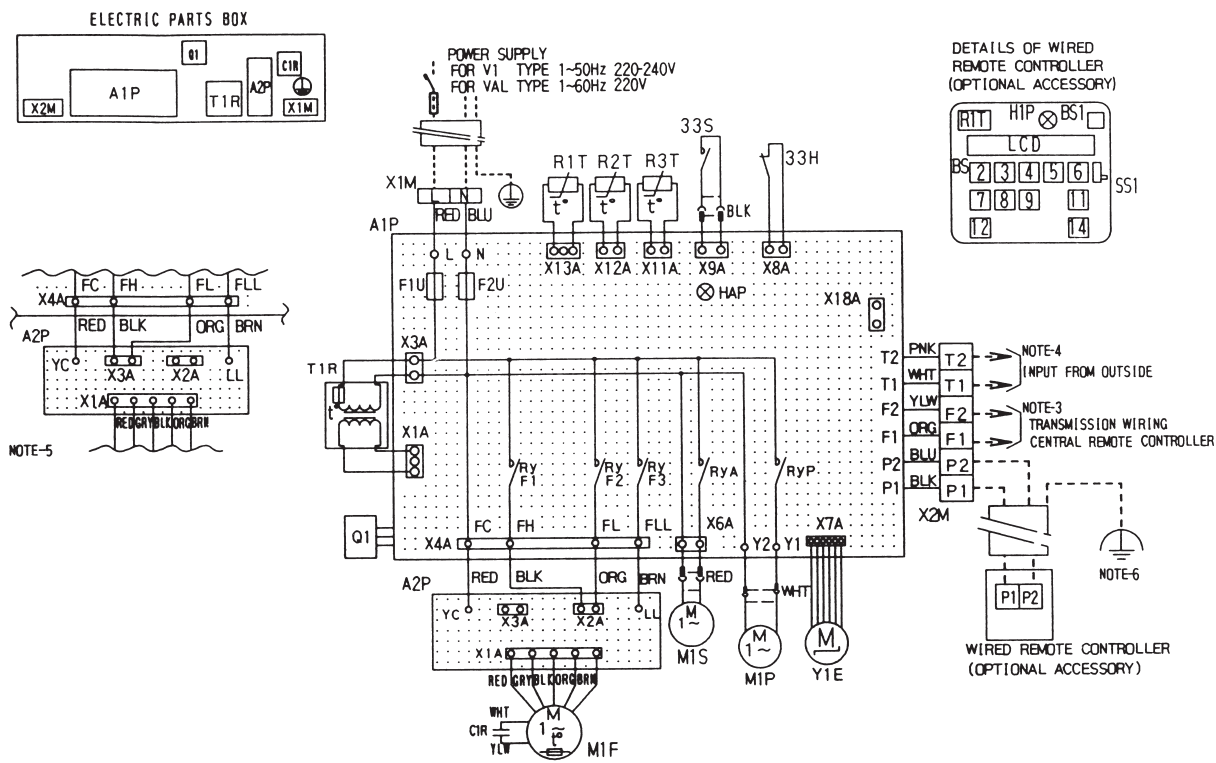

- NOTES)
1. : TERMINAL, : CONNECTOR, : WIRE CLAMP
 2. - - - - : FIELD WIRING
 3. IN CASE USING CENTRAL REMOTE CONTROLLER, CONNECT IT TO THE UNIT IN ACCORDANCE WITH THE ATTACHED INSTRUCTION MANUAL.
 4. WHEN CONNECTING THE INPUT WIRES FROM OUTSIDE, FORCED OFF OR ON/OFF CONTROL OPERATION CAN BE SELECTED BY REMOTE CONTROLLER. IN DETAILS, REFER TO THE INSTALLATION MANUAL ATTACHED THE UNIT.
 5. IN CASE HIGH E.S.P. OPERATION, CHANGE OVER THE WIRING CONNECTION FROM X2A TO X3A.
 6. SYMBOLS SHOW AS FOLLOWS, (PNK: PINK WHT: WHITE YLW: YELLOW ORG: ORANGE BLU: BLUE BLK: BLACK RED: RED BRN: BROWN GRY: GRAY)
 7. USE COPPER CONDUCTORS ONLY.

33H	FLOAT SWITCH	X2M	TERMINAL STRIP (CONTROL)
33S	LIMIT SWITCH (SWING FLAP)	Y1E	ELECTRONIC EXPANSION VALVE
A1P	PRINTED CIRCUIT BOARD		
A2P	TERMINAL BOARD		WIRED REMOTE CONTROLLER (BRC1A61)
C1R	CAPACITOR (M1F)	R1T	THERMISTOR (AIR)
F1T	THERMAL FUSE (105°C) (M1F EMBEDDED)	SS1	SELECTOR SWITCH (MAIN/SUB) CONNECTOR FOR OPTIONAL PARTS
F1U	FUSE (250V, 5A)	X18A	CONNECTOR/WIRING ADAPTOR FOR ELECTRICAL APPENDICES
HAP	LIGHT EMISSION DIODE (SERVICE MONITOR-GREEN)		
M1F	MOTOR (INDOOR FAN)		
M1P	MOTOR (DRAIN PUMP)		
M1S	MOTOR (SWING FLAP)		
R1T	THERMISTOR (AIR)		
R2T-3T	THERMISTOR (COIL)		
RYA	MAGNETIC RELAY (M1S)		
RYF1-3	MAGNETIC RELAY (M1F)		
RYP	MAGNETIC RELAY (M1P)		
T1R	TRANSFORMER (220-240V/220V)		
X1M	TERMINAL STRIP (POWER)		

DU227-544A

Все каталоги и инструкции здесь: <https://splitssystema48.ru/instrukcii-po-ekspluatatsii-kondicionerov.html>



■ Ceiling mounted cassette built-in type

• FXYS20K/25K/32K/40K/50K/63K7V1

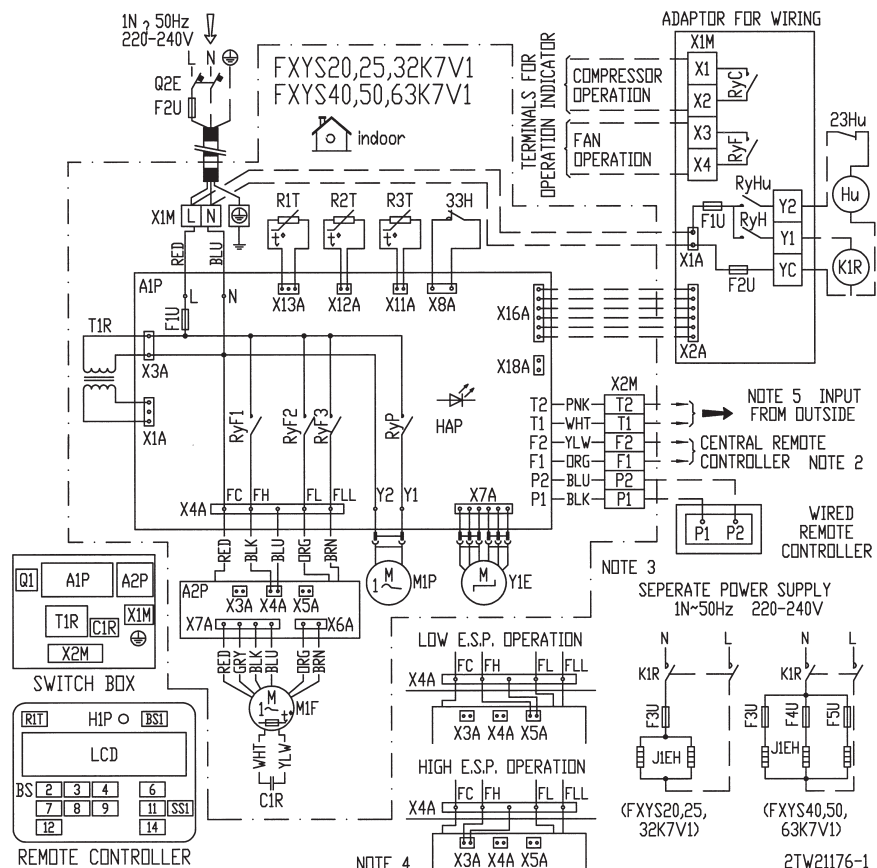

NOTES :

1. USE COPPER CONDUCTORS ONLY.
2. WHEN USING THE CENTRAL REMOTE CONTROLLER, SEE MANUAL FOR CONNECTION TO THE UNIT.
3. WHEN INSTALLING THE ELECTRIC HEATER, CHANGE THE WIRING FOR THE HEATER CIRCUIT. THE MAIN POWER SUPPLY HAS TO BE SUPPLIED INDEPENDENTLY.
4. FOR HIGH OR LOW E.S.P. OPERATION, CHANGE THE WIRING CONNECTION OF X4A AS SHOWN ON THE WIRING DIAGRAM.
5. WHEN CONNECTING THE INPUT WIRES FROM OUTSIDE, 'FORCED OFF' OR 'ON/OFF' OPERATION CAN BE SELECTED BY THE REMOTE CONTROLLER. SEE INSTALLATION MANUAL FOR MORE DETAILS.

FIELD WIRING

- L : LIVE
- N : NEUTRAL
- : CONNECTOR
- : WIRE CLAMP
- ⊕ : PROTECTIVE EARTH (SCREW)

- COLORS :
- BLK : BLACK
 - BLU : BLUE
 - BRN : BROWN
 - GRY : GREY
 - DRG : DRANGE
 - PNK : PINK
 - RED : RED
 - WHT : WHITE
 - YLW : YELLOW

2TW21176-1

33H	FLOAT SWITCH	K1R	MAGNETIC RELAY (JIEH)
A1P	PRINTED CIRCUIT BOARD		ADAPTOR FOR WIRING
A2P	TERMINAL BOARD	RvC, RvF	MAGNETIC RELAY
C1R	CAPACITOR (FAN)	RvH, RvHu	MAGNETIC RELAY (JIEH, Hu)
F1U	FUSE (250V, 10A)	F1U, F2U	FUSE (250V, 5A)
F2U	FIELD FUSE	X1A, X2A	CONNECTOR (WIRING ADAPTOR)
HAP	LIGHT EMITTING DIODE (SERVICE MONITOR-GREEN)	X1M	TERMINAL STRIP
M1F	MOTOR (FAN)		CONNECTOR FOR OPTIONAL PARTS
M1P	MOTOR (DRAIN PUMP)	X16A	CONNECTOR (WIRING ADAPTOR)
Q1	POWER TRANSISTOR	X18A	CONNECTOR (WIRING ADAPTOR FOR ELECTRONICAL APPENDICES)
Q2E	EARTH LEAK DETECTOR		WIRED REMOTE CONTROLLER
R1T, R3T	THERMISTOR (REFRIGERANT)	BS1	ON/OFF BUTTON
RvF1-3	MAGNETIC RELAY (FAN)	BS2	TIMER MODE START/STOP BUTTON
RvP	MAGNETIC RELAY (DRAIN PUMP)	BS3, BS8	PROGRAMMING TIME BUTTON
T1R	TRANSFORMER (220V/27V)	BS4, BS9	TEMPERATURE SETTING BUTTON
X1M	TERMINAL STRIP (POWER)	BS6	OPERATION MODE SELECTOR BUTTON
X2M	TERMINAL STRIP (CONTROL)	BS7	TIMER ON/OFF BUTTON
Y1E	ELECTRONIC EXPANSION VALVE	BS11	FAN SPEED CONTROL BUTTON
	OPTIONAL PARTS	BS12	INSPECTION/TEST OPERATION BUTTON
23Hu	HUMIDISTAT	BS14	FILTER SIGN RESET BUTTON
F3-5U	FUSE (250V, 16A)	LCD	LIQUID CRISTAL DISPLAY
Hu	HUMIDIFIER	H1P	LIGHT EMITTING DIODE (ON-RED)
JIEH	ELECTRIC HEATER	R1T	THERMISTOR (AIR)
		SS1	SELECTOR SWITCH (MAIN/SUB)

Все каталоги и инструкции здесь: <https://splitssystem48.ru/instrukcii-po-ekspluatatsii-kondicionerov.html>





■ Ceiling mounted cassette built-in type

● FXYS80K/100K/125KV1

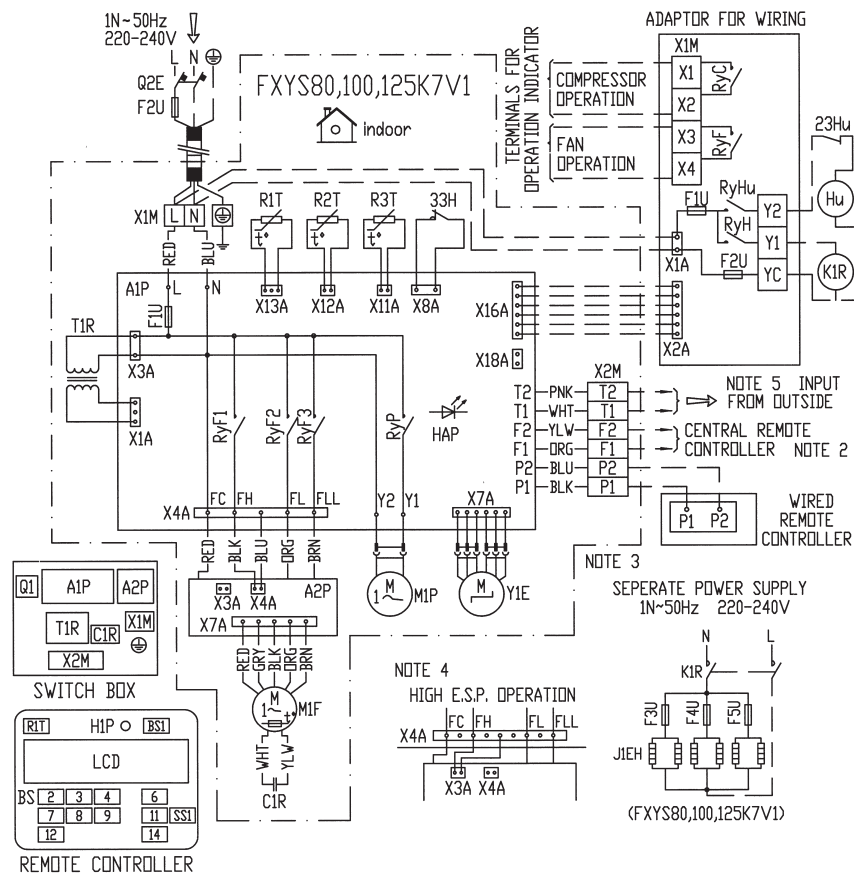

FIELD WIRING

L : LIVE
N : NEUTRAL
C : CONNECTOR
W : WIRE CLAMP
PE : PROTECTIVE EARTH (SCREW)

COLORS : BLK : BLACK
BLU : BLUE
BRN : BROWN
GRY : GREY
ORG : ORANGE
PNK : PINK
RED : RED
WHT : WHITE
YLW : YELLOW

NOTES :

1. USE COPPER CONDUCTORS ONLY.
2. WHEN USING THE CENTRAL REMOTE CONTROLLER, SEE MANUAL FOR CONNECTION TO THE UNIT.
3. WHEN INSTALLING THE ELECTRIC HEATER, CHANGE THE WIRING FOR THE HEATER CIRCUIT. THE MAIN POWER SUPPLY HAS TO BE SUPPLIED INDEPENDENTLY.
4. FOR HIGH E.S.P. OPERATION, CHANGE THE WIRING CONNECTION OF X4A AS SHOWN ON THE WIRING DIAGRAM.
5. WHEN CONNECTING THE INPUT WIRES FROM OUTSIDE, FORCED 'OFF' OR 'ON/OFF' OPERATION CAN BE SELECTED BY THE REMOTE CONTROLLER. SEE INSTALLATION MANUAL FOR MORE DETAILS.

33H	FLOAT SWITCH	K1R	MAGNETIC RELAY (J1EH)
A1P	PRINTED CIRCUIT BOARD	L	ADAPTOR FOR WIRING
A2P	TERMINAL BOARD	RyC, RyF	MAGNETIC RELAY
C1R	CAPACITOR (FAN)	RyH, RyHu	MAGNETIC RELAY
F1U	FUSE (250V, 10A)	F1U, F2U	FUSE (250V, 5A)
F2U	FIELD FUSE	X1A, X2A	CONNECTOR (WIRING ADAPTOR)
HAP	LIGHT EMITTING DIODE (SERVICE MONITOR-GREEN)	X1M	TERMINAL STRIP
M1F	MOTOR (FAN)	X16A	CONNECTOR FOR OPTIONAL PARTS
M1P	MOTOR (DRAIN PUMP)	X18A	CONNECTOR (WIRING ADAPTOR)
Q1	POWER TRANSISTOR	X18A	CONNECTOR (WIRING ADAPTOR FOR ELECTRONICAL APPENDICES)
Q2E	EARTH LEAK DETECTOR		WIRED REMOTE CONTROLLER
R1T	THERMISTOR (AIR)	BS1	ON/OFF BUTTON
R2T, R3T	THERMISTOR (REFRIGERANT)	BS2	TIMER MODE START/STOP BUTTON
RyF1-3	MAGNETIC RELAY (FAN)	BS3, BS8	PROGRAMMING TIME BUTTON
RyP	MAGNETIC RELAY (DRAIN PUMP)	BS4, BS9	TEMPERATURE SETTING BUTTON
T1R	TRANSFORMER (220V/27V)	BS6	OPERATION MODE SELECTOR BUTTON
X1M	TERMINAL STRIP (POWER)	BS7	TIMER ON/OFF BUTTON
X2M	TERMINAL STRIP (CONTROL)	BS11	FAN SPEED CONTROL BUTTON
Y1E	ELECTRONIC EXPANSION VALVE	BS12	INSPECTION/TEST OPERATION BUTTON
	OPTIONAL PARTS	BS14	FILTER SIGN RESET BUTTON
23Hu	HUMIDISTAT	LCD	LIQUID CRISTAL DISPLAY
F3-5U	FUSE (250V, 16A)	H1P	LIGHT EMITTING DIODE (ON-RED)
Hu	HUMIDIFIER	R1T	THERMISTOR (AIR)
J1EH	ELECTRIC HEATER	SS1	SELECTOR SWITCH (MAIN/SUB)

2TW21236-1

Все каталоги и инструкции здесь: <https://splitssystema48.ru/instrukcii-po-ekspluatatsii-kondicionerov.html>





■ Ceiling mounted large duct type

● FXYM40K/50K/63K/80K/100K/125K

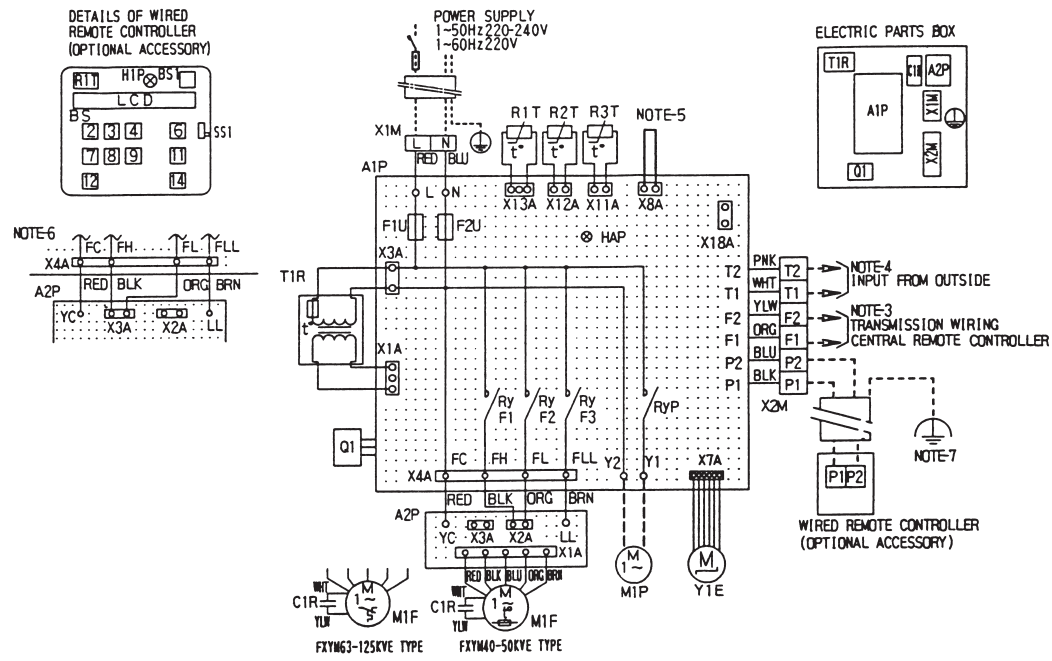

NOTES)

1. □ : TERMINAL, ⊠, ⊡ : CONNECTOR, ○ : WIRE CLAMP
⊞ : JUMPER CONNECTOR
2. - - - - : FIELD WIRING
3. IN CASE USING CENTRAL REMOTE CONTROLLER, CONNECT IT TO THE UNIT IN ACCORDANCE WITH THE ATTACHED INSTRUCTION MANUAL.
4. WHEN CONNECTING THE INPUT WIRES FROM OUTSIDE, FORCED OFF OR ON/OFF CONTROL OPERATION CAN BE SELECTED BY REMOTE CONTROLLER IN DETAILS, REFER TO THE INSTALLATION MANUAL ATTACHED THE UNIT.
5. IN CASE INSTALLING THE DRAIN PUMP, REMOVE THE JUMPER AND EXECUTE THE ADDITIONAL WIRING FOR FLOAT SWITCH(33H).
6. IN CASE HIGH E.S.P. OPERATION, CHANGE THE WIRING CONNECTION OF X2A AS SHOWN UPPER FIGURE.
7. SYMBOLS SHOW AS FOLLOWS.(PNK:PINK WHT:WHITE YLW:YELLOW ORG:ORANGE BLU:BLUE BLK:BLACK RED:RED BRN:BROWN)
8. USE COPPER CONDUCTORS ONLY.

A1P	PRINTED CIRCUIT BOARD	X1M	TERMINAL STRIP(POWER)
A2P	TERMINAL BOARD	X2M	TERMINAL STRIP(CONTROL)
CIR	CAPACITOR (M1F)	Y1E	ELECTRONIC EXPANSION VALVE
F1T	THERMAL FUSE(153°C) (M1F EMBEDDED ONLY 40-50 TYPE)		OPTIONAL PARTS
F1U-ZU	FUSE (250V, 10A)	M1P	MOTOR (DRAIN PUMP)
HAP	LIGHT EMISSION DIODE (SERVICE MONITOR-GREEN)		WIRED REMOTE CONTROLLER (BR1A6Z)
M1F	MOTOR (INDOOR FAN)	SS1	SELECTOR SWITCH (MAIN/SUB)
Q1	POWER TRANSISTOR		CONNECTOR FOR OPTIONAL PARTS
Q1F	THERMO SWITCH(M1F EMBEDDED ONLY 63-125 TYPE)	X8A	CONNECTOR(FLOAT SWITCH)
R1T	THERMISTOR(AIR)	X18A	CONNECTOR(WIRING ADAPTOR FOR ELECTRICAL APPENDICES)
R2T-3T	THERMISTOR(COIL)		
RYF1-3	MAGNETIC RELAY(M1F)		
RYP	MAGNETIC RELAY(M1P)		
T1R	TRANSFORMER(220-240V/27V)		

DU229-5140A

Все каталоги и инструкции здесь: <https://splitssystema48.ru/instrukcii-po-ekspluatatsii-kondicionerov.html>



■ Ceiling suspended type

● FXYH32K/63K/100K7V1

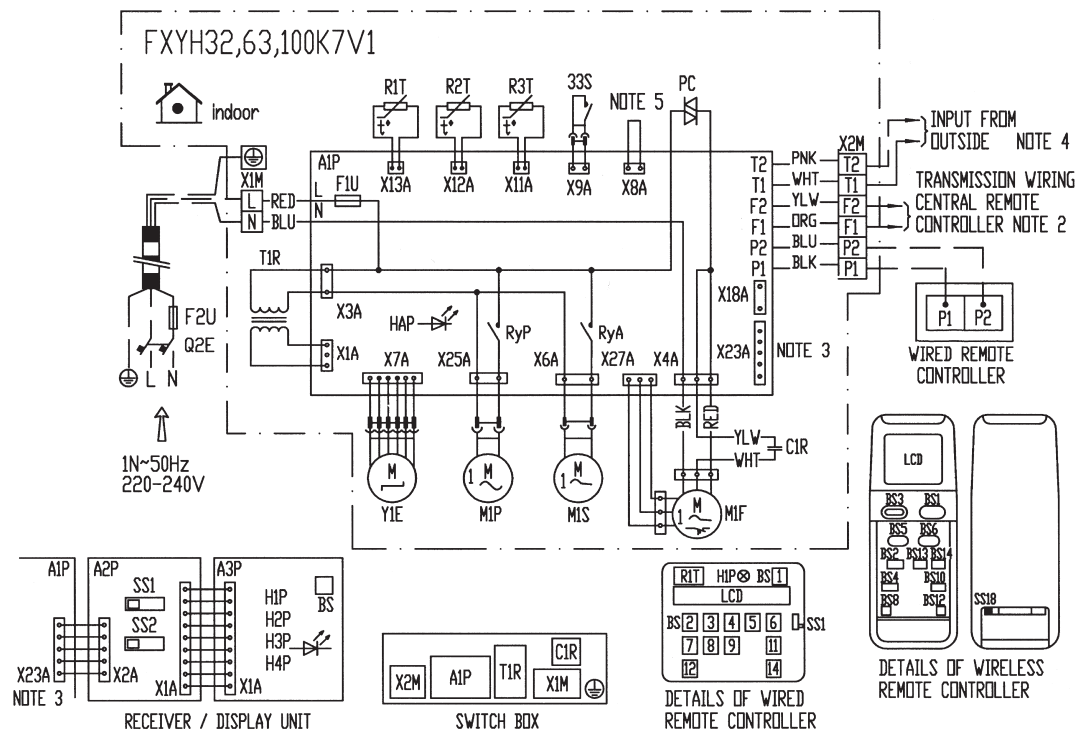

NOTES

1. USE COPPER CONDUCTORS ONLY.
2. WHEN USING THE CENTRAL REMOTE CONTROLLER, SEE MANUAL FOR CONNECTION TO THE UNIT.
3. X23A IS CONNECTED WHEN THE WIRELESS REMOTE CONTROLLER KIT IS USED.
4. WHEN CONNECTING THE INPUT WIRES FROM OUTSIDE, "FORCED OFF" OR "ON/OFF" CONTROL OPERATION CAN BE SELECTED BY THE REMOTE CONTROLLER MANUAL. SEE INSTALLATION MANUAL FOR MORE DETAILS.
5. WHEN INSTALLING THE DRAIN PUMP, REMOVE THE JUMPER OF CONNECTOR X8A AND EXECUTE THE ADDITIONAL WIRING FOR THE FLOAT SWITCH AND DRAIN PUMP.

33S	LIMIT SWITCH (SWING FLAP)	BS2	TIMER MODE START/STOP BUTTON	LCD	LIQUID CRYSTAL DISPLAY
AIP	PRINTED CIRCUIT BOARD	BS3, BS8	PROGRAMMING TIME BUTTON	SS18	SELECTOR SWITCH (WIRELESS ADDRESS SET)
C1R	CAPACITOR (MIF)	BS4, BS9	TEMPERATURE SETTING BUTTON		
F1U	FUSE (250V, 5A)	BS5	AIR FLOW DIRECTION ADJUST BUTTON		RECEIVER/DISPLAY UNIT (ATTACHED TO WIRELESS REMOTE CONTROLLER)
F2U	FIELD FUSE	BS6	OPERATION MODE SELECTOR BUTTON	A2P, A3P	PRINTED CIRCUIT BOARD
HAP	LIGHT EMITTING DIODE (SERVICE MONITOR-GREEN)	BS7	TIMER ON/OFF BUTTON	BS	ON/OFF BUTTON
MIF	MOTOR (INDOOR FAN)	BS11	FAN SPEED BUTTON	H1P	LIGHT EMITTING DIODE (ON-RED)
MIS	MOTOR (SWING FLAP)	BS12	INSPECTION/TEST BUTTON	H2P	LIGHT EMITTING DIODE (TIMER-GREEN)
PC	PHASE CONTROL CIRCUIT	BS14	FILTER SIGN RESET BUTTON	H3P	LIGHT EMITTING DIODE (FILTER SIGN-RED)
Q1F	THERMOSWITCH (MIF EMBEDDED)	H1P	LIGHT EMITTING DIODE (SERVICE MONITOR-RED)	H4P	LIGHT EMITTING DIODE (DEFROST-DRANGE)
Q2E	EARTH LEAK DETECTOR	LCD	LIQUID CRYSTAL DISPLAY	SS1	SELECTOR SWITCH (MAIN/SUB)
R1T	THERMISTOR (AIR)	SS1	SELECTOR SWITCH (MAIN/SUB)		
R2T, R3T	THERMISTOR (COIL)		WIRELESS REMOTE CONTROLLER		
RvA	MAGNETIC RELAY (MIS)	BS1	ON/OFF BUTTON		
RvP	MAGNETIC RELAY (MIP)	BS2	TIMER MODE START/STOP BUTTON		
T1R	TRANSFORMER (220V-240V/27V)	BS3	PUSH BUTTON (FAN SPEED)		
X1M	TERMINAL STRIP (POWER)	BS4	AIR FLOW DIRECTION ADJUST BUTTON		
X2M	TERMINAL STRIP (CONTROL)	BS5, BS6	TIME/TEMPERATURE SET BUTTON		CONNECTOR FOR OPTIONAL PARTS
Y1E	ELECTRONIC EXPANSION VALVE	BS8	INSPECTION/TEST BUTTON		
	OPTIONAL PARTS	BS10	OPERATION MODE SELECTOR BUTTON		
MIP	MOTOR (DRAIN PUMP)	BS12	FILTER SIGN RESET BUTTON		
	WIRELESS REMOTE CONTROLLER	BS13	TIMER ON BUTTON		
BS1	ON/OFF BUTTON	BS14	TIMER OFF BUTTON		
				X8A	CONNECTOR (FLOAT SWITCH)
				X18A	CONNECTOR (WIRING ADAPTOR FOR ELECTRICAL APPENDICES)
				X23A	CONNECTOR (WIRELESS REMOTE CONTROLLER)

2TW21356-1

Все каталоги и инструкции здесь: <https://splitssystema48.ru/instrukcii-po-ekspluatatsii-kondicionerov.html>



■ Wall mounted type

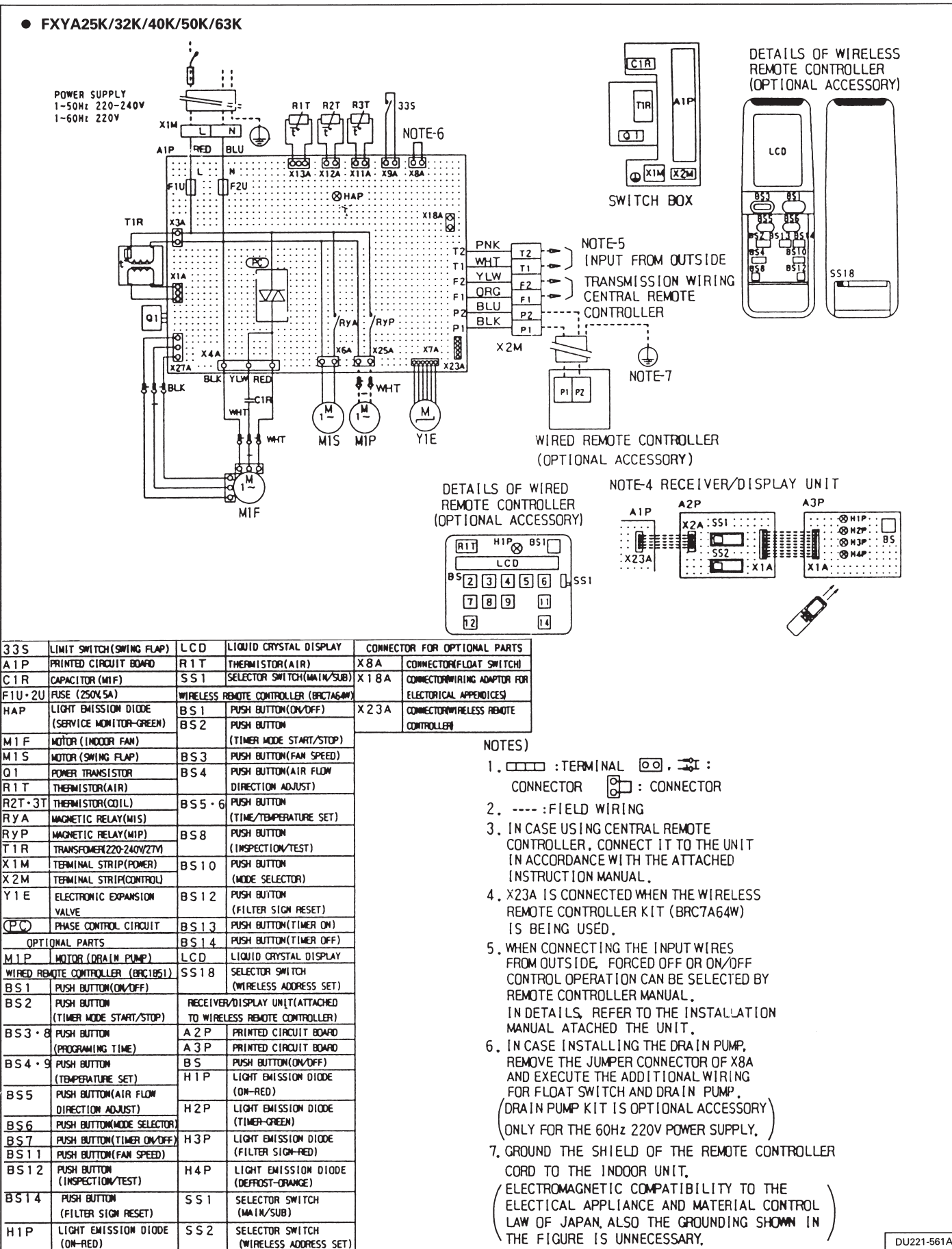

Все каталоги и инструкции здесь: <https://splitssystema48.ru/instrukcii-po-ekspluatatsii-kondicionerov.html>



■ Floor standing type / Concealed floor standing type

● FXYL (M) 20-25-32-40-50-63K

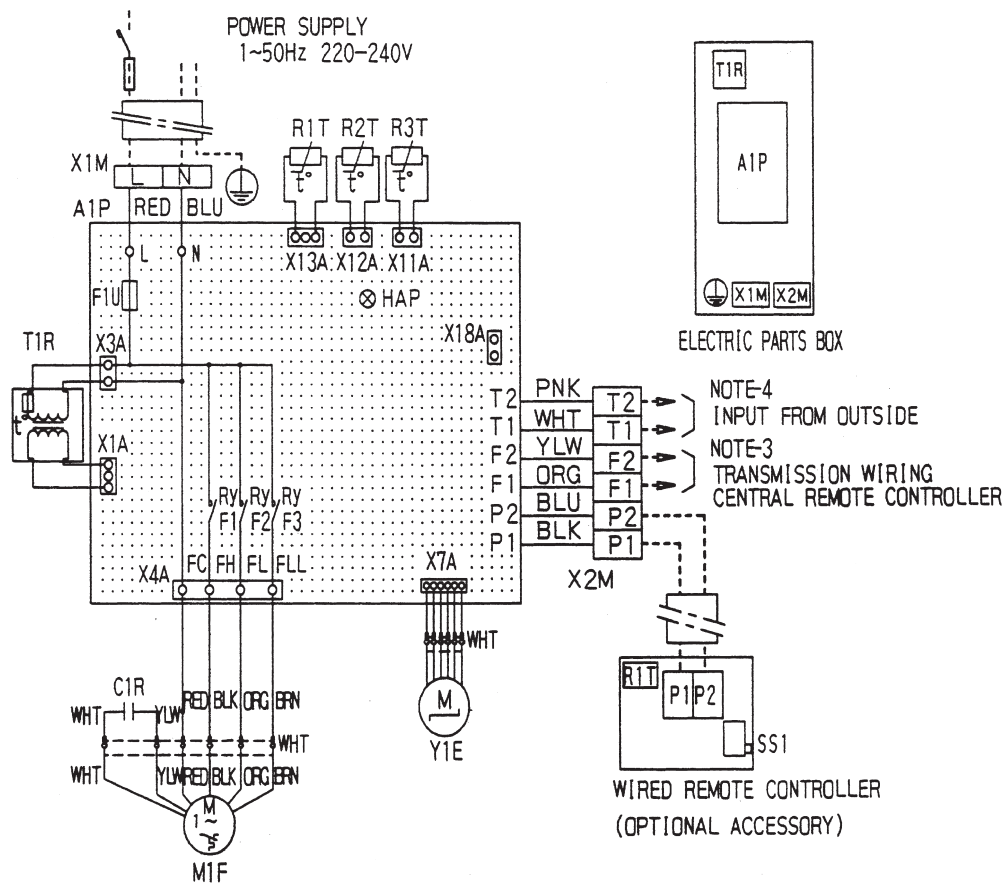

NOTES)

1. □: TERMINAL, ⊕: CONNECTOR, ○: WIRE CLAMP
2. ---: FIELD WIRING
3. IN CASE USING CENTRAL REMOTE CONTROLLER, CONNECT IT TO THE UNIT IN ACCORDANCE WITH THE ATTACHED INSTRUCTION MANUAL.
4. WHEN CONNECTING THE INPUT WIRES FROM OUTSIDE, FORCED OFF OR ON/OFF CONTROL OPERATION CAN BE SELECTED BY REMOTE CONTROLLER IN DETAILS, REFER TO THE INSTALLATION MANUAL ATTACHED THE UNIT.
5. SYMBOLS SHOW AS FOLLOWS.(PNK:PINK WHT:WHITE YLW:YELLOW ORG:ORANGE
BLU:BLUE BLK:BLACK RED:RED BRN:BROWN)
6. USE COPPER CONDUCTORS ONLY.

A1P	PRINTED CIRCUIT BOARD	WIRED REMOTE CONTROLLER	
C1R	CAPACITOR (M1F)	R1T	THERMISTOR (AIR)
F1U	FUSE (250V, 5A)	SS1	SELECTOR SWITCH (MAIN/SUB)
HAP	LIGHT EMISSION DIODE (SERVICE MONITOR-GREEN)	X18A	CONNECTOR (WIRING ADAPTOR FOR ELECTRICAL APPENDICES)
M1F	MOTOR (INDOOR FAN)		
Q1F	THERMO SWITCH (M1F EMBEDDED)		
R1T	THERMISTOR (AIR)		
R2T-3T	THERMISTOR (COIL)		
RYF1-3	MAGNETIC RELAY (M1F)		
T1R	TRANSFORMER (220-240V/22V)		
X1M	TERMINAL STRIP (POWER)		
X2M	TERMINAL STRIP (CONTROL)		
Y1E	ELECTRONIC EXPANSION VALVE		
L-RED	N-BLUE		

3D003923

Все каталоги и инструкции здесь: <https://splitssystem48.ru/instrukcii-po-ekspluatatsii-kondicionerov.html>



■ Ceiling mounted small duct type

● FXYB20/25K7

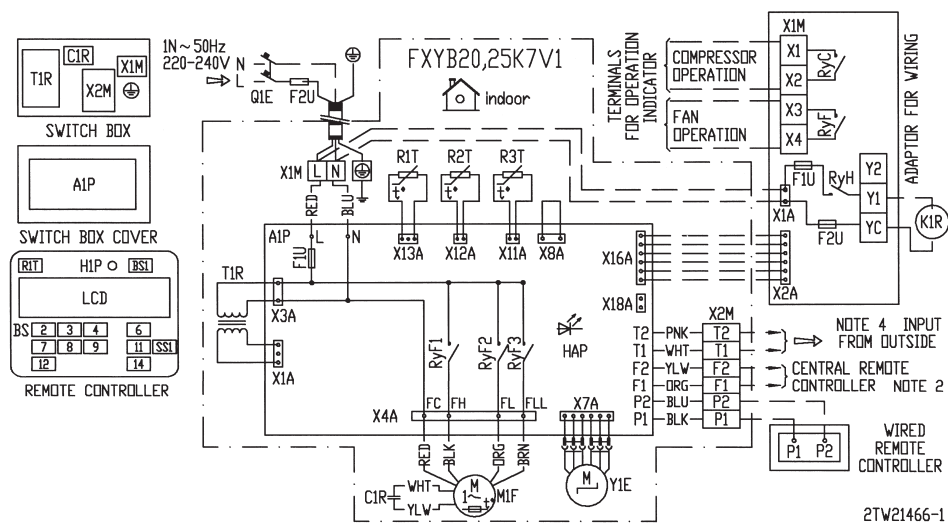

2TW21466-1

AIP	PRINTED CIRCUIT BOARD	FIU, F2U	FUSE (250V, 5A)
CIR	CAPACITOR (FAN)	X1A, X2A	CONNECTOR (WIRING ADAPTOR)
FIU	FUSE (250V, 10A)	X1M	TERMINAL STRIP
F2U	FIELD FUSE		CONNECTOR FOR OPTIONAL PARTS
HAP	LIGHT EMITTING DIODE (SERVICE MONITOR-GREEN)	X16A	CONNECTOR (WIRING ADAPTOR)
MIF	MOTOR (FAN)	X18A	CONNECTOR (WIRING ADAPTOR FOR ELECTRONICAL APPENDICES)
QIE	EARTH LEAK DETECTOR		WIRED REMOTE CONTROLLER
R1T	THERMISTOR (AIR)	BS1	ON/OFF BUTTON
R2T, R3T	THERMISTOR (REFRIGERANT)	BS2	TIMER MODE START/STOP BUTTON
RvF1-3	MAGNETIC RELAY (FAN)	BS3, BS8	PROGRAMMING TIME BUTTON
TIR	TRANSFORMER (220V/27V)	BS4, BS9	TEMPERATURE SETTING BUTTON
X1M	TERMINAL STRIP (POWER)	BS6	OPERATION MODE SELECTOR BUTTON
X2M	TERMINAL STRIP (CONTROL)	BS7	TIMER ON/OFF BUTTON
Y1E	ELECTRONIC EXPANSION VALVE	BS11	FAN SPEED CONTROL BUTTON
	OPTIONAL PARTS	BS12	INSPECTION/TEST OPERATION BUTTON
JIEH	ELECTRIC HEATER	BS14	FILTER SIGN RESET BUTTON
KIR	MAGNETIC RELAY (JIEH)	LCD	LIQUID CRYSTAL DISPLAY
	ADAPTOR FOR WIRING	HIP	LIGHT EMITTING DIODE (ON-RED)
RvC, RvF	MAGNETIC RELAY	R1T	THERMISTOR (AIR)
RvH	MAGNETIC RELAY (JIEH)	SS1	SELECTOR SWITCH (MAIN/SUB)

FIELD WIRING		COLORS			
L	LIVE	BLK	BLACK	PNK	PINK
N	NEUTRAL	BLU	BLUE	RED	RED
PE	PROTECTIVE EARTH (SCREW)	BRN	BROWN	WHT	WHITE
		ORG	ORANGE	YELW	YELLOW

NOTES :

1. USE COPPER CONDUCTORS ONLY.
2. WHEN USING THE CENTRAL REMOTE CONTROLLER, SEE MANUAL FOR CONNECTION TO THE UNIT.
3. WHEN INSTALLING THE ELECTRIC HEATER, CHANGE THE WIRING FOR THE HEATER CIRCUIT. THE MAIN POWER SUPPLY HAS TO BE SUPPLIED INDEPENDENTLY.
4. WHEN CONNECTING THE INPUT WIRES FROM OUTSIDE, "FORCED OFF" OR "ON/OFF" OPERATION CAN BE SELECTED BY THE REMOTE CONTROLLER. SEE INSTALLATION MANUAL FOR MORE DETAILS.

2TW21466-1

Все каталоги и инструкции здесь: <https://splitssystema48.ru/instrukcii-po-ekspluatatsii-kondicionerov.html>

